



# CMT EQUIPMENT

Everything you need to site - **FAST!**

MAJOR  
CONTRACTORS  
PRICE GUIDE  
2020/21

EDITION 11



OVER 6000  
PRODUCTS

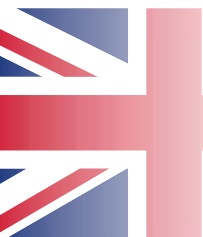

**SUPPORTING UK  
MANUFACTURING**

Various product lines developed and manufactured in the UK

020 8311 1144 | [sales@cmt.co.uk](mailto:sales@cmt.co.uk) | [www.cmt.co.uk](http://www.cmt.co.uk)

# OUR DELIVERY PROMISES

**GET IT ANYTIME!**



**Get it Anytime!**  
We can deliver 24 hours a day 7 days a week

Whether it's 2am in Manchester or Saturday evening in central London, we can deliver 24 hours a day, 7 days a week. Charges for this service apply so please discuss with our sales team who will get you the best price possible!

**GET IT NOW!**



**VIP Rapid 2 hour delivery to London & South East - call us for price**

Having teams on site without the equipment needed causes delays - we can deliver all standard catalogue lines with our rapid VIP 2 hour delivery. (If you require VIP delivery outside our area shown, just give us a call). Subject to availability.

**GET IT TODAY!**



**Order by 11am for Same Day Delivery to London & South East at no extra cost!**

Any orders received by 11am for delivery within our same day delivery area will be delivered same day at no extra cost. If you need same day delivery outside our area shown, no problem. Call our team to discuss.

**GET IT TOMORROW AM!**



**Order up to 7pm for next morning delivery nationwide at no extra cost!**

We are a flexible supplier. You can order from 6am to 7pm Monday to Friday. All orders placed by 7pm are delivered next day before midday as standard at no extra cost!\*

**GET IT IN IRELAND!**



**Get it in Ireland! Fast delivery available in Ireland from our Dublin depot**

We deliver your goods to you from our Dublin depot, too. If you require more details on the various services available please speak to our sales team today.



## 24 HOUR COLLECTION

**Collect from our UK depot**

London DA17 6AN

**Collect from our ROI depot**

Dublin D11 VX31



### TRUCK ICON DENOTES BULKY PRODUCT

Delivery charges and extended delivery times may apply. Call us for details.

**\*Here are our simple no-hassle delivery terms**

1. All services offered above are subject to our standard minimum order value of £150. A small order contribution of £8.95 will be added to any orders under £150 unless otherwise agreed with your account manager.
2. All services offered are for standard stock items. We endeavour to stock most items shown in this catalogue but from time to time some items may be out of stock and we will let you know at the time you place your order.
3. Order cutoff time for printed clothing orders is 3pm for next day delivery, and we cannot guarantee same day or VIP delivery on printed clothing. However we will endeavour to fulfil your requirements as quickly as we can.
4. Extra delivery charges may apply for deliveries to IOW, Isle Of Man, Channel Islands and parts of Ireland and Scotland.

Please note that printed and embroidered goods, and any goods ordered as a special are non-returnable under any circumstances and cannot be cancelled once the order has been processed. Standard goods from our catalogue can be returned providing goods are in perfect condition and in the original packaging, which will incur a minimum 15% restocking charge. Return requests must be submitted to our customer services department within 15 working days, and the goods returned to us within 20 working days. If you require us to collect the goods, a minimum collection charge of £15 will apply and will be calculated by location and volume.

All products offered in this catalogue are subject to our terms and conditions of sale. A copy of our terms and conditions is available on request. Due to constant product development we reserve the right to offer a product that differs from one represented in this catalogue. All product details including pricing are subject to change without prior notice. All prices exclude VAT where applicable.



# WELCOME

TO YOUR NEW 2020/21 - EDITION 11 CATALOGUE

We are delighted to present to you our brand new product guide for 2020/21. With new updated pages, hundreds of new products added, and an easy-to-use layout, this guide makes buying with CMT even more convenient for you.

All of this combined with our excellent service, highly competitive prices and FAST delivery makes CMT the best choice for all of your construction equipment and consumables.

We appreciate your business and look forward to hearing from you soon.

**TEAM CMT**



- 11** OTEC DIAMOND BLADES & CORES
- 39** CUTTING & DRILLING
- 51** GROUNDWORK TOOLS
- 85** HAND TOOLS
- 107** TOOL TETHERING
- 117** MEASURING & SURVEYING EQUIPMENT

- 127** DECORATING & SEALANTS
- 135** SITE EQUIPMENT
- 163** ELECTRICAL & LIGHTING
- 175** SITE PROTECTION
- 181** SITE FURNITURE & STATIONERY
- 189** COVID HYGIENE



189



431



331



479

203 JANITORIAL & CATERING

227 ENVIRONMENTAL

245 FIRE, ACCIDENT & EMERGENCY

259 PERSONAL PROTECTIVE EQUIPMENT

331 HI VIS CLOTHING & WORKWEAR

383 FIXINGS & FASTENERS

401 CONCRETE & FORMWORK ACCESSORIES

411 PLANT, POWER TOOLS & AUTOMOTIVE

431 SAFESMART ACCESS

445 SECURASITE

451 TRAFFIC MANAGEMENT

479 SAFETY SIGNS

# ABOUT US

CMT Group was born in 2010 with a small, dedicated, passionate team and a condensed product range.

We have grown fast to become one of the largest independent construction equipment suppliers in the UK, leading the industry in exemplary customer care and satisfaction.

From day one, service has been the backbone of CMT's success.

Despite the fast-paced and demanding nature of the industry, our focus has never deviated from customer care first and foremost.

With a carefully developed supply-chain where we manufacture and distribute in-house, we guarantee our clients will have the products they need – fast!

**We believe in offering the right product, at the right price, to the right place, at the right time.**

# WHY CHOOSE US?

CMT is not just another one of those typical suppliers with good prices and average service. We're a team of committed people who really care and offer the same personal touch every time.

We know how important it is for orders to arrive on time, it matters to us too.

As a well-established construction equipment supplier, we understand the importance of a simple and easy buying process. We provide a seamless experience for new and existing customers.

Through our account services we provide ongoing help and support, tailored pricing and bespoke

invoicing solutions – all of which aim at providing a sleek, unrivalled user experience.

We work closely with governing bodies and accomplished manufacturers to promote best practice at all times. Our manufacturing facilities are always providing our customers with

# OUR PROMISE

## Super-fast Delivery

We don't live in a perfect world; unfortunately, there will always be situations where goods are urgently required at short notice. That's why we provide deliveries same-day and next-morning nationwide as standard. Our own vehicle fleet is ever-expanding, delivering the vast majority of our orders nationwide and offering full flexibility & traceability every step of the journey. No matter where you are, we're just around the corner!

## Competitive Prices

Many wholesalers like to act as a simple middleman, they let brands and manufacturers do the talking. Whilst we proudly maintain strong relationships with affiliate brands, we don't stop there. In the market today, some brands get away with charging ludicrous prices. When we know that our inhouse R&D and manufacturing departments can do a better job, that's what we do - we produce a product that yields a similar or higher quality but for a fraction of the price. We're responsible for the quality of the product and that's how we like it.

## Socially Responsible

At CMT we take our operations very seriously and ensure all aspects of our company are exceptional. Our social responsibility is no different. We continuously quality check supply-chains and re-evaluate our environmental footprint. We use circular supply-chain concepts to offer advice to customers about disposing of products. It would not be right to call ourselves successful without having a strong CSR programme.

what's needed at the time, under any circumstance. 'In demand' products can be easily upscaled, new product lines can be developed and alterations and bespoke solutions can be provided.

**Whatever demands are put on us, we deliver.**

# OUR ETHOS

Our ethos is simple – extensive, adaptable product lines at competitive prices, while providing unbeatable service.

CMT's innovative business model was a breakthrough to an industry tired of long lead times and unpredictable deliveries. Our commitment to unrivalled service - on time every time - was a refreshing disruption to the market.

We like to put ourselves in the customer's shoes. We're openminded to new ways of working, we constantly push for feedback to better our service and we're not scared to take bold decisions where necessary.

**Our goal is to make our clients' lives simpler and easier.**

# QUALITY & COMPLIANCE YOU CAN TRUST

## At CMT we set the bar high.

Product quality is paramount. All products must comply with latest regulations and exceed industry best practice - it's imperative. As active members of the BSIF Registered Safety Supplier Scheme, we hold to strict guidelines that ensure high quality and compliance. We don't regard this as optional.

BSIF hold regular audits to ensure there's no compromise on quality or legal standards. As well as this, we manage product approval and certification in-house, giving us total control. Our experienced compliance team ensure all products stay compliant and up to date with current legislation, and can prove this for every item. Where relevant, this includes specification sheets, declarations of conformity and all associated documents.



## OUR NATIONWIDE DELIVERY FLEET

Our own vehicle fleet is constantly expanding, now delivering the vast majority of our orders nationwide and offering full flexibility & traceability every step of the journey. As we've expanded our network, we understand that it is essential that we deliver in a sustainable manner. Our ongoing transition to electric vehicles is a key part of our sustainability plan.

**We ship in bulk and consolidate deliveries whenever possible using specialist computer programmes for route mapping to not only ensure improved delivery times, but reduce our carbon emissions to the minimum.**

Our delivery methods are automatically calculated within our despatch software, and the processes utilised include the use of picking zones, twenty-four hour operations and staggered despatch times, allowing us to efficiently despatch thousands of orders a day.





# ARMED FORCES COVENANT

CMT have committed to honour the Armed Forces Covenant and support the Armed Forces Community. The first duty of Government is the defence of the realm. Our Armed Forces fulfil that responsibility, sacrificing some civilian freedoms, facing danger and, sometimes, suffering serious injury or death as a result of their duty. In return, the whole nation has a moral obligation to the members of the Naval Service, the Army and the Royal Air Force, together with their families. They deserve our respect and support, and fair treatment.

We recognise the value serving personnel, reservists, veterans and military families bring to our business and will strive to support the employment of veterans by seeking to uphold the principles of the Armed Forces Covenant.



## THE 5% CLUB

As a company operating in the UK, we are committed to this country's growth agenda. Against the current backdrop, we are aware of the chronic skills shortage and youth unemployment that the UK faces and acknowledge the importance of developing our people as both a business and social imperative. We aim to play a role in transforming the fortunes of young, talented people in the UK to ensure that the UK retains its reputation for innovation. As a member of The 5% Club, we are pledging to work towards having a minimum 5% of our UK workforce enrolled on formalised apprentice, sponsored student and/or graduate development schemes within the next 5 years.

We believe that by joining The 5% Club we will play a role in Britain's long term prosperity, benefitting both society and Britain's place in the world.

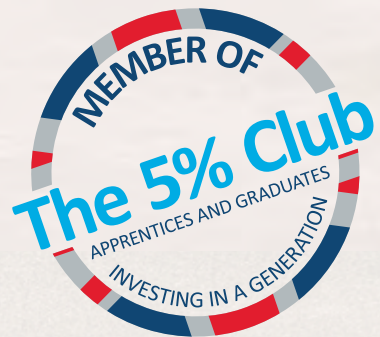

# RE: COVID-19 CRISIS

**We trust you are keeping safe during this difficult time. We wanted to provide an update on how COVID-19 has affected us, and the actions we've taken to ensure the service you receive is impeccable.**

Although procurement of some items has been extremely challenging in recent months, CMT have leveraged our supply network to find alternative high-quality sources where necessary and ensure a consistent and reliable supply to our clients. This has affected costs on certain items but, rest assured, we have and will continue to absorb these increases wherever possible. This means you can expect normal stock levels for all items. Our sales team will keep you personally advised at every point if any further global spikes in demand are experienced that may have an effect on supply.

Despite the economic difficulties, CMT are committed to protecting our workforce, meaning continuity for your team when contacting CMT. This has carried increased costs, including investments in hardware and systems to enable employees to work from home, to ensure service levels are maintained.

We have also significantly expanded our transport team and the area covered by our ever-expanding fleet. This means a further increased service level for the majority of the country and greater flexibility and traceability. This large investment has helped protect your service from negative impacts of third-party couriers, who have been affected by the crisis. As a result, we have been forced to increase our standard delivery charge to £12.95.

Despite international shortages, CMT are committed to playing our part to help and support our community. We've made over 50 donations of essential PPE to local NHS trusts, charities and care homes.

CMT remain in a financially strong position despite the current economic difficulties. Our future as your supply partner is secure. In the current climate, it's easy to forget about our obligations to protect the planet. However, we are continuing to stick to our resolve in ongoing environmental commitments and continuously work to reduce our CO2 footprint.

CMT remain committed to providing the highest level of service to you and your team. We trust you stay safe and well as we this recover from this crisis together and emerge stronger.

Take care, and speak soon!

**TEAM CMT**

# CMT are the **first UK** manufacturer to produce certified **Type II, IIR and 3-Ply** face masks

**No.1 UK  
Manufacturer  
of Certified  
Face Masks**

Our extensive knowledge of personal protective equipment and our commitment to leading innovations in safety, led us to start manufacturing surgical and standard use masks. Producing millions of masks per week with constant expansion to accommodate demand.

Masks are fully certified to EN14638:2019, with official certification and test reports in English - making it clear and simple to process through your own compliance systems.

Production facilities are based at the same complex as our head office, with over 400,000 sq. ft. of manufacturing and warehousing. Get in touch to book a visit, and see the manufacturing process from raw material to finished masks with your own eyes.



**Type II, IIR and 3-Ply face masks are available in a range of pack sizes and packaging options, including own branding**

Our focus is on helping you in guaranteeing a consistent, secure supply of UK manufactured masks at more competitive rates than offshore-sourced products.

**Benefits of ordering through an accredited UK supplier rather than importing:**

- Removes any risk of inconsistent supply
- Save weeks of time on delivery
- Deal with a professional UK team
- Avoid overstocking with reduced MOQs
- Supports UK manufacturing
- Avoid exchange rate fluctuations
- Supports our economy

Call us: **020 8311 1144**  
Email: [enquiries@cmtgroup.co.uk](mailto:enquiries@cmtgroup.co.uk)  
[www.cmtgroup.co.uk](http://www.cmtgroup.co.uk)



# ORDER ONLINE

[www.cmt.co.uk](http://www.cmt.co.uk)



- FastPoints loyalty scheme
- Products shown at your prices
- Sublogin option for employees
- Online order history
- Invoice & POD finder
- 24/7 ordering



# OTEC DIAMOND BLADES & CORES



Application Chart	<b>12-13</b>
Concrete	<b>16-19</b>
Hard Materials	<b>20-23</b>
Multi-Purpose	<b>24-27</b>
Asphalt	<b>28-29</b>
Brick Cutting	<b>30-31</b>
Ceramic, Porcelain	<b>33</b>
Stone	<b>34-35</b>
Wet & Dry Cores	<b>36-37</b>
Wet Cores	<b>38</b>

- ✓✓✓ HIGHLY RECOMMENDED
- ✓✓ RECOMMENDED (NOT CONTINUOUS USE)
- ✓ OCCASIONAL USE
- ✗ NOT RECOMMENDED



## CONSTRUCTION BLADES

QUALITY LEVEL	Blade Ref	METAL	VERY HARD
		Exposed steel, RSJ's and sheet metal	Granite, engineering bricks, hard clay products, hard natural stone, very hard concrete
STANDARD	D15TE	✗	✗
PREMIUM	D15D	✗	✗
	LT10	✓	✓✓✓
	D15T10	✗	✗
	D20T	✗	✗
SUPER PREMIUM	DT15	✗	✓
	Z15	✗	✓
	LT10R	✓✓	✓✓✓
	TX15	✗	✗
	D18	✗	✓
	D20B	✗	✗
PROFESSIONAL	Z15P	✗	✓✓✓
	DX05	✗	✓✓✓
	D10P	✓	✓✓✓
	DT150	✗	✓
	L5P	✓✓	✓✓✓
	D18P	✗	✓
	X19P	✗	✗
	D20	✗	✗
	D20P	✗	✗
	USB	✓✓✓	✓

## SPECIALIST BRICK CUTTING BLADES

QUALITY LEVEL	Blade Ref	Soft Brick	Medium Brick	Hard Brick	Ultra Hard Brick
PROFESSIONAL	W19	✓✓✓	✗	✗	✗
	W19SC	✓✓✓	✗	✗	✗
	W7	✓✓	✓✓✓	✓✓	✓
	W7SC	✓✓	✓✓✓	✓✓	✓
	W6SC	✓	✓✓	✓✓✓	✓✓✓
	W63P	✓	✓✓	✓✓✓	✓✓
	W5SC	✗	✓	✓✓	✓✓✓

# APPLICATION CHART

STANDARD	ENTRY LEVEL CONSTRUCTORS RANGE
PREMIUM	EXCEPTIONAL VALUE FOR THE PRICE CONSCIOUS BUYER WHO WANTS SOMETHING BETTER
SUPER PREMIUM	BEST SELLING SUPERIOR BLADES FOR EXCELLENT PERFORMANCE
PROFESSIONAL	WHEN NOTHING BUT THE BEST WILL DO - GUARANTEED TO OUT PERFORM

CONCRETE	GENERAL PURPOSE	ABRASIVE	ASPHALT
Limestone and flint aggregate, reinforced concrete, hard unabrasive concrete products	Kerbs and slabs, medium hard bricks, yorkstone, concrete paviers	Concrete roof tiles, sandstone, abrasive, concrete paviers	Asphalt, green concrete, render, cement screed, lignacite blocks
✓✓	✓✓✓✓	✓✓	✗
✓✓	✓✓✓✓	✓✓	✗
✓✓✓	✓✓✓✓	✓	✗
✓✓	✓✓✓✓	✓✓	✓
✗	✗	✓	✓✓✓
✓✓✓	✓✓✓	✓✓	✗
✓✓✓	✓✓✓	✓	✗
✓✓✓	✓✓✓	✓	✗
✓✓✓	✓✓✓	✓✓✓	✓
✗	✗	✓	✓✓✓
✓✓✓	✓✓✓	✓	✗
✓✓✓	✓✓✓	✓	✗
✓✓	✓✓	✗	✗
✓✓✓	✓✓✓	✓	✗
✓✓✓	✓✓✓	✓	✗
✓✓✓	✓✓✓	✓✓✓	✓✓
✓	✓✓	✓✓✓	✓✓✓
✗	✗	✓	✓✓✓
✗	✗	✓	✓✓✓
✓	✓	✓	✗

## CERAMIC, PORCELAIN & STONE

QUALITY LEVEL	Blade Ref	Ceramic	Porcelain	Granite	Marble	Quartz	Hard Clay
PROFESSIONAL	R20	✓✓✓	✓✓	✓✓	✓✓	✓✓	✓✓
	PC10	✓✓	✓✓✓	✓✓	✗	✓✓	✓
	SP5V	✗	✗	✓✓✓	✓✓✓	✓✓	✗
	ST5L	✗	✗	✓✓✓	✓✓✓	✓✓	✗
	D5P	✓	✓✓	✓✓✓	✗	✓✓	✓✓✓
	L5P	✓✓	✓	✓✓✓	✗	✓	✓✓✓
	E40V	✗	✗	✗	✓✓✓	✗	✗
	TR30V	✗	✗	✗	✓✓✓	✗	✗
	W5SC	✗	✗	✓✓✓	✗	✓✓✓	✗
	W5XSC	✗	✗	✓✓✓	✗	✓✓✓	✗
W40SC	✗	✗	✗	✓✓✓	✗	✗	

ORDER 6AM TO 7PM FOR NEXT MORNING DELIVERY

Set up an account for our discounted rates / prices

# OTEC DIAMOND BLADES

*a cut above the rest*

Since 1992 OTEC diamond blades have been leading the field in the supply of professional diamond tools to the construction and civil engineering industry, and we're proud to be the number one brand in the marketplace.

OTEC diamond blades have been proven throughout the last 28 years to provide high performance and durability, with an excellent track record of safety. These three key features are the reason OTEC are the approved diamond tool brand to so many of the UK's biggest contractors.

SUPPLYING WORLD CLASS **BLADES**

**SINCE**  
**1992**







#PERFORMANCE  
#DURABILITY  
#SAFETY



**OTEC**<sup>TM</sup>  
a cut above the rest

# D15TE

# STANDARD



<b>METAL</b> Exposed steel, RSJ's, sheet metal, ductile iron pipe, rebar, fibreglass, plastic pipe	✗
<b>VERY HARD</b> Granite, Engineering bricks, hard clay products, hard natural stone, very hard concrete	✗
<b>CONCRETE</b> Limestone and flint aggregate, reinforced concrete, hard unabrasive concrete products	✓✓
<b>GENERAL PURPOSE</b> Kerbs and slabs, medium hard bricks, yorkstone, concrete paviors	✓✓✓✓
<b>ABRASIVE</b> Concrete roof tiles, sandstone, abrasive concrete paviors	✓✓
<b>ASPHALT</b> Asphalt, green concrete, render, cement screed, lignacite blocks	✗



Safety Standard



Segment Size

CODE	DIAMETER	BORE	
D15TE-300/20	300mm	20mm	10

# D15D

# PREMIUM



<b>METAL</b> Exposed steel, RSJ's, sheet metal, ductile iron pipe, rebar, fibreglass, plastic pipe	✗
<b>VERY HARD</b> Granite, Engineering bricks, hard clay products, hard natural stone, very hard concrete	✗
<b>CONCRETE</b> Limestone and flint aggregate, reinforced concrete, hard unabrasive concrete products	✓✓
<b>GENERAL PURPOSE</b> Kerbs and slabs, medium hard bricks, yorkstone, concrete paviors	✓✓✓✓
<b>ABRASIVE</b> Concrete roof tiles, sandstone, abrasive concrete paviors	✓✓
<b>ASPHALT</b> Asphalt, green concrete, render, cement screed, lignacite blocks	✗



Safety Standard



Segment Size

CODE	DIAMETER	BORE	
D15D-300/20	300mm	20mm	10

# CONCRETE

## SUPER PREMIUM

## TX15

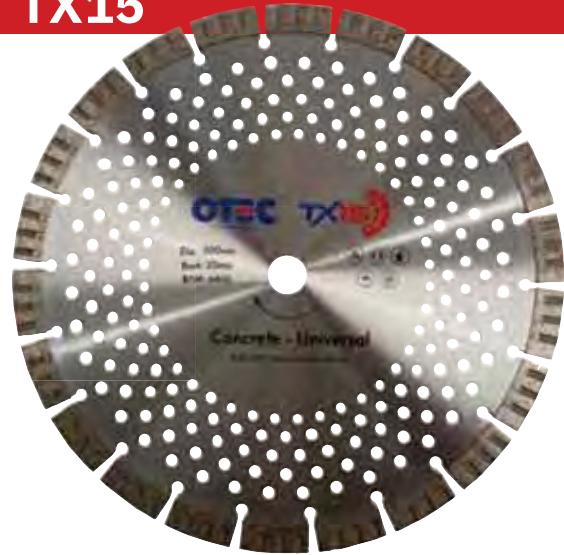

<b>METAL</b> Exposed steel, RSJ's, sheet metal, ductile iron pipe, rebar, fibreglass, plastic pipe	✗
<b>VERY HARD</b> Granite, Engineering bricks, hard clay products, hard natural stone, very hard concrete	✗
<b>CONCRETE</b> Limestone and flint aggregate, reinforced concrete, hard unabrasive concrete products	✓✓✓
<b>GENERAL PURPOSE</b> Kerbs and slabs, medium hard bricks, yorkstone, concrete paviors	✓✓✓
<b>ABRASIVE</b> Concrete roof tiles, sandstone, abrasive concrete paviors	✓✓
<b>ASPHALT</b> Asphalt, green concrete, render, cement screed, lignacite blocks	✗

CODE	DIAMETER	BORE	
TX15-300/20	300mm	20mm	10



## SUPER PREMIUM

## Z15



<b>METAL</b> Exposed steel, RSJ's, sheet metal, ductile iron pipe, rebar, fibreglass, plastic pipe	✗
<b>VERY HARD</b> Granite, Engineering bricks, hard clay products, hard natural stone, very hard concrete	✓
<b>CONCRETE</b> Limestone and flint aggregate, reinforced concrete, hard unabrasive concrete products	✓✓✓
<b>GENERAL PURPOSE</b> Kerbs and slabs, medium hard bricks, yorkstone, concrete paviors	✓✓✓
<b>ABRASIVE</b> Concrete roof tiles, sandstone, abrasive concrete paviors	✓
<b>ASPHALT</b> Asphalt, green concrete, render, cement screed, lignacite blocks	✗

CODE	DIAMETER	BORE		
Z15-300/20	300mm	20mm	10mm seg	10
Z15-350/25	350mm	25mm	8mm seg	10
Z15-450/25	450mm	25mm	8mm seg	10



ORDER 6AM TO 7PM FOR NEXT MORNING DELIVERY

Set up an account for our discounted rates / prices

# DT15

# SUPER PREMIUM

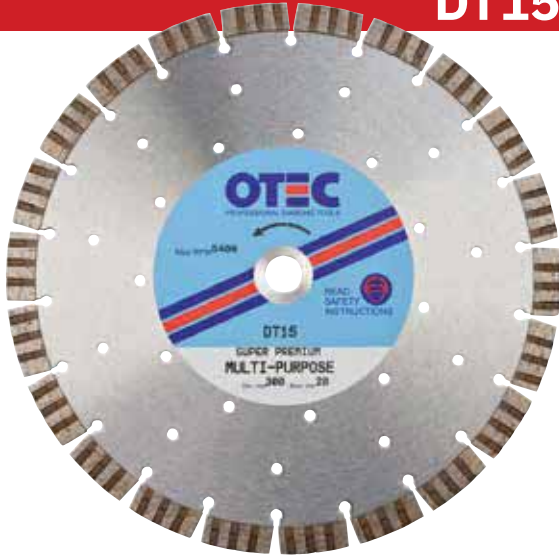

<b>METAL</b> Exposed steel, RSJ's, sheet metal, ductile iron pipe, rebar, fibreglass, plastic pipe	✗
<b>VERY HARD</b> Granite, Engineering bricks, hard clay products, hard natural stone, very hard concrete	✓✓
<b>CONCRETE</b> Limestone and flint aggregate, reinforced concrete, hard unabrasive concrete products	✓✓✓✓
<b>GENERAL PURPOSE</b> Kerbs and slabs, medium hard bricks, yorkstone, concrete paviors	✓✓✓✓
<b>ABRASIVE</b> Concrete roof tiles, sandstone, abrasive concrete paviors	✓✓
<b>ASPHALT</b> Asphalt, green concrete, render, cement screed, lignacite blocks	✗



CODE	DIAMETER	BORE	
DT15-105/16	105mm	16mm	10
DT15-115/22	115mm	22mm	10
DT15-125/22	125mm	22mm	10
DT15-300/20	300mm	20mm	10

# DX05

# PROFESSIONAL



<b>METAL</b> Exposed steel, RSJ's, sheet metal, ductile iron pipe, rebar, fibreglass, plastic pipe	✗
<b>VERY HARD</b> Granite, Engineering bricks, hard clay products, hard natural stone, very hard concrete	✓✓
<b>CONCRETE</b> Limestone and flint aggregate, reinforced concrete, hard unabrasive concrete products	✓✓✓✓
<b>GENERAL PURPOSE</b> Kerbs and slabs, medium hard bricks, yorkstone, concrete paviors	✓✓✓✓
<b>ABRASIVE</b> Concrete roof tiles, sandstone, abrasive concrete paviors	✓
<b>ASPHALT</b> Asphalt, green concrete, render, cement screed, lignacite blocks	✗



CODE	DIAMETER	BORE	
DX05-300/20	300mm	20mm	10
DX05-350/20	350mm	20mm	10

# CONCRETE

## PROFESSIONAL

## Z15P

<b>METAL</b> Exposed steel, RSJ's, sheet metal, ductile iron pipe, rebar, fibreglass, plastic pipe	✗
<b>VERY HARD</b> Granite, Engineering bricks, hard clay products, hard natural stone, very hard concrete	✓
<b>CONCRETE</b> Limestone and flint aggregate, reinforced concrete, hard unabrasive concrete products	✓✓✓
<b>GENERAL PURPOSE</b> Kerbs and slabs, medium hard bricks, yorkstone, concrete paviors	✓✓✓
<b>ABRASIVE</b> Concrete roof tiles, sandstone, abrasive concrete paviors	✓✓
<b>ASPHALT</b> Asphalt, green concrete, render, cement screed, lignacite blocks	✗



**\*8MM, 10MM, & 12MM WIDE LOOPING BLADES AVAILABLE - PLEASE ASK OUR SALES TEAM\***



CODE	DIAMETER	BORE		
Z15P-300/20	300mm	20mm	12mm seg	10
Z15P-350/25	350mm	25mm	10mm seg	10
Z15P-450/25	450mm	25mm	10mm seg	10

ORDER **6AM TO 7PM** FOR NEXT MORNING DELIVERY

Set up an account for our discounted rates / prices

# LT10

# PREMIUM



<b>METAL</b> Exposed steel, RSJ's, sheet metal, ductile iron pipe, rebar, fibreglass, plastic pipe	✓
<b>VERY HARD</b> Granite, Engineering bricks, hard clay products, hard natural stone, very hard concrete	✓✓✓
<b>CONCRETE</b> Limestone and flint aggregate, reinforced concrete, hard unabrasive concrete products	✓✓✓
<b>GENERAL PURPOSE</b> Kerbs and slabs, medium hard bricks, yorkstone, concrete paviors	✓✓✓
<b>ABRASIVE</b> Concrete roof tiles, sandstone, abrasive concrete paviors	✓
<b>ASPHALT</b> Asphalt, green concrete, render, cement screed, lignacite blocks	✗



CODE	DIAMETER	BORE	
LT10-300/20	300mm	20mm	10

# L5P

# PROFESSIONAL



<b>METAL</b> Exposed steel, RSJ's, sheet metal, ductile iron pipe, rebar, fibreglass, plastic pipe	✓✓
<b>VERY HARD</b> Granite, Engineering bricks, hard clay products, hard natural stone, very hard concrete	✓✓✓
<b>CONCRETE</b> Limestone and flint aggregate, reinforced concrete, hard unabrasive concrete products	✓✓✓
<b>GENERAL PURPOSE</b> Kerbs and slabs, medium hard bricks, yorkstone, concrete paviors	✓✓✓
<b>ABRASIVE</b> Concrete roof tiles, sandstone, abrasive concrete paviors	✓
<b>ASPHALT</b> Asphalt, green concrete, render, cement screed, lignacite blocks	✗



CODE	DIAMETER	BORE	
L5P-125/22	125mm	22mm	10
L5P-150/22	150mm	22mm	10
L5P-300/20	300mm	20mm	10
L5P-350/25	150mm	25mm	10

## SUPER PREMIUM

## LT10R



<b>METAL</b> Exposed steel, RSJ's, sheet metal, ductile iron pipe, rebar, fibreglass, plastic pipe	✓✓
<b>VERY HARD</b> Granite, Engineering bricks, hard clay products, hard natural stone, very hard concrete	✓✓✓
<b>CONCRETE</b> Limestone and flint aggregate, reinforced concrete, hard unabrasive concrete products	✓✓✓
<b>GENERAL PURPOSE</b> Kerbs and slabs, medium hard bricks, yorkstone, concrete paviors	✓✓✓
<b>ABRASIVE</b> Concrete roof tiles, sandstone, abrasive concrete paviors	✓
<b>ASPHALT</b> Asphalt, green concrete, render, cement screed, lignacite blocks	✗



CODE	DIAMETER	BORE	
LT10R-105/16	105mm	16mm	10
LT10R-115/22	115mm	22mm	10
LT10R-125/22	125mm	22mm	10
LT10R-150/22	150mm	22mm	10
LT10R-230/22	230mm	22mm	10
LT10R-300/20	300mm	20mm	10
LT10R-350/20	350mm	20mm	10
LT10R-350/25	350mm	25mm	10

ORDER 6AM TO 7PM FOR NEXT MORNING DELIVERY

Set up an account for our discounted rates / prices

# D10P

# PROFESSIONAL



<b>METAL</b> Exposed steel, RSJ's, sheet metal, ductile iron pipe, rebar, fibreglass, plastic pipe	✓
<b>VERY HARD</b> Granite, Engineering bricks, hard clay products, hard natural stone, very hard concrete	✓✓✓
<b>CONCRETE</b> Limestone and flint aggregate, reinforced concrete, hard unabrasive concrete products	✓✓
<b>GENERAL PURPOSE</b> Kerbs and slabs, medium hard bricks, yorkstone, concrete paviors	✓✓
<b>ABRASIVE</b> Concrete roof tiles, sandstone, abrasive concrete paviors	✗
<b>ASPHALT</b> Asphalt, green concrete, render, cement screed, lignacite blocks	✗



CODE	DIAMETER	BORE	
D10P-230/22	230mm	22mm	10
D10P-300/20	300mm	20mm	10
D10P-350/20	350mm	20mm	10
D10P-350/25	350mm	25mm	10



# HARD MATERIALS

## PROFESSIONAL

## PC10

CERAMIC	✓✓
PORCELAIN	✓✓✓
GRANITE	✓✓
MARBLE	✗
QUARTZ	✓✓
HARD CLAY PRODUCTS	✓



CODE	DIAMETER	BORE	
PC10-115/22	115mm	22mm	10
PC10-125/22	125mm	22mm	10
PC10-300/25/20	300mm	20mm	10
PC10-350/25	350mm	25mm	10



## PROFESSIONAL

## DT150

<b>METAL</b> Exposed steel, RSJ's, sheet metal, ductile iron pipe, rebar, fibreglass, plastic pipe	✗
<b>VERY HARD</b> Granite, Engineering bricks, hard clay products, hard natural stone, very hard concrete	✓✓✓
<b>CONCRETE</b> Limestone and flint aggregate, reinforced concrete, hard unabrasive concrete products	✓✓✓
<b>GENERAL PURPOSE</b> Kerbs and slabs, medium hard bricks, yorkstone, concrete paviors	✓✓✓
<b>ABRASIVE</b> Concrete roof tiles, sandstone, abrasive concrete paviors	✓
<b>ASPHALT</b> Asphalt, green concrete, render, cement screed, lignacite blocks	✗



**\*THIS BLADE SHOULD NOT BE USED FOR CLAY PIPE\***

CODE	DIAMETER	BORE	
DT150-300/20	300mm	20mm	10



ORDER **6AM TO 7PM** FOR NEXT MORNING DELIVERY

Set up an account for our discounted rates / prices

# D15T10

# PREMIUM



<b>METAL</b> Exposed steel, RSJ's, sheet metal, ductile iron pipe, rebar, fibreglass, plastic pipe	✗
<b>VERY HARD</b> Granite, Engineering bricks, hard clay products, hard natural stone, very hard concrete	✓
<b>CONCRETE</b> Limestone and flint aggregate, reinforced concrete, hard unabrasive concrete products	✓✓
<b>GENERAL PURPOSE</b> Kerbs and slabs, medium hard bricks, yorkstone, concrete paviors	✓✓✓
<b>ABRASIVE</b> Concrete roof tiles, sandstone, abrasive concrete paviors	✓✓
<b>ASPHALT</b> Asphalt, green concrete, render, cement screed, lignacite blocks	✓



CODE	DIAMETER	BORE	
D15T10-115/22	115mm	22mm	10
D15T10-230/22	230mm	22mm	10
D15T10-300/20	300mm	20mm	10
D15T10-350/20	350mm	20mm	10
D15T10-350/25	350mm	25mm	10

# MULTI PURPOSE

## SUPER PREMIUM

## D18



<p><b>METAL</b></p> <p>Exposed steel, RSJ's, sheet metal, ductile iron pipe, rebar, fibreglass, plastic pipe</p>	✗
<p><b>VERY HARD</b></p> <p>Granite, Engineering bricks, hard clay products, hard natural stone, very hard concrete</p>	✓
<p><b>CONCRETE</b></p> <p>Limestone and flint aggregate, reinforced concrete, hard unabrasive concrete products</p>	✓✓✓
<p><b>GENERAL PURPOSE</b></p> <p>Kerbs and slabs, medium hard bricks, yorkstone, concrete paviors</p>	✓✓✓
<p><b>ABRASIVE</b></p> <p>Concrete roof tiles, sandstone, abrasive concrete paviors</p>	✓✓✓
<p><b>ASPHALT</b></p> <p>Asphalt, green concrete, render, cement screed, lignacite blocks</p>	✓



CODE	DIAMETER	BORE	
D18-300/20	300mm	20mm	10
D18-350/25	350mm	25mm	10
D18-400/20	400mm	20mm	10
D18-400/25	400mm	25mm	10
D18-450/25	450mm	25mm	10

ORDER 6AM TO 7PM FOR NEXT MORNING DELIVERY

Set up an account for our discounted rates / prices

# D18P

# PROFESSIONAL



<p><b>METAL</b></p> <p>Exposed steel, RSJ's, sheet metal, ductile iron pipe, rebar, fibreglass, plastic pipe</p>	✗
<p><b>VERY HARD</b></p> <p>Granite, Engineering bricks, hard clay products, hard natural stone, very hard concrete</p>	✓
<p><b>CONCRETE</b></p> <p>Limestone and flint aggregate, reinforced concrete, hard unabrasive concrete products</p>	✓✓✓
<p><b>GENERAL PURPOSE</b></p> <p>Kerbs and slabs, medium hard bricks, yorkstone, concrete paviors</p>	✓✓✓
<p><b>ABRASIVE</b></p> <p>Concrete roof tiles, sandstone, abrasive concrete paviors</p>	✓✓✓
<p><b>ASPHALT</b></p> <p>Asphalt, green concrete, render, cement screed, lignacite blocks</p>	✓✓



CODE	DIAMETER	BORE	
D18P-115/22	115mm	22mm	10
D18P-230/22	230mm	22mm	10
D18P-300/20	300mm	20mm	10
D18P-350/20	350mm	20mm	10
D18P-350/25	350mm	25mm	10
D18P-450/25	450mm	25mm	10
D18P-600/25	600mm	25mm	10

# MULTI PURPOSE

## PROFESSIONAL

## X19P

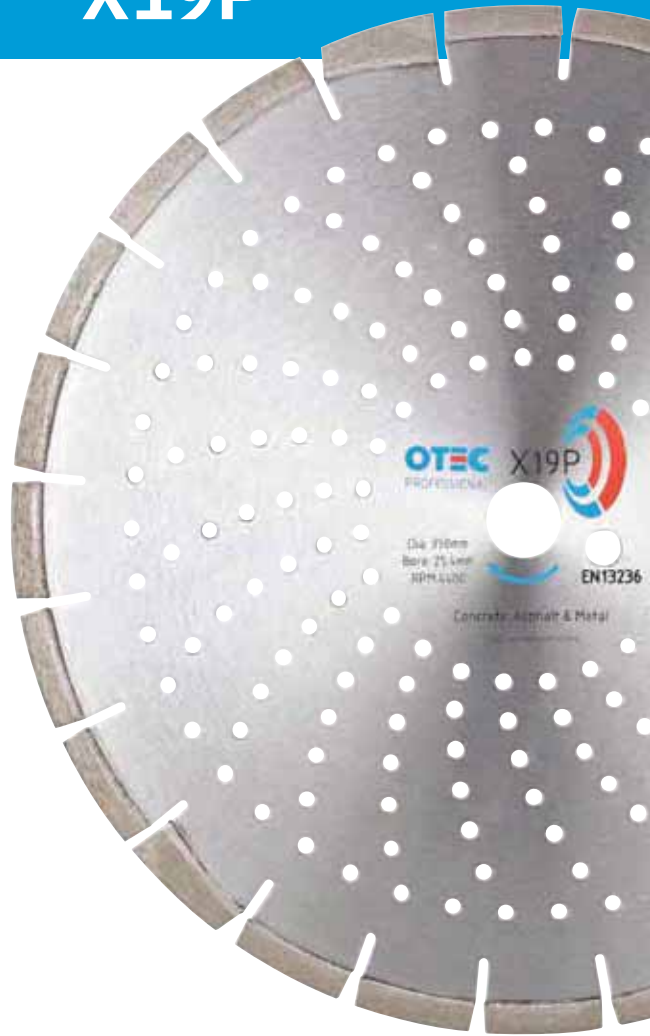

<b>METAL</b> Exposed steel, RSJ's, sheet metal, ductile iron pipe, rebar, fibreglass, plastic pipe	✗
<b>VERY HARD</b> Granite, Engineering bricks, hard clay products, hard natural stone, very hard concrete	✗
<b>CONCRETE</b> Limestone and flint aggregate, reinforced concrete, hard unabrasive concrete products	✓
<b>GENERAL PURPOSE</b> Kerbs and slabs, medium hard bricks, yorkstone, concrete paviors	✓✓
<b>ABRASIVE</b> Concrete roof tiles, sandstone, abrasive concrete paviors	✓✓✓
<b>ASPHALT</b> Asphalt, green concrete, render, cement screed, lignacite blocks	✓✓✓



CODE	DIAMETER	BORE	
X19P-300/20	300mm	20mm	10
X19P-350/20	350mm	20mm	10
X19P-350/25	350mm	25mm	10
X19P-450/25	450mm	25mm	10

ORDER **6AM TO 7PM** FOR NEXT MORNING DELIVERY

Set up an account for our discounted rates / prices

# D20B

# SUPER PREMIUM



<b>METAL</b> Exposed steel, RSJ's, sheet metal, ductile iron pipe, rebar, fibreglass, plastic pipe	✗
<b>VERY HARD</b> Granite, Engineering bricks, hard clay products, hard natural stone, very hard concrete	✗
<b>CONCRETE</b> Limestone and flint aggregate, reinforced concrete, hard unabrasive concrete products	✗
<b>GENERAL PURPOSE</b> Kerbs and slabs, medium hard bricks, yorkstone, concrete paviors	✗
<b>ABRASIVE</b> Concrete roof tiles, sandstone, abrasive concrete paviors	✓
<b>ASPHALT</b> Asphalt, green concrete, render, cement screed, lignacite blocks	✓✓✓



CODE	DIAMETER	BORE	
D20B-300/20	300mm	20mm	10
D20B-350/25	350mm	25mm	10
D20B-450/25	450mm	25mm	10

# ASPHALT

## PROFESSIONAL

## D20



<p><b>METAL</b></p> <p>Exposed steel, RSJ's, sheet metal, ductile iron pipe, rebar, fibreglass, plastic pipe</p>	✗
<p><b>VERY HARD</b></p> <p>Granite, Engineering bricks, hard clay products, hard natural stone, very hard concrete</p>	✗
<p><b>CONCRETE</b></p> <p>Limestone and flint aggregate, reinforced concrete, hard unabrasive concrete products</p>	✗
<p><b>GENERAL PURPOSE</b></p> <p>Kerbs and slabs, medium hard bricks, yorkstone, concrete paviors</p>	✗
<p><b>ABRASIVE</b></p> <p>Concrete roof tiles, sandstone, abrasive concrete paviors</p>	✓
<p><b>ASPHALT</b></p> <p>Asphalt, green concrete, render, cement screed, lignacite blocks</p>	✓✓✓

**\*8MM, 10MM, & 12MM WIDE LOOPING BLADES AVAILABLE - PLEASE ASK OUR SALES TEAM\***



CODE	DIAMETER	BORE		
D20-300/20	300mm	20mm	10mm Seg	10
D20-350/20	350mm	25mm	8mm Seg	10
D20-450/25	450mm	25mm	8mm Seg	10

ORDER **6AM TO 7PM** FOR NEXT MORNING DELIVERY

Set up an account for our discounted rates / prices



### W19B - Premium

- Soft bricks, clean cutting, long life
- 9mm segment

Code	Diameter	Bore	
<b>W19B-350/25</b>	350mm	25mm	10



### W19 - Professional

- Soft bricks, clean cutting, very long life, top quality, 8mm segment

Code	Diameter	Bore	
<b>W19-350/25</b>	350mm	25mm	10
<b>W19-450/25</b>	450mm	25mm	10

### W19SC - Professional - Silent Centre

- Soft bricks, clean cutting, very long life, top quality, 8mm segment

Code	Diameter	Bore	
<b>W19SC-350/25</b>	350mm	25mm	10
<b>W19SC-450/25</b>	450mm	25mm	10



## RESPIRATORY PRODUCTS

LARGE RANGE  
AVAILABLE  
GO TO PAGES  
308-319





# BRICK CUTTING



## W7 - Professional

- Medium hard bricks, engineering bricks, top quality, 10mm segment

Code	Diameter	Bore	
W7-350/25	350mm	25mm	10
W7-450/25	450mm	25mm	10

## W7SC - Professional - Silent Centre

- Medium hard bricks, engineering bricks, top quality, 10mm segment

Code	Diameter	Bore	
W7SC-350/25	350mm	25mm	10
W7SC-450/25	450mm	25mm	10



## W6SC - Professional - Silent Centre

- Extremely hard bricks, very clean cutting, without chipping
- High quality, 10mm segment

Code	Diameter	Bore	
W6SC-350/25	350mm	25mm	10
W6SC-450/25	450mm	25mm	10
W6SC-600/25	600mm	25mm	10



## W63P - Professional Hard Brick

- Extremely hard bricks, very clean cutting without chipping
- 3mm wide segment with narrow gullet

Code	Diameter	Bore	
W63P-600/35/25	600mm	25mm	1

# CHECK OUT OUR RANGE OF **CUT-OFF SAWS**

**HAVE  
YOU  
SEEN?**

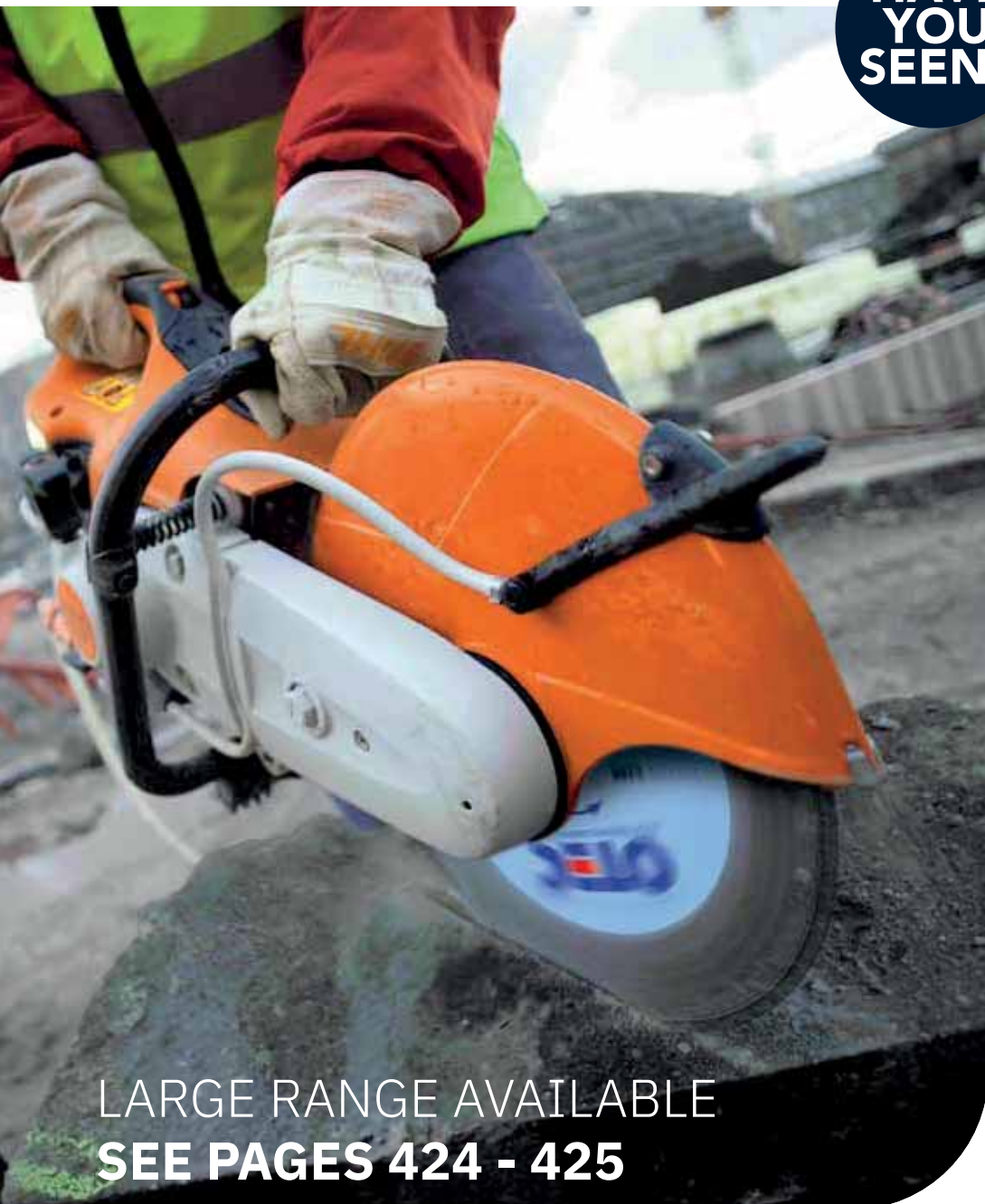

LARGE RANGE AVAILABLE  
**SEE PAGES 424 - 425**

# CERAMIC, PORCELAIN



## R20 - Professional

- Cuts all tiles guaranteed, fine cut no splintering, silencing S-slot
- 8mm segment

Code	Diameter	Bore	
<b>R20-300/20</b>	300mm	20mm	10
<b>R20-350/25</b>	350mm	25mm	10



## PC10 - Professional

- Porcelain, fine cut, ceramics, granite, natural stone
- Super thin, 7mm

Code	Diameter	Bore	
<b>PC10-115/22</b>	115mm	22mm	10
<b>PC10-125/22</b>	125mm	22mm	10
<b>PC10-300/20</b>	300mm	20mm	10
<b>PC10-350/25</b>	350mm	25mm	10



## SP5V - Professional - Turbo Diamond Blade - M14

- Granite and marble
- Turbo spiro segmented

Code	Diameter	Bore	
<b>SP5V-125/M14</b>	125mm	M14 Flange	10
<b>SP5V-230/M14</b>	230mm	M14 Flange	10



## ST5L - Professional - Turbo Diamond Blade - M14

- Granite and marble
- Turbo semi-continuous design

Code	Diameter	Bore	
<b>ST5L-125/M14</b>	125mm	M14 Flange	10
<b>ST5L-230/M14</b>	230mm	M14 Flange	10



### D5P - Professional

- Granite and hard stone
- Top quality, clean cut, 10mm segment

Code	Diameter	Bore	
D5P-125/22	125mm	22mm	10
D5P-150/22	150mm	22mm	10
D5P-180/22	180mm	22mm	10
D5P-230/22	230mm	22mm	10



### L5P- Professional

- Granite & clay products, ceramic tiles, natural stone
- Turbo rim, 12mm segment

Code	Diameter	Bore	
L5P-115/22	115mm	22mm	10
L5P-125/22	125mm	22mm	10
L5P-150/22	150mm	22mm	10
L5P-180/22	180mm	22mm	10
L5P-300/20	300mm	20mm	10
L5P-350/25	350mm	25mm	10



### E40V - Professional

- Diamond electroplated sides for cutting curves, very clean cut, marble
- Vanity blade

Code	Diameter	Bore	
E40V-125/22	125mm	22mm	10
E40V-150/22	150mm	22mm	10

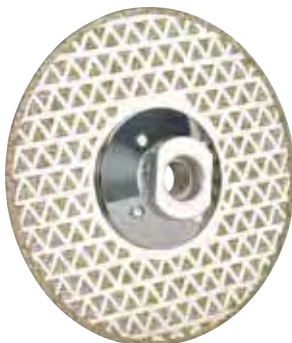

### TR30V - Professional - Electro Vanity Blade - M14

- Granite and marble
- With triangle electroplated design. For mounting directly on grinder

Code	Diameter	Bore	
TR30V-125/M14	125mm	M14 Flange	10
TR30V-230/M14	230mm	M14 Flange	10

# STONE

## W5SC

- Granite, quartz and hard stone
- High quality, clean cut, 15mm segment



Code	Diameter	Bore		
<b>W5SC-400/60/50</b>	400mm	50/60mm		10
<b>W5SC-450/60/50</b>	450mm	50/60mm		10
<b>W5SC-500/60/50</b>	500mm	50/60mm		10
<b>W5SC-600/60/50</b>	600mm	50/60mm		10

## ARIX

- Granite and hard stone
- Auto array, 15mm segment



Code	Diameter	Bore		
<b>ARIX-400</b>	400mm	50/60mm		10
<b>ARIX-450</b>	450mm	50/60mm		10
<b>ARIX-500</b>	500mm	50/60mm		10

## W40SC

- Marble
- High quality, clean cut, 8mm segment



Code	Diameter	Bore		
<b>W40SC-400/60/50</b>	400mm	50/60mm		10
<b>W40SC-450/60/50</b>	450mm	50/60mm		10
<b>W40SC-500/60/50</b>	500mm	50/60mm		10

## W5SCL - Professional Milling Blade

- Granite & hard stone, high quality segment for milling



Code	Diameter	Bore	Seg. Width	
<b>W5SCL-350-10W</b>	350mm	50/60mm	10mm	1
<b>W5SCL-350-15W</b>	450mm	50/60mm	15mm	1
<b>W5SCL-350-20W</b>	350mm	50/60mm	20mm	1
<b>W5SCL-350-25W</b>	450mm	50/60mm	25mm	1
<b>W5SCL-350-30W</b>	350mm	50/60mm	30mm	1
<b>W5SCL-400-8W</b>	450mm	50/60mm	8mm	1
<b>W5SCL-400-10W</b>	400mm	50/60mm	10mm	1
<b>W5SCL-400-20W</b>	400mm	50/60mm	20mm	1
<b>W5SCL-400-25W</b>	400mm	50/60mm	25mm	1
<b>W5SCL-400-30W</b>	400mm	50/60mm	30mm	1



## VBC Vacuum Brazed Drill

- Granite & marble, precision vacuum brazed 50mm length
- Wet core for mounting directly on angle grinder

Code	Diameter	Length	Fitting	
<b>VBC-006/M14</b>	6mm	40mm	M14	1
<b>VBC-010/M14</b>	10mm	40mm	M14	1
<b>VBC-015/M14</b>	15mm	40mm	M14	1
<b>VBC-020/M14</b>	20mm	40mm	M14	1
<b>VBC-025/M14</b>	25mm	40mm	M14	1
<b>VBC-030/M14</b>	30mm	40mm	M14	1
<b>VBC-035/M14</b>	35mm	40mm	M14	1
<b>VBC-040/M14</b>	40mm	40mm	M14	1
<b>VBC-045/M14</b>	45mm	40mm	M14	1
<b>VBC-055/M14</b>	55mm	40mm	M14	1
<b>VBC-060/M14</b>	60mm	40mm	M14	1
<b>VBC-065/M14</b>	65mm	40mm	M14	1



## DCG- Professional

- Universal / concrete, construction products, stone
- Double row

Code	Diameter	Bore	
<b>DCG-105/22</b>	105mm	22mm	36
<b>DCG-115/22</b>	115mm	22mm	36
<b>DCG-125/22</b>	125mm	22mm	36
<b>DCG-150/19</b>	150mm	19mm	36
<b>DCG-180/22</b>	180mm	22mm	24



## MTC - Professional

- Surface grinding & finishing, universal / concrete, stock removal
- Turbo rim

Code	Diameter	Bore	
<b>MTC-100/15</b>	100mm	15mm	24
<b>MTC-100/22</b>	100mm	22mm	24



## V30 - Vacuum Brazed Blade

- Granite and marble
- With triangle electroplated design. For mounting directly on grinder

Code	Diameter	Bore	
<b>V30-230/M14</b>	230mm	M14	1

# WET & DRY CORES

## DCX - Professional Dry Core Drill

- Concrete, universal & building products



Code	Diameter	Length	Fitting	
DCX-032	32mm	150mm	1/2" BSP(F)	1
DCX-038	38mm	150mm	1/2" BSP(F)	1
DCX-065	65mm	150mm	1/2" BSP(F)	1
DCX-078	78mm	150mm	1/2" BSP(F)	1
DCX-091	91mm	150mm	1/2" BSP(F)	1
DCX-102	102mm	150mm	1/2" BSP(F)	1
DCX-107	107mm	150mm	1/2" BSP(F)	1
DCX-158	158mm	150mm	1/2" BSP(F)	1
DCX-162	162mm	150mm	1/2" BSP(F)	1
DCX-182	182mm	150mm	1/2" BSP(F)	1

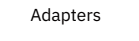

Adapters

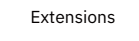

Extensions

## Accessories - Adapters

Code	Description	
AC-X03	Hex adapter pack (adapter, guide, drift)	1
AC-S03	SDS adapter pack (adapter, guide, drift)	1
AC-S01	SDS adapter only	1
AC-B05	Drift key	1
AC-B13	A taper drill	1

## Accessories - Extensions

Code	Description	
AC-B25	1/2" BSP 250mm Hollow	1
AC-B26	1/2" BSP 250mm (A-taper)	1
AC-X25	HEX 250mm EXT	1
AC-S25	SDS 250mm Long adapter	1

## XQ8 - BESPOKE LENGTH WET CORE DRILLS

BESPOKE WET CORE DRILLS FOR BOX DRILLING IN RESTRICTED SPACES

CALL US NOW TO SPECIFY YOUR REQUIRED LENGTH  
020 8311 1144



## XQ8 - Professional Wet cores

- With short barrels for use when drilling in restricted space
- Other sizes are available on request. Please specify your diameter & length

Code	Diameter	Lengths available from stock			
XQ8-N052	52mm	150mm	250mm	300mm	1
XQ8-N066	66mm	150mm	250mm	300mm	1
XQ8-N072	72mm	150mm	250mm	300mm	1
XQ8-N102	102mm	150mm	250mm	300mm	1
XQ8-N107	107mm	150mm	250mm	300mm	1



## XP5 - Professional Wet Core Drill

- Reinforced concrete (flint or limestone aggregate)
- 1¼" UNC female fitting (F), ½" BSP male fitting (M)



1¼" UNC Female Fitting



½" BSP Male Fitting

Code	Diameter	Length	Fitting	
XP5-S020	20mm	300mm	½" BSP (M)	1
XP5-S025	25mm	300mm	½" BSP (M)	1
XP5-S028	28mm	300mm	½" BSP (M)	1
XP5-S030	30mm	300mm	½" BSP (M)	1
XP5-S032	32mm	300mm	½" BSP (M)	1
XP5-S036	36mm	300mm	½" BSP (M)	1
XP5-S045	45mm	300mm	½" BSP (M)	1
XP5-S052	52mm	300mm	½" BSP (M)	1
XP5-N052	52mm	450mm	1¼" UNC (F)	1
XP5-N062	62mm	450mm	1¼" UNC (F)	1
XP5-N065	65mm	450mm	1¼" UNC (F)	1
XP5-N072	72mm	450mm	1¼" UNC (F)	1
XP5-N076	76mm	450mm	1¼" UNC (F)	1
XP5-N087	87mm	450mm	1¼" UNC (F)	1
XP5-N092	92mm	450mm	1¼" UNC (F)	1
XP5-N102	102mm	450mm	1¼" UNC (F)	1
XP5-N107	107mm	450mm	1¼" UNC (F)	1
XP5-N112	112mm	450mm	1¼" UNC (F)	1
XP5-N117	117mm	450mm	1¼" UNC (F)	1
XP5-N122	122mm	450mm	1¼" UNC (F)	1
XP5-N127	127mm	450mm	1¼" UNC (F)	1
XP5-N142	142mm	450mm	1¼" UNC (F)	1
XP5-N152	152mm	450mm	1¼" UNC (F)	1
XP5-N162	162mm	450mm	1¼" UNC (F)	1
XP5-N172	172mm	450mm	1¼" UNC (F)	1
XP5-N200	200mm	450mm	1¼" UNC (F)	1
XP5-N250	250mm	450mm	1¼" UNC (F)	1
XP5-N300	300mm	450mm	1¼" UNC (F)	1
XP5-N350	350mm	450mm	1¼" UNC (F)	1
XP5-N400	400mm	450mm	1¼" UNC (F)	1
XP5-N450	450mm	450mm	1¼" UNC (F)	1



## Wet Core Accessories

- Granite and marble
- With triangle electroplated design. For mounting directly on grinder

Code	Description	
AC-N20	1¼" UNC 200mm extension	1
AC-N30	1¼" UNC 300mm extension	1
AC-N55	½" BSP (M) ½" - BSP (M) Adapter	1
AC-N56	½" BSP (F) ½" - BSP (F) Adapter	1
AC-N65	½" BSP (M) - 1¼" UNC (M) Adapter	1
AC-N66	½" BSP (F) - 1¼" UNC (F) Adapter	1



# CUTTING & DRILLING



Abrasive Discs - Cutting & Grinding Discs	<b>40-41</b>
SDS Plus Masonry Drill Bits	<b>42</b>
SDS Max Masonry Drill Bits & Chisels	<b>43</b>
Auger Bits & Flat Bits	<b>44</b>
HSS Drill Bits & Spear Bits	<b>45</b>
Hole Saw & Arbors	<b>46</b>
Reciprocating Saw Blades	<b>47</b>
Multitool Blades	<b>48-49</b>
Circular Saw & Jigsaw Blades	<b>50</b>

## ABRASIVE DISCS - CUTTING &amp; GRINDING DISCS

BEST  
SELLER

## Flat Disc

- Metal cutting

Code	Dimensions (mm)	
M-FLC-100/16	100 x 3 x 16	25
M-FLC-115/22	115 x 3 x 22.2	25
M-FLC-125/22	125 x 3 x 22.2	25
M-FLC-230/22	230 x 3 x 22.2	25
M-FLC-300/20	300 x 3.5 x 20	25
M-FLC-300/22	300 x 3.5 x 22.2	25
M-FLC-350/25	350 x 3.5 x 25.4	25

## Premium Flat Disc - Phoenix 300

- Metal cutting



Code	Dimensions (mm)	
M-FLC-300/20P	300 x 3.5 x 20	25

## Thin Disc

- Metal slitting



Code	Dimensions (mm)	
M-SLT-115/22	115 x 1 x 22.2	25
M-SLT-125/22	125 x 1 x 22.2	25
M-SLT-230/22	230 x 1.9 x 22.2	25

## Depressed Centre Disc

- Metal Grinding



Code	Dimensions (mm)	
<b>M-GRD-100/16</b>	100 x 6 x 16	25
<b>M-GRD-115/22</b>	115 x 6 x 22.2	25
<b>M-GRD-125/22</b>	125 x 6 x 22.2	25
<b>M-GRD-230/22</b>	230 x 6 x 22.2	25

**BEST  
SELLER**

## Flat Disc

- Stone Cutting



Code	Dimensions (mm)	
<b>S-FLC-100/16</b>	100 x 3 x 16	25
<b>S-FLC-115/22</b>	115 x 3 x 22.2	25
<b>S-FLC-125/22</b>	125 x 3 x 22.2	25
<b>S-FLC-230/22</b>	230 x 3 x 22.2	25
<b>S-FLC-300/20</b>	300 x 3.5 x 20	25
<b>S-FLC-300/22</b>	300 x 3.5 x 22.2	25

## Depressed Centre Disc

- Stone Grinding



Code	Dimensions (mm)	
<b>S-GRD-100/16</b>	100 x 6 x 16	25
<b>S-GRD-115/22</b>	115 x 6 x 22.2	25
<b>S-GRD-125/22</b>	125 x 6 x 22.2	25
<b>S-GRD-230/22</b>	230 x 6 x 22.2	25

## SDS PLUS MASONRY DRILL BITS

The list below is only a selection of very common sizes. We have a full range of sizes available so if you require any sizes not shown please call our sales team on 020 8311 1144

Code	Diameter	Total length	Working length	
SDSP-5/160	5mm	160mm	100mm	10
SDSP-5.5/160	5.5mm	160mm	100mm	10
SDSP-5.5/210	5.5mm	210mm	150mm	10
SDSP-6/160	6mm	160mm	100mm	10
SDSP-6.5/160	6.5mm	160mm	100mm	10
SDSP-6/210	6mm	210mm	150mm	10
SDSP-6.5/210	6.5mm	210mm	150mm	10
SDSP-7/160	7mm	160mm	100mm	10
SDSP-7/210	7mm	210mm	150mm	10
SDSP-8/160	8mm	160mm	100mm	10
SDSP-8/210	8mm	210mm	100mm	10
SDSP-8/260	8mm	260mm	200mm	10
SDSP-9/210	9mm	210mm	150mm	10
SDSP-10/160	10mm	160mm	100mm	10
SDSP-10/260	10mm	260mm	200mm	10
SDSP-10/460	10mm	460mm	400mm	10
SDSP-10/600	10mm	600mm	550mm	10
SDSP-12/310	12mm	310mm	150mm	10
SDSP-12/450	12mm	450mm	400mm	10
SDSP-12/1000	12mm	1000mm	950mm	10
SDSP-13/300	13mm	300mm	250mm	10
SDSP-13/450	13mm	450mm	250mm	10
SDSP-14/160	14mm	160mm	100mm	10
SDSP-14/210	14mm	210mm	100mm	10
SDSP-14/310	14mm	310mm	250mm	10
SDSP-14/450	14mm	450mm	250mm	10
SDSP-14/600	14mm	600mm	550mm	10
SDSP-15/250	15mm	250mm	200mm	10
SDSP-16/160	16mm	160mm	200mm	10
SDSP-16/300	16mm	300mm	250mm	10
SDSP-16/450	16mm	450mm	400mm	10
SDSP-16/600	16mm	600mm	550mm	10
SDSP-18/300	18mm	300mm	250mm	10
SDSP-18/450	18mm	450mm	400mm	10
SDSP-18/1000	18mm	1000mm	950mm	10
SDSP-20/300	20mm	300mm	250mm	10
SDSP-20/450	20mm	450mm	400mm	10
SDSP-22/300	22mm	300mm	240mm	10
SDSP-22/600	22mm	600mm	550mm	10
SDSP-24/450	24mm	450mm	400mm	10
SDSP-25/300	25mm	300mm	400mm	10
SDSP-25/450	25mm	450mm	400mm	10
SDSP-25/1000	25mm	1000mm	950mm	10
SDSP-26/450	26mm	450mm	400mm	10
SDSP-28/450	28mm	450mm	400mm	10
SDSP-30/450	30mm	450mm	400mm	10



## Blow Out Pump Hole Cleaner

- Ideal for cleaning dust from drilled holes prior to applying bonded anchors for installing mechanical anchors
- Hole cleaning is necessary for correct loads
- Manual, easy to use
- Serial application
- Approved for use in:
  - Cracked concrete
  - Non-cracked concrete C20/25-C50/60
  - Aerated concrete block
  - Hollow Sand-lime brick
  - Solid Sand-lime brick
  - Hollow brick
  - Hollow lightweight concrete block



Code

BOP01



1

## SDS MAX Drill bits



Code	Diameter	Total length	Working length	
<b>SDSM-12/340</b>	12mm	340mm	200mm	10
<b>SDSM-12/540</b>	12mm	540mm	400mm	10
<b>SDSM-14/340</b>	14mm	340mm	200mm	10
<b>SDSM-14/540</b>	14mm	540mm	400mm	10
<b>SDSM-16/340</b>	16mm	340mm	200mm	10
<b>SDSM-16/540</b>	16mm	540mm	400mm	10
<b>SDSM-18/340</b>	18mm	340mm	200mm	10
<b>SDSM-18/540</b>	18mm	540mm	400mm	10
<b>SDSM-20/320</b>	20mm	320mm	200mm	10
<b>SDSM-20/520</b>	20mm	520mm	400mm	10
<b>SDSM-20/920</b>	20mm	920mm	800mm	10
<b>SDSM-22/320</b>	22mm	320mm	200mm	10
<b>SDSM-22/520</b>	22mm	520mm	400mm	10
<b>SDSM-24/520</b>	24mm	520mm	400mm	10
<b>SDSM-25/320</b>	25mm	320mm	200mm	10
<b>SDSM-25/520</b>	25mm	520mm	400mm	10
<b>SDSM-25/920</b>	25mm	920mm	800mm	10
<b>SDSM-26/520</b>	26mm	520mm	400mm	10
<b>SDSM-28/520</b>	28mm	520mm	400mm	10
<b>SDSM-30/520</b>	30mm	520mm	400mm	10
<b>SDSM-32/520</b>	32mm	520mm	400mm	10
<b>SDSM-35/520</b>	35mm	520mm	400mm	10
<b>SDSM-38/520</b>	38mm	520mm	400mm	10
<b>SDSM-40/520</b>	40mm	520mm	400mm	10

## SDS Plus & SDS Max Points & Chisels



Flat Chisel



Pointed Chisel

Code	Diameter	Total length	Working length	Fitting	
<b>SDSP-20/250P</b>	20mm	250mm	200mm	SDS Plus - Point	10
<b>SDSM-20/400P</b>	20mm	400mm	350mm	SDS Max-Point	10
<b>SDSP-20/250FC</b>	20mm	250mm	200mm	SDS Plus-Flat Chisel	10
<b>SDSP-20/250SC</b>	20mm	250mm	200mm	SDS Plus-Spade Chisel	10
<b>SDSP-40/250FC</b>	40mm	250mm	200mm	SDS Plus-Flat Chisel	10
<b>SDSM-20/280P</b>	20mm	280mm	220mm	SDS Max-Point	10
<b>SDSM-25/280FC</b>	25mm	280mm	220mm	SDS Max-Flat Chisel	10
<b>SDSM-25/400FC</b>	25mm	400mm	350mm	SDS Max-Flat Chisel	10
<b>SDSM-50/300SC</b>	50mm	300mm	350mm	SDS Max-Spade Chisel	10
<b>SDSM-80/300SC</b>	80mm	300mm	250mm	SDS Max-Spade Chisel	10



## FOR MASONRY & STEEL FIXINGS

SEE PAGE 394



## AUGER BITS &amp; FLAT BITS

## Hex Shank

Code	Diameter	Total length	Working length	
DBAHEX-06/235	6mm	235mm	160mm	1
DBAHEX-08/235	8mm	235mm	160mm	1
DBAHEX-10/235	10mm	235mm	160mm	1
DBAHEX-10/450	10mm	450mm	400mm	1
DBAHEX-12/235	12mm	235mm	160mm	1
DBAHEX-14/235	14mm	235mm	160mm	1
DBAHEX-16/460	16mm	460mm	400mm	1
DBAHEX-18/235	18mm	235mm	160mm	1
DBAHEX-18/460	18mm	460mm	400mm	1
DBAHEX-20/235	20mm	235mm	160mm	1
DBAHEX-22/235	22mm	235mm	160mm	1
DBAHEX-22/450	22mm	450mm	400mm	1
DBAHEX-24/235	24mm	235mm	160mm	1
DBAHEX-25/235	25mm	235mm	160mm	1
DBAHEX-26/460	26mm	460mm	400mm	1
DBAHEX-28/235	28mm	235mm	160mm	1
DBAHEX-30/235	30mm	235mm	160mm	1
DBAHEX-32/235	32mm	235mm	160mm	1



## SDS Plus Shank



Code	Diameter	Total length	Working length	
DBASDS06/235	6mm	235mm	160mm	1
DBASDS08/235	8mm	235mm	160mm	1
DBASDS10/235	10mm	235mm	160mm	1
DBASDS12/235	12mm	235mm	160mm	1
DBASDS14/235	14mm	235mm	160mm	1
DBASDS16/235	16mm	235mm	160mm	1
DBASDS19/235	19mm	235mm	160mm	1
DBASDS20/235	20mm	235mm	160mm	1
DBASDS22/235	22mm	235mm	160mm	1
DBASDS25/235	25mm	235mm	160mm	1

## Flat Bits Hex Shank

• Total length 152mm

• Working length 50mm

Code	Diameter	
DBFT6	6mm	1
DBFT8	8mm	1
DBFT10	10mm	1
DBFT12	12mm	1
DBFT13	13mm	1
DBFT14	14mm	1
DBFT16	16mm	1
DBFT18	18mm	1
DBFT19	19mm	1
DBFT20	20mm	1
DBFT22	22mm	1
DBFT24	24mm	1
DBFT25	25mm	1
DBFT28	28mm	1
DBFT30	30mm	1
DBFT32	32mm	1
DBFT34	34mm	1
DBFT35	35mm	1
DBFT36	36mm	1
DBFT38	38mm	1
DBFT40	40mm	1



## HSS Roll Forged Jobber

- Straight shank
- High speed drill
- Big, robust core thickness
- High elasticity
- For steel, cast iron, aluminium, malleable cast, copper, brass, iron & hard plastics



Code	Diameter	Total length	Flute length	
DBH2	2mm	49mm	24mm	10
DBH3	3mm	61mm	33mm	10
DBH4	4mm	75mm	43mm	10
DBH5	5mm	86mm	52mm	10
DBH6	6mm	93mm	57mm	10
DBH7	7mm	101mm	69mm	10
DBH8	8mm	117mm	75mm	10
DBH9	9mm	125mm	81mm	10
DBH10	10mm	133mm	87mm	10
DBH11	11mm	142mm	94mm	10
DBH12	12mm	151mm	101mm	10
DBH14	14mm	160mm	108mm	10

## HSS Drill Bit Sets



Code	Diameter	
BHSSSET25	25 Drill bit set from 1-13mm in 0.5mm increments	1

## Hex Spear Bit Drills for Tile, Stone & Glass

- Length 50mm
- Hard stone, tiles (inc. porcelain) & glass
- Fast drilling
- Clean finish
- No pilot required



Code	Diameter	
DBSP6	6mm	1
DBSP8	8mm	1

## FIXINGS & FASTENERS

FOR OUR RANGE OF  
FIXINGS & FASTENERS  
GO TO PAGES  
383-400



# HOLE SAWS & ARBORS

## Bi-Metal Hole Saws

- Features a smooth and fast cutting action
- Aggressive material penetration and swarf clearance
- 38mm cutting depth
- Will cut thin and thick gauge materials
- Suitable for cutting steel, aluminium, sheet metal, metal/mild metal, non-ferrous metals, cast iron, hard/soft wood and PVC



Code	Diameter	
BMHS-14	14mm	1
BMHS-16	16mm	1
BMHS-17	17mm	1
BMHS-19	19mm	1
BMHS-20	20mm	1
BMHS-21	21mm	1
BMHS-22	22mm	1
BMHS-24	24mm	1
BMHS-25	25mm	1
BMHS-27	27mm	1
BMHS-29	29mm	1
BMHS-30	30mm	1
BMHS-32	32mm	1
BMHS-33	33mm	1
BMHS-35	35mm	1
BMHS-38	38mm	1
BMHS-40	40mm	1
BMHS-41	41mm	1
BMHS-43	43mm	1
BMHS-44	44mm	1
BMHS-46	46mm	1
BMHS-48	48mm	1
BMHS-51	51mm	1
BMHS-52	52mm	1

Code	Diameter	
BMHS-54	54mm	1
BMHS-55	55mm	1
BMHS-57	57mm	1
BMHS-60	60mm	1
BMHS-64	64mm	1
BMHS-67	67mm	1
BMHS-68	68mm	1
BMHS-70	70mm	1
BMHS-73	73mm	1
BMHS-76	76mm	1
BMHS-79	79mm	1
BMHS-83	83mm	1
BMHS-86	86mm	1
BMHS-89	89mm	1
BMHS-92	92mm	1
BMHS-95	95mm	1
BMHS-98	98mm	1
BMHS-102	102mm	1
BMHS-105	105mm	1
BMHS-108	108mm	1
BMHS-111	111mm	1
BMHS-114	114mm	1
BMHS-121	121mm	1

## Arbors



Code	To Suit	
ARB1430	14mm - 30mm	1
ARB32152	32mm - 152mm	1



## Reciprocating Saw Blades



Code	Material	Product Ref:	Length	TPI	Cut Type	Pack Size	
RECIPB-230	Metal	N/A	230mm(9")	14	Metal / Reinforced / Multi	5	1
RECIPB-300	Metal	N/A	300mm(12")	14	Metal / Steel	5	1
RECIPW-300	Wood	N/A	300mm(12")	6	Softwood / Fast cut	5	1
RECIP966R	Demolition	966R	230mm(9")	6	Fast cutting	5	1
RECIP610R	Metal	610R	150mm(6")	10	Fast cutting	5	1
RECIP614R	Metal	614R	150mm(6")	14	Fine cutting	5	1
RECIP618R	Metal	618R	150mm(6")	18	Very fine cutting	5	1
RECIP624R	Metal	624R	150mm(6")	24	Fine cutting	5	1
RECIP818R	Metal	818R	200mm(8")	18	Very fine cutting	5	1
RECIP110R	Wood/Metal	110R	300mm(12")	14	Fast cutting	5	1

ORDER 6AM TO 7PM FOR NEXT MORNING DELIVERY

Set up an account for our discounted rates / prices

## MULTITOOL BLADES

## Bi-Metal Multitool Blades

- Bi-metal blade for cutting wood, wood with nails & non ferrous metals
- Universal cutting up to 42mm deep
- Available in packs of 10



Code



<b>MT32BM10</b>	32mm Bi-Metal Sawblade - Pack of 10	5
<b>MT44BM10</b>	44mm Bi-Metal Sawblade - Pack of 10	5

5

5

## Fast Cutting Wood Multitool Blades

- Fast cutting blade for wood, timber overlay flooring & plastics etc.
- Universal cutting up to 42mm deep
- The large tooth style allow a fast cut in most timber, laminate and plastic applications
- Available in packs of 10

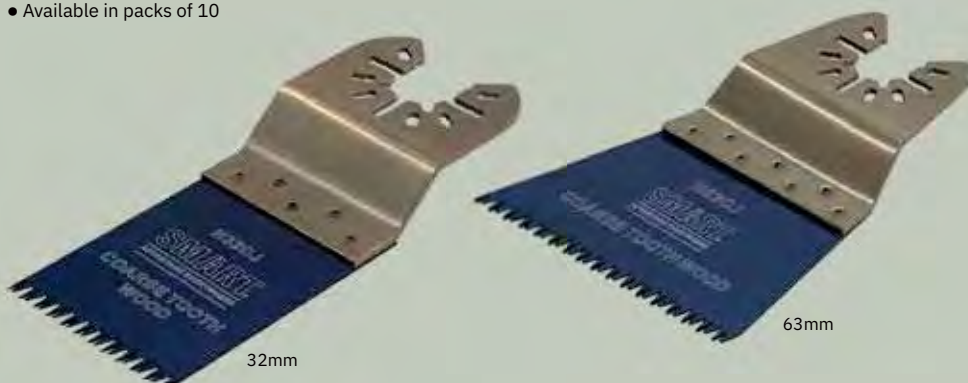

Code



<b>MT32CJ10</b>	32mm Fast Cutting Sawblade - Pack of 10	5
<b>MT63CJ10</b>	63mm Fast Cutting Sawblade - Pack of 10	5

5

5

### Fine Tooth Wood Multitool Blades

- Fine tooth timber cutting blade, ideal for general purpose timber cutting
- The Fine tooth wood blades are a firm favourite for detailed cutting in timber
- The smaller tooth design still gives a fast cut, but a neater finish, and a very controlled cut when precision is needed
- Available in packs of 10

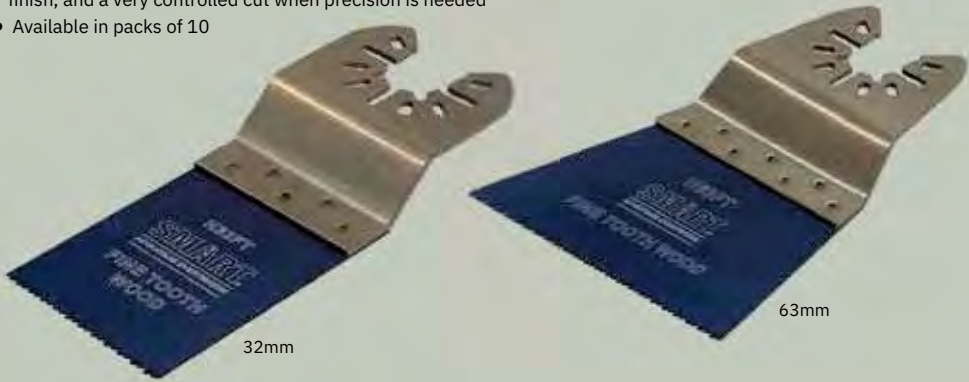

Code



<b>MT32FT10</b>	32mm Fine Tooth Sawblade - Pack of 10	5
<b>MT63FT10</b>	63mm Fine Tooth Sawblade - Pack of 10	5

## POWER TOOLS

FOR OUR RANGE OF  
POWER TOOLS  
GO TO PAGES  
414-415

HAVE  
YOU  
SEEN?



ORDER 6AM TO 7PM FOR NEXT MORNING DELIVERY

Set up an account for our discounted rates / prices

## CIRCULAR SAW &amp; JIGSAW BLADES

## TCT Circular Saw Blades

- For cutting wood

**MAX**  
QUALITY  
UNMATCHED.

**BEST  
SELLER**



Code	Diameter	Bore	No. of teeth	
TCT-160/20/24	160mm	20mm	24	25
TCT-160/20/48	160mm	20mm	48	25
TCT-165/20/24	165mm	20mm	24	25
TCT-185/30/28	185mm	30mm	28	25
TCT-235/30/28	235mm	30mm	28	25
TCT-235/30/40	235mm	30mm	40	25
TCT-235/30/60	235mm	30mm	60	25

## Jigsaw Blades

- 5 blades per card



Code	Material	Type	TPI	Total length	Working length	
JB10	Wood	Chrome Vanadium	8	100mm	75mm	1
T127D	Metal	HSS	8	100mm	75mm	1
T101D	Wood	Chrome Vanadium	6	100mm	75mm	1
T118A	Metal	HSS	21	75mm	50mm	1
T101B	Wood	Chrome Vanadium	13	100mm	75mm	1

# GROUNDWORK TOOLS



All Steel Tools	54-56
Ash Handled Tools	57
Polyfibre Tools	58-59
Richard Carter Polyfibre Tools	60
Insulated Tools	61-63
Richard Carter Insulated	64-65
Crowbars & Pickaxes	66
Pickaxes & Mattocks	67
Rakes	68
Lutes, Squeegees & Concrete Placers	69
Wheelbarrows & Trucks	70-73
Brooms & Handles	74-75
Mauls, Mallets, Kerb Lifters & Sledge Hammers	76
Buckets	77
Mortar Tubs & Watering Cans	78
Dust Suppression Bottles	79-80
Water containers	80
Sprayers	81-82
Winter Essentials	83-84

# ALL STEEL TOOLS

Our best-selling range of tubular steel shafted solid socket shovels are designed for the heavier usage involved on building sites. We rotary weld our contoured steel handles into the body of the shovel socket for extra strength and rigidity - thus producing a very robust yet lightweight tool for digging.



SHSQS



SHTMS



SHRMS



SHTRS



SHCLS



CS02G



SHNDS



SHDS01

# ASH HANDLED TOOLS

Most wooden shafted tools are available with 'T' or galvanised steel, heavy duty 'MYD' grips. We only use best quality, specially selected slow growing, straight grained hardwoods. The 'flower' of the grain is on the side of the handle for greater strength and flexibility - the strong, straight grain running from front to back. The MYD is ergonomically designed to comfortably fit the largest of hands.



SHSQWH



SHTMWH



SHTRWH



SHCLWH



FKCW01

# INSULATED TOOLS

We provide a comprehensive range of insulated tools to suit all your needs, whether it's shovelling out, breaking ground, laying pipes or backfilling trenches. Each tool is individually flash tested to 10,000V and fully compliant to pass BS8020: 2011. With over 150 cable strikes reported a day, our insulated tools are essential to keep your workers safe in risk areas.



SHSQI



SHTMI



SHTRI



SHCLI



SHCGI



SHNDI



SHDSI

# POLYFIBRE TOOLS

Our PolyFibre range of solid forged Contractors Tools will not rot, shrink, dry out or become more susceptible to breakage through periods of inactivity. They offer the worker a high degree of fibreglass strength along with the comfort of a profile moulded PYD hand grip. Injection moulded polypropylene sheathing totally encloses the polyester resin fibreglass core ensuring reliability and virtually eliminating the danger of handle breakage and potential injury.



SHSQFG



SHTMFG



SHSRFG



SHTRFG



SHCLFG



SHCGFG



SHNDFG



SHFKFG

**ALL STEEL TOOLS - SHOVELS**

**Square Mouth**

- Blade size: 10 x 12½"

**BEST SELLER**



Code



**SHSQS**

5

**Taper Mouth**

- Blade size: 10 to 8½ x 12½"

**BEST SELLER**



Code



**SHTMS**

5

**Round Mouth**

- Blade size: 10 x 12½"
- WSL



Code



**SHRMS**

5

**GPO Trenching**

- Blade size: 7 x 11"



Code



**SHTRS**

5

**Cable Layer (1-Way)**

- Blade size: 5½ to 4½ x 11"



Code



**SHCLS**

5

**Clay Grafter**

- Blade size: 6 x 12"



Code



**CS02G**

5



**Contractors Fork**

- Fork size: 8 x 12"



Code



FKCS01

5

**Newcastle Draining Tool**

- Blade size: 7 to 4 x 12½"
- 16"



Code



SHNDS

5

**Treaded Digging Spade**

- Blade size: 7½ x 11½"



Code



SHDS01

5

**GPO Post Hole Spade**

- Tubular steel
- Blade size: 12 x 5½"



Code



SHRSS54

5

**Heavy Duty Shov-Holer**

- Blade size: 7½ x 11½"



Code



SHSHS

5

**ALL STEEL TOOLS - CROWBARS, PUNNERS, & RAKES**

**Chisel & Point Crowbar - All steel**

- 60" overall length
- High-grade heat-treated steel bar
- Pinch point end for easy penetration.
- Ideal for levering heavy objects,

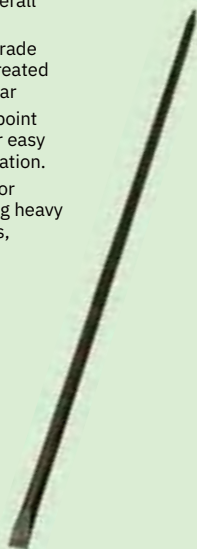

Code



**CRCPR1500**

1

**10lb Square Rammer**

- 48" tubular steel
- Head size: 5¼ x 5¼"



Code



**PN10**

5

**22lb Rectangle Rammer**

- 48" tubular steel
- Head size: 8 x 5"



Code



**PN22**

5

**16T Round Tooth Tarmac Rake**

- 66" tubular steel
- Head size: 16 x 4"



Code



**RKTRTS**

5

**16T Round Tooth Asphalt Rake**

- 66" tubular steel
- Head size: 16 x 4"



Code



**RKASTS**

5

**NEED BS8020 INSULATED TOOLS?**

SEE PAGES 61-65



ASH HANDLED TOOLS & GULLEY BOWL

Square Mouth

- Blade size: 10 x 12½"



Code

SHSQWH



5

Taper Mouth

- Blade size: 10" to 8½ x 12½"



Code

SHTMWH



5

GPO Trenching (2-Way)

- Blade size: 7 x 11"



Code

SHTRWH



5

Contractors Fork

- Fork size: 8 x 12"



Code

FKCW01



5

Cable Layer (1-Way)

- Blade size: 5½ to 4½ x 11"



Code

SHCLWH



5

Heavy Duty Shov-Holer

- 48" hardwood Plain handle
- Head size: 8 x 26"



Code

SHSHWH



1

Gully Bowl

- 72" handle
- Bowl size: 6" dia.



Code

BOXSC06



1

16T Round Tooth Tarmac Rake

- 48" hardwood Plain handle
- Head size: 16 x 4"



Code

RKTRTW



5

16T Square Tooth Asphalt Rake

- 48" hardwood Plain handle
- Head size: 16 x 4"



Code

RKASTW



5

POLYFIBRE TOOLS - SHOVELS & GRAFTERS

Square Mouth

- Blade size: 10 x 12½"



Code



SHSQFG

5

Taper Mouth

- Blade size: 10 x 12½"



Code



SHTMFG

5

Round Mouth

- Blade size: 10 x 12½"



Code



SHSRFG

5

GPO Trenching (2-Way)

- Blade size: 7 x 11"



Code



SHTRFG

5

Cable Layer (1-Way)

- Blade size: 5½ to 4½ x 11"



Code



SHCLFG

5

Clay Grafter

- Blade size: 6 x 12"



Code



SHCGFG

5

Newcastle Draining Tool

- Blade size: 7 to 4 x 16"



Code

SHNDFG



5

Treaded Spade

- Blade size: 7½ x 11½"



Code

SHDSFG



5

Contractors Fork

- Blade size: 8 x 12"



Code

SHFKFG



1

Crow Bar - Fibreglass Chisel & Point

- 60" overall length
- 31.8mm diameter
- Fibreglass shaft



Code

CRCPFG500



5

HAVE YOU SEEN?

THE ALL NEW MAXBARROW

BEST SELLER

SEE PAGE 70



MAXBARROW

**RICHARD CARTERS - POLYFIBRE PRO RANGE**

**No.2 Square Mouth Shovel**

- Blade size: 10 x 12½"



Code

**SHSQFGRC**



5

**No.2 Taper Mouth Shovel**

- Blade size: 10 x 12½"



Code

**SHTMFGRC**



5

**Clay Grafter**

- Blade size: 6 x 12"



Code

**SHCGFGRC**



5

**No.0 GPO Trencher (2-Way)**

- Blade size: 7 x 11"



Code

**SHTRFGRC**



5

**Cable Layer (1-Way)**

- Blade size: 5½ to 4½ x 11"



Code

**SHCLFGRC**



5

**Newcastle Draining Tool**

- Blade size: 7 to 4 x 16"



Code

**SHNDFGRC**



5

# STRIKESAFE

COMPLIANT TO BS8020: 2011

Excess of £2m fine for an arc incident

Each tool has its own serial number and certificate

Each tool individually flash tested to 10,000V



150 - 180 cable strikes are reported a day

50% of service maps (cable routes) are incorrect

INDEPENDENTLY TESTED

AND CERTIFIED IN THE UK

INSULATED TOOLS - SHOVELS & GRAFTERS

**No.2 Square Mouth**

- Blade size: 10 x 12½"
- Conforms to BS8020: 2011
- Flash tested to 10,000V

**STR/KESAFE**



Code



**SHSQI**

5

**No.2 Taper Mouth**

- Blade size: 10 to 8½ x 12½"
- Conforms to BS8020: 2011
- Flash tested to 10,000V

**STR/KESAFE**



Code



**SHTMI**

5

**Newcastle Draining Tool**

- Blade size: 7 to 4 x 16"
- Conforms to BS8020: 2011
- Flash tested to 10,000V

**STR/KESAFE**



Code



**SHNDI**

5

**Clay Grafter**

- Blade size: 6 x 12"
- Conforms to BS8020: 2011
- Flash tested to 10,000V

**STR/KESAFE**



Code



**SHCGI**

5



## GPO Post Hole Spade

- Blade size: 5½ x 12"
- 54" or 78"
- Conforms to BS8020: 2011
- Flash tested to 10,000V

**STR/KESAFE**



Code



**SHRSI54** 54"

1

**SHRSI78** 78"

1

## Heavy Duty Shov-Holer

- Blade size: 8 x 26"
- Scissor action
- Conforms to BS8020: 2011
- Flash tested to 10,000V

**STR/KESAFE**



Code



**SHSHI48** 48"

1

**SHSHI54** 54"

1

**SHSHI78** 78"

1

## Cable Layer (1 Way)

- Blade size: 5 to 4½ x 11"
- Conforms to BS8020: 2011
- Flash tested to 10,000V

**STR/KESAFE**



Code



**SHCLI**

5

## Treaded Spade

- Blade size: 7½ x 11½"
- Conforms to BS8020: 2011
- Flash tested to 10,000V

**STR/KESAFE**



Code



**SHDSI**

5

## Heavy Contractors Fork

- Fork size: 8 x 12"
- Conforms to BS8020: 2011
- Flash tested to 10,000V

**STR/KESAFE**



Code



**SHFKFI**

5

## No.0 GPO Trencher (2-Way)

- Blade size: 7 x 11"
- Conforms to BS8020: 2011
- Flash tested to 10,000V

**STR/KESAFE**



Code



**SHTRI**

5

RICHARD CARTERS - SHOCKSAFE SHOVELS & GRAFTERS

**No.2 Square Mouth**

- Blade size: 10 x 12½"
- Conforms to BS8020: 2011
- Flash tested to 10,000V



Code



SHSQIRC

5

**No.2 Taper Mouth**

- Blade size: 10 to 8½ x 12½"
- Conforms to BS8020: 2011
- Flash tested to 10,000V



Code



SHTMIRC

5

**Clay Grafter**

- Blade size: 6 x 12"
- Conforms to BS8020: 2011
- Flash tested to 10,000V



Code



SHCGIRC

5

**No.0 GPO Trencher (2-Way)**

- Blade size: 7 x 11"
- Conforms to BS8020: 2011
- Flash tested to 10,000V



Code



SHTRIRC

5

**Cable Layer (1-Way)**

- Blade size: 5 to 4½ x 11"
- Conforms to BS8020: 2011
- Flash tested to 10,000V



Code



SHCLIRC

5

**Newcastle Draining Tool**

- Blade size: 7 to 4 x 16"
- Conforms to BS8020: 2011
- Flash tested to 10,000V



Code



SHNDIRC

5

## Heavy Contractors Fork

- Fork size: 8 x 12"
- Conforms to BS8020: 2011
- Flash tested to 10,000V



Code



**SHFKFIRC**

5

## Treaded Spade

- Blade size: 7½ x 11½"
- Conforms to BS8020: 2011
- Flash tested to 10,000V



Code



**SHDSIRC**

5

## 10lb Punner

- 10lb
- Conforms to BS8020: 2011
- Flash tested to 10,000V



Code



**PN10INS**

1

## SUMO Digging Bar Chisel & Point

- 35mm Dia. shaft
- 60" Overall
- Double end
- Conforms to BS8020: 2011
- Flash tested to 10,000V



Code



**SUMOINS**

1

## SUMO Post Hole Spade

- Blade size: 5½ x 12"
- 32mm Dia. shaft
- 54" Overall
- Conforms to BS8020: 2011
- Flash tested to 10,000V



Code



**SUMOFGI54**

1

## King SUMO Post Hole Spade

- Blade size: 5½ x 12"
- 35mm Dia. shaft
- 54" Overall
- Conforms to BS8020: 2011
- Flash tested to 10,000V

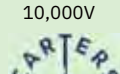

Code



**SUMOPHS54**

1

CROWBARS & PICKAXES

Chisel & Point Crow Bar - Insulated

- 60" overall
- Insulated
- Conforms to BS8020: 2011
- Flash tested to 10,000V



Code

CRCPFI500



1

Chisel & Point Crow Bar - All Steel

- 60" overall length
- High-grade heat-treated steel bar
- Pinch point end for easy penetration.
- Ideal for levering heavy objects, wrecking work and digging

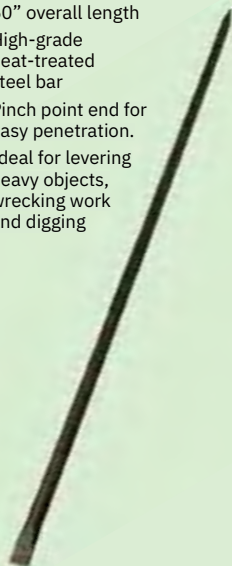

Code

CRCPR1500



1

Chisel & Point Crow Bar - Fibreglass

- 60" overall length
- 31.8mm diameter
- Fibreglass shaft



Code

CRCPG500



1

Insulated Pickaxe C/W Handle

- 7lb
- Conforms to BS8020: 2011
- Flash tested to 10,000V



Code

PXI007



5

Fully Insulated Pick Handle

- 36" fibreglass fully insulated with non-slip design
- Eye size 3" x 2"
- Conforms to BS8020: 2011



Code

PAX900



5

Hickory Pick Handle

- 36" straight grained hickory with clear varnished finish
- Eye size 3" x 2"



Code

PAHH900



5

**Fibreglass Pick Handle**

- 36" very strong fibreglass with non-slip design
- Eye size 3" x 2"



Code



PAHF900

5

**Hardwood Pick Handle**

- 36" straight grained hardwood with waxed finish
- Eye size 3" x 2"



Code



PAH900

5

**Demolition Head**

- 5lb
- Horizontal chisel and pick ends
- Suits all 36" handles
- Head only

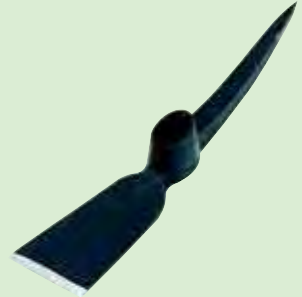

Code



MTD005

5

**Grubbing Head**

- 5lb
- Horizontal and vertical chisel ends
- Suits all 36" handles
- Head only



Code



MTG005

5

**Pick Head**

- 7lb
- Chisel end and point end
- Suits all 36" handles
- Head only



Code



PA007

5

**Mattock Demolition Head**

- 7lb
- Vertical chisel and grubbing ends
- Suits all 36" handles
- Head only



Code



MTD7LB

5

RAKES

Round Tooth Tarmac Rake

- Head size: 16 x 4"
- 16 Tooth
- Wooden handle



Code  **RKTRTW** 5

Round Tooth Tarmac Rake - Steel

- Head size: 16 x 4"
- 16 Tooth
- All steel



Code  **RKTRTS** 5

Square Tooth Asphalt Rake

- Head size: 16 x 4"
- 16 Tooth
- Wooden handle



Code  **RKASTW** 5

Square Tooth Asphalt Rake - Steel

- Head size: 16 x 4"
- 16 tooth
- All steel



Code  **RKASTS** 5

Plastic Rake

- 16 tyne



Code  **16PREP** 5

Lawn Rake



Code  **RKL01** 5

## Rubber Squeegee c/w Handle

- 24" wide



Code



**RKRS01**

5

## Tarmac Lute c/w Handle & Stay

- 24" wide



Code



**RKTL01**

5

## Premium Aluminium Spazzle

- 60" hardwood handle
- Blade size: 24 x 4"
- Aluminium blade



Code



**CA150**

5

## Heavy Duty Concrete Placer

- 60" hardwood handle
- Blade size: 20 x 4"
- Double dipped interchangeable aluminium blade



Code



**CA160**

5

# MAXBARROW



- New & improved design
- Strong, rigid one piece 32mm tubular frame
- 100 Litre heavy duty galvanised pan with rolled edge
- Non-slip comfort plus grip handle
- Height adjustable tipping point, to clear every kerb!
- Wider legs for greater stability. Wide supports ensure zero tip rating
- Leg support brace for extreme endurance
- Locking wheel nuts



**100 litre  
Ultra Heavy  
Duty Pan**



METAL WHEEL WITH BEARING FOR EASE OF PUSHING



NEW COMFORT GRIP HANDLE

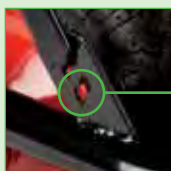

ADJUSTABLE TIPPING POINT

FRAME SECURED WITH LOCK NUTS



WIDER LEGS FOR GREATER STABILITY

Code

MAXBARROW	MAXBarrow with pneumatic tyre	1
MAXBARROW-SW	MAXBarrow with puncture-proof tyre	1





### Heavy Duty Galvanised 90 Litre Wheelbarrow

**BEST SELLER**

FROM ONLY **29.21**

HEAVY DUTY GALVANISED PAN

SUPERGRIP HANDLES

FRAME SECURED WITH LOCK NUTS

HIGHLY ROBUST SUPPORTS

METAL WHEEL WITH BEARING FOR EASE OF PUSHING



Code



<b>WB90LGALV</b>	Wheelbarrow with pneumatic tyre	1
<b>WB90LSW</b>	Wheelbarrow with puncture-proof tyre	1

### Steel 120 Litre Wheelbarrow

- 120 Litre heavy duty press pan
- Galvanised
- Pneumatic tyre
- Extra strong double rolled edge pan



Code



<b>WB120L</b>	With pneumatic tyre	1
<b>WB120LSW</b>	With puncture-proof tyre	1

### Belle Warrior 100 Litre Wheelbarrow

- Indestructible HDPE tray
- Non stick, easy to clean



Code



<b>BELLE02204</b>	With pneumatic tyre	1
-------------------	---------------------	---

ORDER **6AM TO 7PM** FOR NEXT MORNING DELIVERY

Set up an account for our discounted rates / prices

## WHEELBARROWS

### Haemmerlin Heavy Duty Steel 90 Litre Wheelbarrow

- 90 litre heavy duty press pan
- Lock nuts to pan
- Extra strong double rolled edge pan



WB90HAE



WBVANG

Code



<b>WB90HAE</b>	Haemmerlin with pneumatic tyre	1
<b>WBVANG</b>	Haemmerlin with puncture-proof tyre	1

### Replacement Pneumatic Wheel Kit

Suitable for:

- WB90LGALV
- WB120L
- MAXBARROW



Code



<b>WBRKIT</b>	1
---------------	---

### Puncture-Proof Wheel Kit

- Feels like a pneumatic tyre for comfortable use

Suitable for:

- WB90LGALV
- WB120L
- MAXBARROW



Code



<b>WB90KITGALV</b>	1
--------------------	---

### Haemmerlin Puncture-Proof Wheel Kit

Suitable for:

- WB90HAE



Code



<b>WBVANWKIT</b>	1
------------------	---

### Replacement Solid Wheel

Suitable for:

- WB85LE
- WB90HD
- WB142L



Code



<b>WBRKITS</b>	1
----------------	---

WHEELBARROWS & TRUCKS

**Contractors 85 Litre Wheelbarrow**

- 85 litre heavy duty press pan
- Tubular frame

WB85LS



WBRKITS

Code



**WB85LE** With pneumatic tyre 1

**WB85LS** With solid tyre 1

**Polypropylene 120 Litre Wheelbarrow**

- 120 litre heavy duty polypropylene pan
- Welded leg drop nose 32mm frame
- Pneumatic tyre



Code



**WBP120** 1

**Heavy Duty Steel 90 Litre Wheelbarrow**

- 90 litre heavy duty press pan
- Integral front tubular support
- 4 Ply 400 x 8 pneumatic tyre



Code



**WB90HD** 1

**Twin wheel 142 Litre Wheelbarrow**

- 142 litre heavy duty
- Tubular front tipper bar
- Heavy duty frame
- Pram handle
- Pneumatic tyres



Code



**WB142L** 1

**Premium Sack Truck**

- Choice of pneumatic tyres or solid wheels



Code



**SCT02** With pneumatic tyre 1

**SCT04** With solid wheels 1

**Pallet Truck**

- 2500kg capacity
- Fits Euro pallets
- Single rollers



Code



**HGPT105225** 1

## BROOMS & HANDLES

### Platform Bassine (Hard) Broom c/w Handle & Stay

- 1200mm long handle
- 300mm heads take 23mm dia. handle
- All other size heads take 28mm dia. handles



Code



<b>BRHB300</b>	300mm (12")	5
<b>BRHB450</b>	450mm (18")	5
<b>BRHB600</b>	600mm (24")	5
<b>BRHB900</b>	900mm (36")	5

### Platform Coco (Soft) Broom c/w Handle & Stay

- 1200mm long handle
- 300mm heads take 23mm dia. handle
- All other size heads take 28mm dia. handles



Code



<b>BRSC300</b>	300mm (12")	5
<b>BRSC450</b>	450mm (18")	5
<b>BRSC600</b>	600mm (24")	5
<b>BRSC900</b>	900mm (36")	5

### PVC Broom c/w Handle & Stay

- 1200mm long handle
- 300mm heads take 23mm dia. handles
- All other size heads take 28mm dia. handles



Code



<b>BRPVC300</b>	300mm (12")	5
<b>BRPVC450</b>	450mm (18")	5
<b>BRPVC600</b>	600mm (24")	5
<b>BRPVC900</b>	900mm (36")	5

### Concrete Finishing Broom c/w Handle & Stay



Code



<b>BRCON450</b>	450mm (18")	5
<b>BRCON600</b>	600mm (24")	5
<b>BRCON900</b>	900mm (36")	5
<b>BRCON1200</b>	1200mm (48")	5

**BROOMS & HANDLES**

**Sherbro Broom**

- Takes handle size 28mm (1 1/8")
- 330mm (13") width
- Available as head only or complete with handle and clamp



Code		📦
<b>BRSHB330</b>	Head only	5
<b>BRSHB330-KIT</b>	Complete broom	5

**Metal Broom Handle Clamps**



BHCFB



BHCSB

Code		📦
<b>BHCFB</b>	Flat heads	5
<b>BHCSB</b>	Saddle heads	5

**Coco Broom Head**

- Takes handle size 23.5mm (1 3/16")
- 300mm (12") width or 250mm (11") width



Code		📦
<b>BRSCH250</b>		5
<b>BRSCH300</b>		5

**Heavy Duty Poly Bristle Broom**

- Takes handle size 28mm (1 1/8")
- 330mm (13") width
- Available as head only or complete with handle and clamp



Code		📦
<b>BR630513</b>	Head only	5
<b>BR630513-KIT</b>	Complete broom	5

**Contractor Head**

- Takes 28mm handle
- 330mm (13")

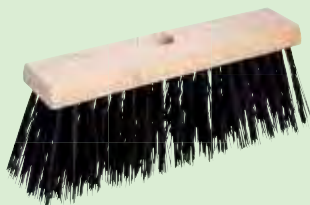

Code		📦
<b>BRPVCH330</b>		5

**Bass Broom Head**

- Takes handle size 28mm (1 1/8")
- 330mm (13") width



Code		📦
<b>BRHBH300</b>		5

**Wooden Broom Handles/Stales**

- 250/300mm (10/12") heads use 23.5mm
- 450mm (18") plus heads use 28mm

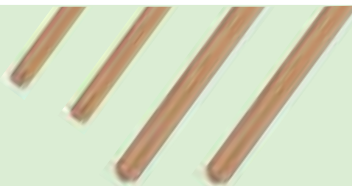

Code		📦
<b>BH415</b>	1200 x 23.5mm (48 x 1 3/16")	5
<b>BH511</b>	1350 x 28mm (54 x 1 1/8")	5
<b>BH515</b>	1370 x 23.5mm (55 x 1 3/16")	5
<b>BH411</b>	1200 x 28mm (48 x 1 1/8")	5
<b>BH611</b>	1500 x 28mm (60 x 1 1/8")	5

MAULS, MALLETS, KERB LIFTERS & SLEDGE HAMMERS

Rubber Maul & Handle

- 10lb



Code		
<b>MLR01</b>	Maul & handle	1
<b>MLR01SH</b>	Handle only	1

Wood Maul c/w Handle



**NON SPLIT HEAD**



Code		
<b>MLW01</b>	Maul & handle	1
<b>MLW01SH</b>	Handle only	1

Rubber Mallet

**WHITE NON MARKING**



Code		
<b>ML16BLK</b>	16oz Black	12
<b>ML24BLK</b>	24oz Black	12
<b>ML32BLK</b>	32oz Black	12
<b>ML16WHT</b>	16oz White	12
<b>ML24WHT</b>	24oz White	12
<b>ML32WHT</b>	32oz White	12

Kerb Lifter

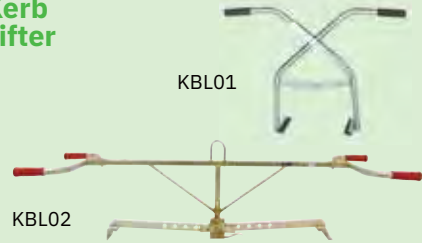

Code		
<b>KBL01</b>	1 Man	1
<b>KBL02</b>	2 Man	1

Sledge Hammer - Wooden Handle



Code		
<b>SHW07</b>	7lb	2
<b>SHW10</b>	10lb	2
<b>SHW14</b>	14lb	2

Sledge Hammer - Fibreglass Handle



Code		
<b>SHF07</b>	7lb	2
<b>SHF10</b>	10lb	2
<b>SHF14</b>	14lb	2

Sledge Hammer - Fully Insulated

- Fully conforming and individually tested and certified to BS8020: 2012 tools for live working
- Each tool is issued an individual, fully traceable number and certificate of conformity



Code		
<b>SHINS07</b>	7lb	2
<b>SHINS14</b>	14lb	2

BUCKETS

**Black Plastic Bucket**



- 14 litre (3 gallon)



Code  **BS15** 1

**Unbreakable Bucket**

- 14 litre (3 gallon)



Code  **BU15** 1

**Rubbertex Heavy Duty Bucket**

- Black 14 litre (3 gallon)
- Especially suitable for mixing building materials



Code  **BRT** 1

**Washboy Bucket Set**



Code  **FWSHK01** 1

**Replacement Cleaning Sponge**

- For use with Washboy Bucket Set



Code  **BR1640** 1

**Plastic Mop Bucket**

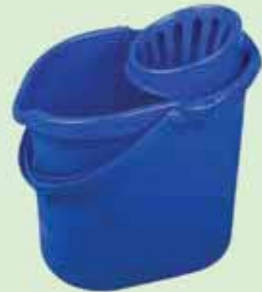

Code  **BPM15** 1

**Galvanised Bucket**

- 14 litre (3 gallon)



Code  **BG15** 1

**Flexi Tub**



Code  **BF20** 20L 1  
**BF42** 42L 1  
**BF60** 60L 1

**Galvanised Mop Bucket c/w Wringer Cone**

- 7 litre (1.5 gallon)



Code  **BM20** 1

**MORTAR TUBS & WATERING CANS**

**Eco Mortar Tub**

- 250 litre capacity
- Fork liftable



Code

**ECMT250**



1

**Mortar Mixing Tray**

- Size: 1000 x 1000mm (39 x 39")



Code

**MMT1000**



1

**Crane Lift Mortar Tub**

- Universal
- 300 litre



Code

**CLMT300**



1

**Galvanised Tar Bucket**

- 14 litre (3 gallon)



Code

**BT15**



1

**Rose Only**

- To fit galvanised cans



Code

**WATR**



1

**Galvanised Tar Can c/w Wide Spout**

- 14 litre (3 gallon)



Code

**BTCAN**



1

**Galvanised Watering Can**



Code

**WATG09**



1

**WATG13**

1

**Grass Seed**

- 20kg bag of high quality grass seed
- PM51 Grade
- 35g per m<sup>2</sup>
- 500m<sup>2</sup> per 1 bag



Code

**GS20**



5

**Plastic Watering Can**

- 9 litre (2 gallon)
- Complete with rose



Code

**WATP09**



1

**Site Water Butt**

- 340 litre (75 gallon)
- 710mm opening



Code

**WATB340**



1



## MAX 10 Litre Heavy Duty Professional Dust Suppression Water Bottle

**BEST  
SELLER**

- **ROBUST POLYETHYLENE CASING**  
Maximum durability for harsh environments
- **STRONG & STABLE BASE**  
Protects the bottom of the bottle & gives extra stability in use
- **BUILT IN WATER FILTER**  
Prevent blockages from dust & dirt



**DUST INGRESS PREVENTION COVER**  
Prevent dust & dirt getting into the bottle when refilling

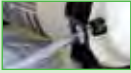

**PROTECTED HOSE CONNECTION**  
Prevents damage or breakage during use



**4 METRE TRANSPARENT HOSE**  
Extra working length

- 10 litre Capacity
- Heavy duty carry handle
- Durable pump with Steel Piston
- Supplied with hose connector
- Fits all saws including Stihl, Husqvarna, Makita etc.
- All spare parts available
- Made in Germany



Code

**OT10L**



## MAX 15 Litre Dust Suppression Water Bottle

- MAX 15 litre heavy duty water bottle for dust suppression (to suit all common petrol cut-off saws)
- Highly recommended by HSE for dust control on cut-off saws used for stone and concrete cutting. Can also be used to suit drill rigs
- Parts available
- 15 litre capacity
- Heavy duty carry handle
- Durable pump
- Supplied with hose connector
- Fits all saws including Stihl, Husqvarna, Makita etc.



Code

**OT15L**



ORDER **6AM TO 7PM** FOR NEXT MORNING DELIVERY

Set up an account for our discounted rates / prices

## DUST SUPPRESSION BOTTLES & WATER CONTAINERS

### MAX 10 Litre Metal Dust Suppression Water Bottle

- Strengthened steel tank with polyester coating for extra durability on site
- 2.5m hose & connector
- Pressure release valve & pressure gauge
- Sturdy base
- 10 litre capacity
- Heavy duty carry handle
- Durable pump
- Fits all saws including Stihl, Husqvarna, Makita etc.



Code



OT20L

1

### MAX 15 Litre Wheeled Dust Suppression Water Bottle

- Translucent tank - easy to see water level
- Wide funnel top
- Safety valve and pressure indicator
- Quick-fit coupling for easy use
- Hose holder spring, reduces chance of splitting
- Heat and frost resistant wired hose - 4m length



Code



OTW15L

1

### Plastic Liquid Container

- Tap not included as standard
- Tap for 25 litre bottle only



WATTAP



WAT25L

Code



WAT05L 5 Litre

1

WAT10L 10 Litre

1

WAT25L 25 Litre

1

WATLID25 Lid (to suit WAT25L)

1

WATTAP Tap (separate)

1

### Hand Held Water Sprayer

- 2 litre capacity
- Pressure gauge & safety valve



Code



MAXSPRAY2 2 Litre

1

### Premium Water Sprayer With Lance

- 5 litre capacity
- Pressure gauge & safety valve
- Sturdy hand pump



Code



MAXSPRAY5 5 Litre

1

### Sprayer Lance

- 500mm
- Fits MAXSPRAY5

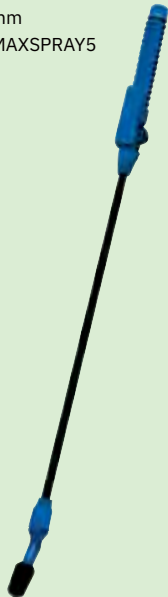

Code



LAN500

1

### Knapsack Backpack Sprayer

- 16 litre pressure sprayer



Code



MAXSPRAY16

1

### Hand Held Trigger Spray Bottle

- 500ml or 1 litre
- Suitable for chlorus



Code



WS500ML

12

WS1000ML

12

## SPRAYERS

### Professional Formwork Oil Sprayer

- 5 litre Capacity
- Pressure gauge & safety valve
- 6 bar (88psi)
- Viton seals for chemical resistance



Code

WS500P



1

### MAX Professional Sprayer

- Filling contents: 5 litre
- Total contents: 7 litre
- Operating pressure: 3 bar (44psi)
- Weight when empty: 1.7kg
- Tank: Plastic with large pressure reservoir
- Carried at the side
- Seals: FPM
- Nozzle: Flat-jet plastic nozzle
- Spray wand: Plastic, 50cm, 360° rotatable
- Hose: 2m, transparent, oil resistant
- Viton seals for chemical resistance



Code

CONSPRAY5



1

**Snow Scoop**

- Large snow scoop
- Fitted with wooden handle



Code

**SNSSL**



5

**Snow Shovel**

- 2 part snow shovel with detachable handle



Code

**SHSN01**



5

**Screen De Icer**

- 500ml spray can



Code

**DE500**



12

**Screen Wash**

- 5 litre
- Ready mixed



Code

**SWASH**



4

WINTER ESSENTIALS

Grit Bins

- Colour: Yellow



Code



JLGRIT250Y	250 litre	5
JLGRIT450Y	450 litre	5

Mobile Salt Spreader

- Easy to use
- 20cm poly wheels
- Adjustable gear box
- Spread width up to 2 metres
- Rustproof holder
- 18kg hopper capacity



Code



SS100		1
-------	--	---

Rock Salt

- 20kg bag of brown rock salt
- Pallet rates on request



Code



RSW01		50
-------	--	----

# HAND TOOLS



Club Hammers & Claw Hammers	86
Hammers & Mallets	87
Floats & Trowels	88-91
Striking Tools & Wrecking Bars	92
Spirit Levels	93
Hand Saws	94-95
Knives & Floorscrapers	96
Files & Grease Guns	97
Spanners	98
Screwdrivers & Allen Keys	99
Sockets & Magnets	100
Sockets & Ratchets	101
Pliers & Grips	102
Bolt Croppers, Cutters & Snips	103
Tool Box, VDE Pliers, Stillsons & Staple Guns	104
Brushes & Pencils	105
Pipe Cutters & Gas Torch Equipment	106

CLUB HAMMERS & CLAW HAMMERS

Club Hammer

- Hardwood handle

**BEST SELLER**



Code		
<b>CHW25</b>	2.5lb	6
<b>CHW4</b>	4lb	6

Club Hammer

- Hickory handle



Code		
<b>CHH25</b>	2.5lb	6
<b>CHH4</b>	4lb	6

Club Hammer

- Fibreglass shaft
- Non slip handle



Code		
<b>CHF25</b>	2.5lb	6
<b>CHF4</b>	4lb	6

Claw Hammer

- Steel shaft
- Non slip handle



Code		
<b>CLHE16</b>	16oz	6
<b>CLHE20</b>	20oz	6

MAX Claw Hammer

- Fibreglass shaft
- Non slip handle

**BEST SELLER**

**MAX**  
QUALITY.  
UNMATCHED.



Code		
<b>CLHF16</b>	16oz	6
<b>CLHF20</b>	20oz	6

Professional Claw Hammer

- Steel shaft
- Solid forged



Code		
<b>CLHP16</b>	16oz	6
<b>CLHP20</b>	20oz	6



**Single Headed Scutch Hammer**

- 20oz
- Hickory handle



Code  **CLSC01** 6

**Scutch Replacement Combs - Pack of 5**

- 25mm combs

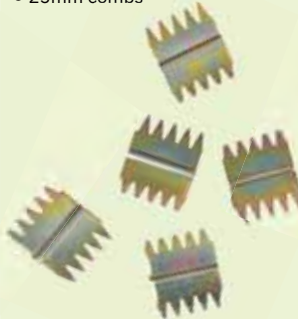

Code  **CLSCB5** 6

**Bricklayers Hammer**



Code  **BLH01P** 6

**Chipping Hammer - Wooden Handle**

- 1lb
- Forged steel head
- Wooden handle



Code  **CHE20** 6

**Chipping Hammer - Fibreglass Handle**

- 1lb
- Forged steel head
- Fibreglass handle



Code  **CHPF16** 6

**Chipping Hammer - Professional**

- 1lb
- Forged steel head
- Fibreglass handle



Code  **CT0242** 6

**Rubber Mallet**



**WHITE  
NON  
MARKING**

Code		
<b>ML16BLK</b>	16oz Black	12
<b>ML24BLK</b>	24oz Black	12
<b>ML32BLK</b>	32oz Black	12
<b>ML16WHT</b>	16oz White	12
<b>ML24WHT</b>	24oz White	12
<b>ML32WHT</b>	32oz White	12

FLOATS & TROWELS

Plastic Float



Code		
<b>FTP280</b>	280 x 110mm (11 x 4")	20
<b>FTP320</b>	320 x 180mm (12.5 x 7")	20

Wooden Float



Code		
<b>WDFLT</b>	292 x 114mm (11.5 x 4.5")	24

Plasterers Hawk

- 330 x 330mm



Code		
<b>FTPH330</b>		15

Plastering Trowel

- Wooden handle



Code		
<b>FTPT455</b>	455 x 120mm (18 x 5")	5

Gauging Trowel

- Wooden handle

**BEST SELLER**



Code		
<b>TRG180</b>	180mm (7")	12

Bullnose Flooring Trowel

- Wooden handle



Code		
<b>FTBN01</b>	410 x 120mm (16 x 5")	6

Bricklaying Trowel

- Wooden handle



Code		
<b>TRB250</b>	250mm (10")	5

Pointing Trowel

- Wooden handle



Code		
<b>TRP150</b>	150mm (6")	5

**Professional Brick Trowel - Philadelphia Pattern**

- Rubber handle



Code

**TRB250P** 250mm (10")



6

**Professional Brick Trowel - London Pattern**

- Rubber handle



Code

**TRB275P** 275mm (11")



6

**Professional Gauging Trowel**

- Rubber handle



Code

**TRG180P** 180mm (7")



6

**Professional Pointing Trowel**

- Rubber handle



Code

**TRP150P** 150mm (6")



6

**Professional Flooring Trowel**

- Rubber handle



Code

**TRF400P** 405 x 115mm (16")



6

**TRF450P** 450 x 115mm (18")

6

**Professional Cement Finishing Trowel**

- Rubber handle



Code

**FTPT355P** 356 x 120mm (14")



6

**FTPT450P** 405 x 115mm (16")

6

FLOATS & TROWELS

London Brick Trowel

- London pattern
- Durable hardened steel blade
- Soft grip handle to enhance user comfort



Code  **T10610ST** 250mm (10") **6**

Gauging Trowel

- Durable hardened steel blade
- Used primarily for mixing and applying small quantities of cement
- Soft grip handle to enhance user comfort



Code  **T1367ST** 180mm (7") **6**

Bucket Trowel

- Carbon steel blade, hardened and tempered
- Rounded corners on the tip
- Soft grip handle to enhance user comfort



Code  **T137S** 180mm (7") **6**

London Pointing Trowel

- London pattern
- Durable hardened steel blade
- Soft grip handle to enhance user comfort



Code  **T1066ST** 150mm (6") **6**

Edging Trowel 3"

- Durable hardened steel blade
- Soft grip handle to enhance user comfort



Code  **T8308** 150 x 75mm (6 x 3") **6**

Professional Edging Trowel 4 3/4"

- Carbon steel blade
- Soft grip handle



Code  **TRE100** 280 x 120mm (11 x 4 3/4") **6**

FLOATS & TROWELS

Finishing Trowel - Small

- Strong and durable carbon steel blade which is fixed with invisible rivets
- Soft grip handle to enhance user comfort



Code

**T124BST** 280 x 115mm (11 x 4½")



6

Finishing Trowel - Medium

- Strong and durable carbon steel blade which is fixed with invisible rivets
- Soft grip handle to enhance user comfort



Code

**T135** 325 x 115mm (13 x 4½")



6

Finishing Trowel - Large

- Strong and durable carbon steel blade which is fixed with invisible rivets
- Soft grip handle to enhance user comfort



Code

**T16** 400 x 115mm (16 x 4½")



6

Flooring Trowel

- Strong and durable carbon steel blade which is fixed with invisible rivets
- Soft grip handle to enhance user comfort



Code

**T2015** 400 x 115mm (16 x 4½")



6

Brick Jointer



Code

**TRBJ012** 10 - 13mm (0.5")



6

Finishing Trowel with Rubber Handle

**BEST SELLER**



Code

**TRF01** 280 x 115mm (11 x 4.5")



6

STRIKING TOOLS & WRECKING BARS

Brick Bolsters

- With protection guard



Code		
<b>BBG02</b>	57mm (2¼")	6
<b>BBG03</b>	75mm (3")	6
<b>BBG04</b>	100mm (4")	6

Brick Bolsters

- Without protection guard



Code		
<b>BBW04</b>	100mm (4")	6

Cold Chisels

- Hex cold chisel



Code		
<b>CC13150</b>	13 x 150mm (0.5 x 6")	6
<b>CC19250</b>	19 x 250mm (0.75 x 10")	6
<b>CC25250</b>	25 x 250mm (1 x 10")	6
<b>CC25300</b>	25 x 300mm (1 x 12")	6

Wrecking Bars

- For demolition and general use



Code		
<b>WRECK450</b>	450mm (18")	6
<b>WRECK600</b>	600mm (24")	6
<b>WRECK750</b>	750mm (30")	6
<b>WRECK900</b>	900mm (36")	6

Plugging Chisel

- 250 x 15mm (10 x 0.6")



Code		
<b>PC250</b>		6

Cold Chisel with Guard

- 19mm width
- With protection guard



Code		
<b>CCG25</b>		1

SPIRIT LEVELS

Trade Spirit Levels

Sizes available:  
600mm (24")  
900mm (36")  
1200mm (48")  
1800mm (72")

FROM ONLY  
**5.54**



Code	
SLT24	1
SLT36	1
SLT48	1
SLT72	1

MAX Professional Spirit Level

Sizes available:  
600mm (24")  
900mm (36")  
1200mm (48")  
1800mm (72")



MAGNETIC

BEST  
SELLER



Code	
SLP24	1
SLP36	1
SLP48	1
SLP72	1

Stabila Spirit Level 70-2 Series

Sizes available:  
600mm (24")  
900mm (36")  
1200mm (48")  
1800mm (72")



Code	
STB70224	1
STB70236	1
STB70248	1
STB70272	1

Professional Boat Level

MAGNETIC



Code	
SLP09	225mm (9") 1

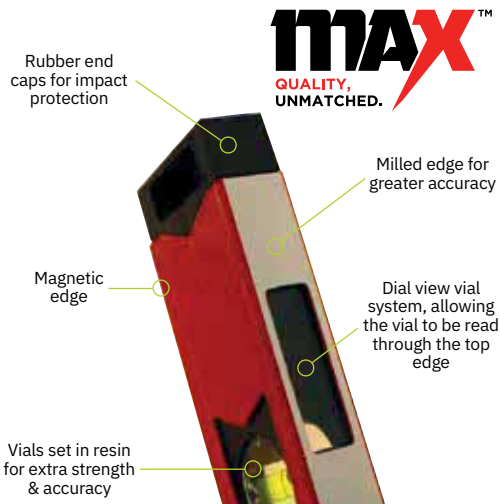

ORDER 6AM TO 7PM FOR NEXT MORNING DELIVERY

Set up an account for our discounted rates / prices

HAND SAWS

**MAX Trade  
Hard Point Saw**

- Premium quality, general purpose, hard point saw
- Fast-cut, rapid, clean cutting action
- Rigid blade minimises 'whip' and vibration
- 20"/500mm length
- 7TPI



Code

SAWE0



6

**Standard  
Multi Purpose Saw**

- 350mm
- Multi-positional to help clear obstacles



Code

SAWE02



6

**Irwin 880  
Hand Saw**

- Triple ground hardpoint teeth
- High quality C75 steel blade
- 20"/500mm length
- 8TPI



Code

IRWIN880



6



**Junior & Standard Hacksaws**



SAWHJ06



SAWH12S

Code		
<b>SAWHJ06</b>	6" Junior Hacksaw	10
<b>SAWH12S</b>	12" Standard Hacksaw	6

**Replacement Hacksaw Blades**

- 12" / 18TPI - (PK24)
- 6" / 32TPI - (PK10)



SAWHJ06R



SAWH12SR

Code		
<b>SAWHJ06R</b>	For 6" Junior Hacksaw	10
<b>SAWH12SR</b>	For 12" Standard Hacksaw	15

**BAHCO 319**

- Comfortable non slip handle
- With front grip
- Supplied with three blades
- Replacement Sandflex Bi-Metal blades 18TPI (Pack 2)



SAWH12P

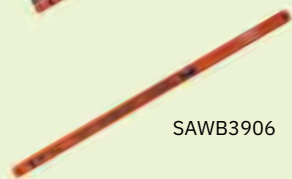

SAWB3906

Code		
<b>SAWH12P</b>		10
<b>SAWB3906</b>		10

**Bow Saw**

- 24"



Code		
<b>SAWB24</b>		6
<b>SAWBB</b>	Blade	10

**Pad Saw**



Code		
<b>SAWPAD</b>		10

KNIVES & FLOORSCRAPERS

**MAX Auto Retract Safety Knife**

- Steel construction
- Soft grip handle
- With box opener blade
- Safety blade change system



Code  **KNF004** 12

**Retractable Blade Trimming Knife**



Code  **KNF001** 12

**Quick Blade Change Trimming Knife**



Code  **KNF002K** 12

**Stanley 99E Retractable Blade Knife**



Code  **STA210099** 12

**Martor Auto Retract Safety Knife**



Code  **M101899** Knife 10  
**M101900** Pack of 10 blades 10

**Heavy Duty Floor Scraper**

- 8" stainless steel anti-corrosion replaceable blade (see **FLSCHDRB** below)
- 48" hardwood handle



Code  **FLSCHD** 12

**Retractable Knife Blades**

- Unique safe removal feature



Code  **KNF002B** Pack of 10 1  
**KNF003** Pack of 100 1

**Replacement Blades**

- 8" stainless steel anti-corrosion blade
- To fit **FLSCHD** (above)



Code  **FLSCHDRB** 5

FILES & GREASE GUNS

**Bastard File**



Code		
<b>FLHRB250</b>	250mm - Half round	12
<b>FLFB250</b>	250mm - Flat	12
<b>FLFB300</b>	300mm - Flat	12

**Carborundum Stone**

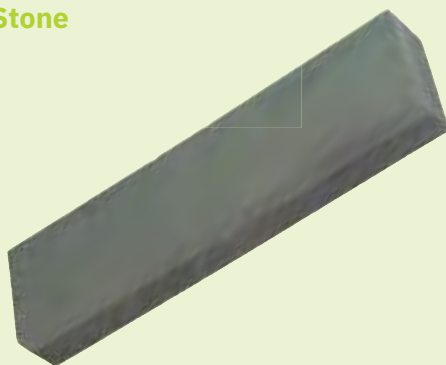

Code		
<b>CS200</b>		12

**Pipe Grease**

- An environmentally friendly vegetable oil soap-based pipe jointing lubricant with universal application
- Suitable for lubricating all types of pipe material



Code		
<b>PG25KG</b>		20

**Concrete Rubbing Brick**



Code		
<b>CRB150</b>		10

**Grease Gun**

- 500cc
- Takes standard 400g cartridges (see **GGC400** right)



Code		
<b>GG500</b>		1

**MAX Grease Gun Cartridge**

- Lithium EP2 grease
- Available in 400g cartridge or 12.5kg tub



ENQUIRE FOR BULK RATES

GGC400

Code		
<b>GGC400</b>	400gm tube	36
<b>EP4530</b>	12.5kg tub	1

SPANNERS

Combination Spanner



Code	Jaw Size	Length	
SPC6P	6mm	125mm	10
SPC7P	7mm	127mm	10
SPC8P	8mm	130mm	10
SPC9P	9mm	135mm	10
SPC10P	10mm	140mm	10
SPC11P	11mm	150mm	10
SPC12P	12mm	170mm	10
SPC13P	13mm	170mm	10
SPC14P	14mm	190mm	10
SPC15P	15mm	205mm	10
SPC16P	16mm	205mm	10
SPC17P	17mm	225mm	10
SPC18P	18mm	235mm	10
SPC19P	19mm	245mm	10
SPC20P	20mm	260mm	10
SPC21P	21mm	270mm	10
SPC22P	22mm	285mm	10
SPC23P	23mm	300mm	10
SPC24P	24mm	310mm	10
SPC25P	25mm	325mm	10
SPC26P	26mm	310mm	10
SPC27P	27mm	345mm	10
SPC28P	28mm	350mm	10
SPC29P	29mm	360mm	10
SPC30P	30mm	375mm	10
SPC32P	32mm	390mm	10

Combination Spanner Set

- 1 of each of all above
- 6mm - 32mm jaw size

Code	
SPCSET	1

Chrome Vanadium Combination Spanner Set

- Professional, hardened, tempered and satin chrome plated for corrosion protection.
- DIN 3113 Manufactured
- 18 piece set contains: 6, 7, 8, 9, 10, 11, 12, 13, 14, 15, 16, 17, 18, 19, 20, 21, 22 and 24mm.



Code	
FAISPASET18	2

Adjustable Spanner

- Narrow jaw
- Drop forged and chrome plated carbon steel



Code	Jaw Size	Length	
SPA6P	19mm	150mm	1
SPA8P	24mm	200mm	1
SPA10P	29mm	250mm	1
SPA12P	34mm	300mm	1
SPA15P	45mm	375mm	1
SPA18P	55mm	450mm	1
SPA24P	62mm	600mm	1

Scaffold Spanner

- Double ended
- Swing over handle
- Hardened carbon steel socket
- Bright zinc plate finish

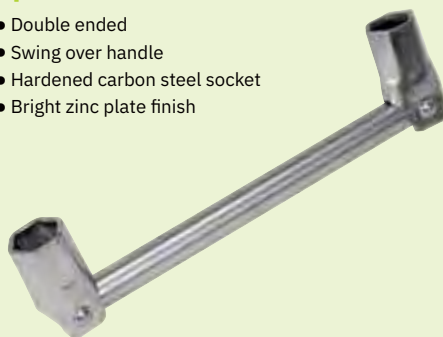

Code	
SPSCA	6

### 7 Piece Insulated Screwdriver Set



Code

INSSET



12

### 7 Piece Screwdriver Set

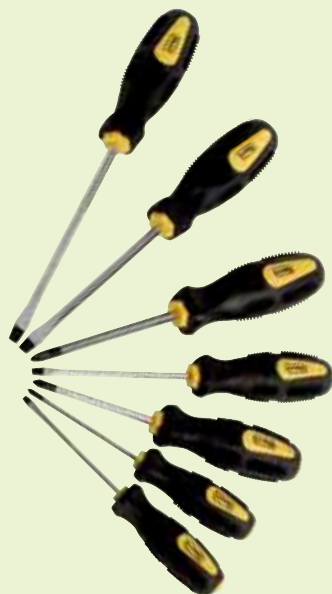

Code

SSET



5

### Allen Key Set

- Metric
- 1.5, 2, 2.5, 3, 4, 5, 5.5, 6, 8 & 10mm
- 10 piece set



Code

AKSETS



24

### Allen Key Set - Large

- 3, 4, 5, 6, 7, 8, 10, 12, 14 & 17mm
- 10 piece set



Code

AK33895



1

## SOCKETS & MAGNETS

### Premium Socket Set

- 42 piece mm/AF with ½" drive
- Complete with handy carry case



Code

**SST8**



1

### Deep Drive Socket Drive Metric

- ½" drive



Code

<b>SKTDD17</b>	17mm	12
<b>SKTDD19</b>	19mm	12
<b>SKTDD24</b>	24mm	12
<b>SKTDD27</b>	27mm	12
<b>SKTDD30</b>	30mm	12
<b>SKTDD32</b>	32mm	12



### Socket Drive Metric

- ½" drive



Code

<b>SKT10</b>	10mm	2
<b>SKT13</b>	13mm	2
<b>SKT17</b>	17mm	2
<b>SKT19</b>	19mm	2
<b>SKT24</b>	24mm	2
<b>SKT27</b>	27mm	2
<b>SKT30</b>	30mm	2
<b>SKT32</b>	32mm	2



### Socket Drive ¾"

- ¾" drive



Code

<b>SKT3419</b>	19mm	1
<b>SKT3424</b>	24mm	1
<b>SKT3427</b>	27mm	1
<b>SKT3430</b>	30mm	1
<b>SKT3432</b>	32mm	1



### Mini Magnet

- 50 x 20mm
- Extra strong



Code

**HM001**



10

**Impact  
Sockets**



Code		
<b>HSKT13-1/2</b>	13mm 1/2" drive	1
<b>HSKT16-1/2</b>	16mm 1/2" drive	1
<b>HSKT17-1/2</b>	17mm 1/2" drive	1
<b>HSKT19-1/2</b>	19mm 1/2" drive	1
<b>HSKT21-1/2</b>	21mm 1/2" drive	1
<b>HSKT24-1/2</b>	24mm 1/2" drive	1
<b>HSKT27-1/2</b>	27mm 1/2" drive	1

**Ratchet  
Handle**

- 1/2" drive
- Made from professional quality chrome vanadium steel



Code	
<b>RHD001</b>	6

**Heavy Duty  
Ratchet Handle**

- 1/2" drive
- Soft comfort grip



Code	
<b>RHD002</b>	6

PLIERS & GRIPS

Water Pump Pliers

- 240mm (9½")



Code

NCPWPP



6

Long Nose Pliers

- 150mm (6")



Code

NCPLNP



6

Combination Pliers

- 200mm (8")



Code

NCPCP



6

Mole Grips

- 230mm (9")



Code

NCPMG



6

Adjustable Pipe Wrench



Code

- NCPPW07 7"
- NCPPW09 9"
- NCPPW12 12"



6

6

6

Footprint Adjustable Wrench

- Genuine Footprint Brand



Code

- NCPPW07P 7"
- NCPPW09P 9"
- NCPPW12P 12"



6

6

6



## Bolt Croppers



Code



<b>NCPBC450</b>	450mm	6
<b>NCPBC600</b>	600mm	6
<b>NCPBC750</b>	750mm	4
<b>NCPBC900</b>	900mm	4

6

6

4

4

## End Cutters

- 180mm (7")



Code



**NCPEC150**

6

## Professional End Cutters

- 200mm (8")



**BEST  
SELLER**

Code



**NCPEC200**

6

## Side Cutters

- 150mm (6")



Code



**NCPSC**

6

## Tin Snips

- 200mm (8")



Code



**NCPTS**

6

TOOL BOX, VDE PLIERS, STILLSONS & STAPLE GUN

Hard Case Tool Box

- Robust metal latches
- Soft grip handle
- Built in padlock
- Removable tote tray
- 51cm (20") wide



Code



ST194858

1

VDE Pliers Set-3 Piece

- High quality drop-forged chrome vanadium
- Individually tested to 10,000V
- Conforms to DIN EN60900 (VDE4000 9659)
- Includes: Long Nose Pliers, Side Cutting Pliers, Combination Pliers



Code



VDEPSET

1

Stillson Wrench

- Serrated teeth for a secure grip
- Hardened long-life construction



Code



WR250	250mm (10")	1
WR300	300mm (12")	1
WR450	450mm (18")	1
WR600	600mm (24")	1
WR900	900mm (36")	1

Hand Staple Gun & Staples

- Arrow T50 staple gun
- Galvanised steel staples to suit
- Staples - boxes of 5000



Code



AT50PHS	Stapler	1
ARRT5038	10mm staples	1
ARRT5012	12mm staples	1

**CMT Carpenter's Pencil Pack**

- Pack of 12



Code

**T022910**

12

**Standard Pencils**

- Pack of 12
- HB



Code

**WX01117**

12

**Short Handled Tar Brush**

Code

**TARBSH**

1

**Long Handled Tar Brush**

Code

**TARBLH**

10

**4 Row Wire Brush**

Code

**WB4**

1

**4 Row Wire Brush with Scraper**

Code

**WB6RSC**

6

PIPE CUTTERS & GAS TORCH EQUIPMENT

PVC Pipe Cutter

- Capacity 4 - 42mm



Code

NCPVPC



6

Pipe Slice

- 15mm or 22mm



Code

NCPPC15 15mm

NCPPC22 22mm



1

1

MAX Gas Lance & Torch

- 1000mm
- Adjustable flame intensity
- 50mm burner
- Pilot flame
- For use with propane
- Also available in double or triple head

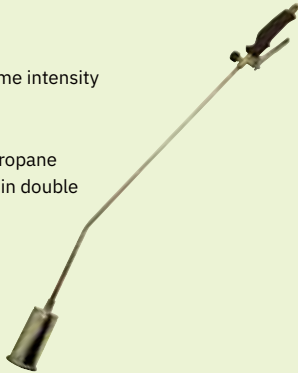

Code

RTGL



1

Gas Lance & Torch Kit

- Contains gas lance, torch, hose and regulator



Code

RTGKIT



1

Gas Hose

- 2m length



Code

RTGH



1

Propane Gas Regulator

- High pressure regulator



Code

RTGR



1

# TOOL TETHERING



Tethering Your Tools	108
Common Tether Points	110-111
Tool Lanyards	112-113
Anchor Points	114
Tether Accessories & Storage	115
Learning Hub Board	116

TETHERING YOUR TOOLS

# ON SITE, SAFETY WHEN WORKING AT HEIGHT IS PARAMOUNT

Dropped tools present a danger at almost any height, regardless of the tool weight and this ingenious and hassle-free tethering system significantly decreases the chance of tools being dropped. **It's simple:** follow the three steps and select the correct product for your task from each step to complete your unique tethering system.

## 1

### COMMON TETHER POINTS

Not all tools are created tether-ready. It's as easy as creating a secure attachment point on the tool you are using and ensuring the tool weight does not exceed the maximum allowed for the tether point. Go to pages 110-111

## 2

### TOOL LANYARDS

Choosing the best tool lanyard for the job depending on the task and weight of the tool ensures safety first in your working environment. Go to pages 112-113

## 3

### ANCHOR POINTS

Every tool lanyard needs an anchor. Whether it's on your wrist or belt, make sure it's secure with one of these weight rated anchors. Suggested maximum tool weights for wrist anchor are 1.5kg and for belt anchor 2.5kg. Go to page 114

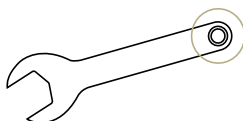

Captive Holes

Holes built into the body of the tool

- Instant Tether System
- Tether Loop
- Tether Ring
- 360° D-Ring Loop
- 8 Ring Tether

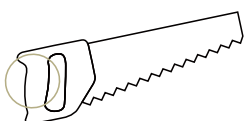

Captive Handles

Closed loop built into the structure of the tool

- D-ring loop,
- Triple Lock

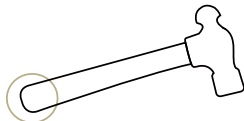

Open-Ended Handles

Open at one end with no captive holes

- 360° Sleeve Adaptor
- Instant Tether System
- D-ring
- Tether Tape

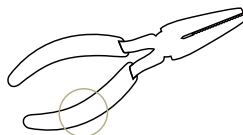

Moulded Grips

Open ended shaped handles found on small tools

- 360° Sleeve Adaptor
- Instant Tether System
- D-ring
- Tether Tape

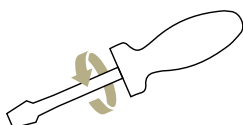

Rotating Holes

Tools that require rotation to perform their function

- 360° Sleeve Adaptor
- Instant Tether System
- 8 Ring Tether

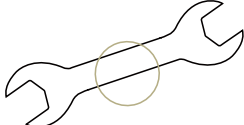

Rotating Tools

Tool performed with a tapered mid-section

- Tether Ring
- Instant Tether System

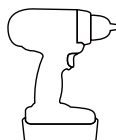

Waisting Tools

Large tools with a built-in waist or thin mid section

- Drill Boot Tether
- Tether Choke
- Instant Tether System
- Tether loop
- Tether Ring

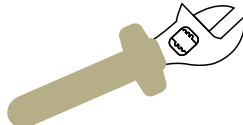

Insulated Tools

Non-conducted tools for maintenance & electrical work

- Instant Tether System
- Non conductive D-ring
- Tether tape



neverletgo.com

# Your tools made safe. For less.

The New NLG Go Range brings you safety you can trust at a great price.



101518  
NLG GO Bungee Tool Lanyard  
CMT Code: **NLG101518**  
(See page 113)



101519  
NLG GO Bungee Tool Lanyard, Twin  
CMT Code: **NLG101519**  
(See page 113)

## Tether any tool in 3 simple steps



### Tether Point

Create a secure attachment point on the tool.



### Tool Lanyard

Choose the best tool lanyard for your task.



### Anchor Point

Select between a wristband, belt, harness or fixed point.



### Video Guide

Watch how to install every tether point:

[neverletgo.com/guide](https://neverletgo.com/guide)



# 1: COMMON TETHER POINTS

## Tether Loop

- Aircraft-grade steel core



Code		
NLG101380	120mm	10
NLG101381	150mm	10

## Tether Ring

- Quickly tether small tools with captive holes (spanners, screwdrivers etc.), also suitable as an inline weak-link connector
- 25 or 38mm diameter

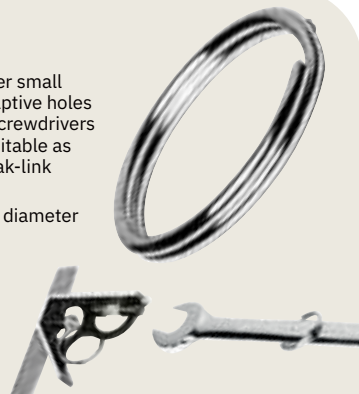

Code		
NLG101273	25mm	10
NLG101275	38mm	10

## Tether Choke

- Heavy duty, highly durable webbing



Original

Single arm

Twin arm



Code		
NLG101367	Original	10
NLG101368	Single arm	10
NLG101369	Twin arm	10

## 360° D-Ring Loop

- Provides direct tool attachment by choking / looping through drilled or preformed holes and captive handles, toggle allows easy and secure fastening
- D-Ring attachment point, cord length 18cm, total length 28cm



Code		
NLG101363		10

## Tape Measure Tether

- For standard & XL sizes



Code		
NLG101350		1

## Triple Lock

- Allows quick addition of heavy duty anchor points
- Extreme tensile strength
- Can be used to tether large hand tools

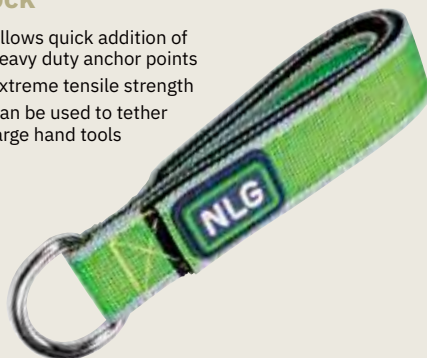

Code		
NLG101454		10



1: COMMON TETHER POINTS

8 Ring Tether

- Hard wearing
- Versatile & easy to use



Code		
NLG101426	Medium	5
NLG101427	Large	5

Drill Boot Tether

- Drill not included



Code		
NLG101334	Small	1
NLG101333	Large	1

Instant Tether System

- Self-fusing Tether Tape does not need heat to apply and features fibreglass reinforcement mesh for improved strength & durability

Tether Tape

- 2.8m roll
- 1 roll tethers up to 10 tools



D-Ring Tool Tethers



Code		
NLG101355	Tether Tape	1
Code		
NLG101361	Small D-Ring	10
NLG101362	Large D-Ring	10
NLG101375	Non-Conductive D-Ring	10

## 2: TOOL LANYARDS

### Helmet Lanyard

- 40 x 2cm
- Secure & comfortable
- Helmet not included
- For use with all hard helmets. See pages 320-323



Code

**NLG101358**



5

### Medium Duty Bungee Lanyard

- Extends 80 to 120cm
- Strong & versatile



Code

**NLG101372**



5

### Heavy Duty Bungee Lanyard

- Extends 80 to 130cm
- Heavy duty



Code

**NLG101373**



5

### Heavy Duty Webbing Lanyard

- 190cm
- Super heavy duty



Code

**NLG101374**



5

### Retractable Lanyard

- Extends 30 to 140cm
- With locking mechanism



Code

**NLG101389**



1

### Coiled Lanyard

- Extends 10 to 170cm
- Compact & anti-tangle



Code

**NLG101370**



5

## 2: TOOL LANYARDS

### Mini Coiled Lanyard

- Extends 30 to 95cm
- Compact & lightweight for small tools & equipment



Code

NLG101371



10

### Lightweight Coiled Lanyard

- Extends 48 to 180cm



Code

NLG101493



5

### Short Coiled Lanyard

- Extends 4 to 70cm
- Non-conductive



Code

NLG101376



10

### Short Coiled Lanyard

- Extends 4 to 70cm
- With 360° Quick Clips



Code

NLG101364



10

### GO Tool Lanyard

- Extends 70 to 120cm
- Lightweight
- Entry level



Code

NLG101518



5

### GO Bungee Tool Lanyard

- Extends 70 to 120cm
- Lightweight
- Twin carabiner



Code

NLG101519



5

### 3: ANCHOR POINTS

#### Wrist Band

- Suggested maximum tool weight when anchored to wrist: 1.5kg
- Comfortable & adjustable



Code

NLG101365



10

#### Belt Loop

- Suggested maximum tool weight when anchored to belt: 2.5kg
- Fits all standard belts



Code

NLG101366



10

#### Work Belt

- Comfortable & adjustable



Code

NLG101420



1

#### Heavy Duty Choke Anchor

- For fixed anchor point



Code

NLG101494



10

### Linesman Bag

- Heavy duty
- Reinforced mesh construction
- Waterproof & rot-proof



Code

**NLG101421**



1

### Aero™ Pouch

- Ideal for fixings & small drill bits
- Unique design



Code

**NLG101400**



1

### Tablet Case

- Fits all types of common tablets
- Touch sensitive



Code

**NLG101384**



1

### Phone Case

- Fits all types of common smart phones
- Touch sensitive



Code

**NLG101383**



1

### Radio Holder

- Fits all types of common radio



Code

**NLG101418**



10

LEARNING HUB BOARD

**NLG Tool Tethering Learning Hub**

- A high impact training and awareness tool to remind operators to tether up and a reference point on how they can do it
- A visual way to represent over 20 physical products



Code

**NLG101467**



1

**SITE VISITS AVAILABLE TO DISCUSS YOUR TOOL TETHERING REQUIREMENTS**

CALL US FOR MORE DETAILS  
**020 8311 1144**



# MEASURING & SURVEYING EQUIPMENT



Tape Measures & Road Wheel	118
Tape Measures	119
Line Marker Sprays	120
Spray Paint Applicators & Marking Crayons	121
Lasers & Accessories	122
Road Marking & Asphalt Release Agent	123-124
Road Repair	125
String Lines & Chalk Lines	126

TAPE MEASURES & ROAD WHEEL

Soft Grip  
Tape Measure

- Heavy Duty
- Robust, durable and flexible
- Convenient storage size
- Safety recoil function



Code		
TM5	5m	12
TM8	7.5m	12
TM10	10m	6

MAX Professional  
Tape Measure

- Tough long reach blade
- Self-lock system



Code		
MAX5	5m	6
MAX8	8m	6

Fisco BIG-T  
Tape Measure

- Ultra tough blade
- Unique snap-in belt holder



Code		
TMBT5M	5m	12
TMBT8M	8m	12

MAX Road  
Measuring Wheel

- Unique folding design
- Lightweight and easy to store (canvas rucksack storage bag)
- Trigger brake and reset control
- Built in kick stand and carry handle
- Hi traction PU tyre, 12/2" dia. wheel



Code		
RMW01		4



### MAX Closed Frame Tape Measure

- Nylon tape
- Fibreglass
- 30m



Code

**TMCF030** 30m



6

### MAX Open Frame Tape Measure

- Nylon tape



Code

**TMOF030** 30m

**TMOF050** 50m

**TMOF100** 100m



6

6

6

### Fisco CC Closed Frame Tape Measure - Steel Blade



Code

**FSCCX30ME** 30m

**FSCCX50ME** 50m



1

1

### Fisco Pacer Open Frame Tape Measure

- 30 or 100m



Code

**TMP30** 30m fibreglass blade

**TMP100** 100m fibreglass blade



1

1

### Steel Open Reel Tape Measure

- 30, 50 or 100m
- Steel 13mm ribbon
- Fast rewind
- Metric / Imperial
- Bump stop end



Code

**TMST030** 30m

**TMST050** 50m

**TMST100** 100m



1

1

1

## SETTING OUT PEGS & PROFILE BOARDS



SEE PAGE 149



LINEMARKER SPRAYS

**MAX Permanent Line Marker Spray**

- 750ml cans
- New improved formulation
- High colour pigment
- Fast drying
- Anti clog formula
- Price each



Code

<b>LMP-BLU</b>	Blue	12
<b>LMP-RED</b>	Red	12
<b>LMP-WHT</b>	White	12
<b>LMP-YEL</b>	Yellow	12
<b>LMP-ORA</b>	Orange	12
<b>LMP-BLA</b>	Black	12
<b>LMP-GRE</b>	Green	12
<b>LMP-GRY</b>	Grey	12

**MAX Temporary Line Marker Spray**

- 750ml cans
- New improved formulation
- High colour pigment
- Fast drying
- Anti clog formula
- Price each



Code

<b>LMT-BLU</b>	Blue	12
<b>LMT-RED</b>	Red	12
<b>LMT-WHT</b>	White	12
<b>LMT-YEL</b>	Yellow	12
<b>LMT-ORA</b>	Orange	12
<b>LMT-BLA</b>	Black	12
<b>LMT-GRE</b>	Green	12

Spray Paint Applicators

LMA01



LMA02



LMA03



Code		📦
<b>LMA01</b>	Handheld	12
<b>LMA02</b>	2 Wheel	12
<b>LMA03</b>	4 Wheel	12

Spot Marking Paint

- Premium quality temporary site marker
- Safety cap and clog free nozzle
- Available in several colours
- 750ml

NEW



Code		📦
<b>LMSPT-WHT</b>	White	6
<b>LMSPT-BLU</b>	Blue	6
<b>LMSPT-YEL</b>	Yellow	6
<b>LMSPT-RED</b>	Red	6

Marking Crayons

- Pack of 12 crayons

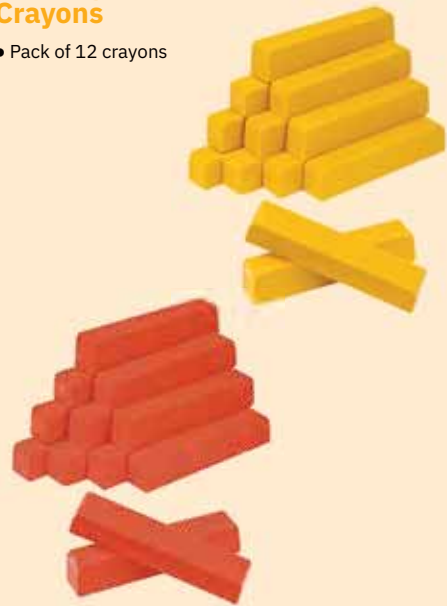

Code		📦
<b>MCY100-Y</b>	Yellow	12
<b>MCY100-R</b>	Red	12

LASERS & ACCESSORIES

66R Rotating Laser Kit

- Self levelling with bump stop
- Horizontal levelling
- Kit includes laser, tripod, receiver & staff



Code 📦  
**66RKIT** 1

Telescopic Staff

- 5m
- Lightweight aluminium
- Includes bubble and carry bag



Code 📦  
**TALSTAFF5** 1

Yellow Retro Targets

- High visibility in daylight
- Self adhesive
- Variety of sizes available
- Priced individually



Code 📦

<b>YRT20</b>	20mm	10
<b>YRT40</b>	40mm	10
<b>YRT60</b>	60mm	10

Silver Retro Targets

- High visibility in daylight
- Self adhesive
- Variety of sizes available
- Priced individually



Code 📦

<b>SRT20</b>	20mm	10
<b>SRT40</b>	40mm	10
<b>SRT60</b>	60mm	10

1m Folding Ruler

- Metric & Imperial measurements
- Very strong ABS plastic

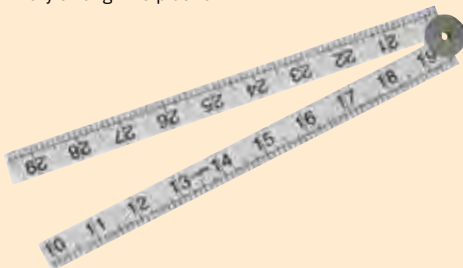

Code 📦  
**WR100** 1

Chartwell Survey Book

- Fully waterproof
- Printed in permanent ink



Code 📦  
**CSB2426** 1

## Easytack Primer

- Primer for preformed thermoplastic road markings
- Recommended when applying onto concrete or old bitumen
- 750ml aerosol
- Easy and clean to use
- Touch dry in approximately 10-15 minutes



Code



**AET75CL**

12

## Professional Torch Kit



Code



**THERMTKIT**

1

## Asphalt Release Agent

Now introducing the T99 - the most eco-friendly & reliable tarmac cleaner on the market. Available in multiple volumes!

Can be used for cleaning:

- Paving machines
- Groundwork tools
- Lorry beds & chassis
- Footwear & PPE



Code

**T6910LTR** 10 litres

**T6925LTR** 25 litres

ORDER **6AM TO 7PM** FOR NEXT MORNING DELIVERY

Set up an account for our discounted rates / prices

## ROAD MARKING

### Thermoplastic Line Marking Roll

- 5m length
- Create instant, permanent lines quickly and simply
- Ideal for reinstatements, car parks and roads
- Easy to apply with a gas torch
- 100mm - 10 per box / 50mm - 20 per box



Code	Colour	Width	
<b>THERM100YEL</b>	Yellow	100mm	10
<b>THERM100WHT</b>	White	100mm	10
<b>THERM100RED</b>	Red	100mm	10
<b>THERM100PRI</b>	Primrose	100mm	10
<b>THERM50YEL</b>	Yellow	50mm	20
<b>THERM50WHT</b>	White	50mm	20
<b>THERM50RED</b>	Red	50mm	20
<b>THERM50PRI</b>	Primrose	50mm	20

### Overbanding Tape

- 35mm x 5m
- Standard or HAPAS approved



Code		
<b>FORR35</b>	Standard	12
<b>FORR172</b>	HAPAS approved	12

### Anti Skid Sheets

**NEW**

- Quick and flexible solution to the repair of anti skid surfacing
- Easily cut to size
- 0.6m<sup>2</sup> per sheet (1m x 600mm)
- Pack of 5 sheets
- Available in blue, buff, green, grey and red



Code		
<b>THERMAS160</b>		5

## Colas RS Bitukold Spray

- 600ml spray
- Cold applied emulsion
- Rapid setting in cold and damp conditions



Code

CLBTK60



5

## Colas Bitumen Colspray

- 750ml spray
- Bitumen cold joint sealer and tack coat spray



Code

CLSPR75



5

## Colas Bitukold Standard

- 15kg tub
- Cold hand-applied bitumen emulsion
- Can be used in place of a tack coat



Code

CLBTK15



36

## Colas Leoclean

- 500ml trigger spray
- Cleaner and degreaser
- Removes bitumen, tar, asphalt, grease and carbon



Code

CLLCN50



5

## Bituseal Spray

- 750ml
- Fast curing - touch dry in 5 minutes
- Spray application - aerosol spray for quick and simple application
- Specially formulated - bonds best on vertical surfaces and joints



ENQUIRE FOR  
PALLET  
RATES

Code

BS75



12

## Cold Asphalt Road Repair

- 25kg bags
- Easy to use, instant solution to repairing potholes and roads
- Cold applied, permanent repair
- Use directly in any weather
- Instantly trafficable



Code

REP25BAG



1

STRING LINES & CHALK LINES

**MAX Professional Hi-Vis Stringline**

- Twisted nylon line
- Hi-Vis red



**BEST SELLER**



Code		
<b>BL100P</b>		12

**Professional Stringline**

- Twisted nylon line - white
- Price each



BL018P      BL030P

Code		
<b>BL018P</b>	18m	12
<b>BL030P</b>	30m	12

**Hi-Vis Stringline**

- 100m length
- Choice of three colours



Code		
<b>SL100G</b>	Green	10
<b>SL100P</b>	Pink	10
<b>SL100Y</b>	Yellow	10

**Line Pins**

- 6" length
- Pack of 12



Code		
<b>BLP150</b>		12

**MAX Aluminium Chalk Line**

- 30m / 100ft



Code		
<b>AL030</b>		12

**MAX Chalk Refill**

- 200gm (7oz)
- Choice of four colours



Code		
<b>CLRBL</b>	Blue	10
<b>CLRRD</b>	Red	10
<b>CLRWT</b>	White	10
<b>CLRYW</b>	Yellow	10

**Trade Chalk Line**

- 30m / 100ft



Code		
<b>CL030</b>		12



# DECORATING & SEALANTS



Paint Brushes	128
Rollers & Roller Trays	129
Decorating Accessories	130-131
Sandpaper & Adhesives	132
Sealant & Sealant Guns	133
Expanding Foam, Applicator Gun & Foam Cleaner	134

PAINT BRUSHES

Economy Paintbrush



Code		
PBE001	1"	12
PBE002	2"	12
PBE003	3"	12
PBE004	4"	12
PBE006	6"	12

MAX Professional Paintbrush



Code		
PBP001	1"	12
PBP002	2"	12
PBP003	3"	12
PBP004	4"	12

Masonry Wall Brush

- 4" (100m)
- Use on smooth or rough surface
- Hard wearing synthetic & natural bristle mix



Code		
PBW5		6

Premium Paint Brush Set - 3 Piece

- 25, 38 & 50mm
- Superior quality, thick pure bristle



Code		
PBPSET		12

Synthetic Brush Set - 5 Piece

- 19, 25, 38, 50 & 75mm (¾, 1, 1½, 2 & 3")
- 100% synthetic filaments



Code		
PBP005		10

ROLLERS & ROLLER TRAYS

Extension Pole

- Extends 1-2m



Code

RLEP02



10

Roller & Tray Set

- 9" Tray & frame
- 9" soft medium pile roller



Code

RLTC09



12

Premium Roller Sleeves

- 45mm core
- Medium (3/4) pile

RLS09



RLS12

Code

RLS09 9" 230mm

RLS12 12" 300mm



6

6

Premium Roller & Tray Set

- 9" tray & frame
- 2 x 9" simulated sheepskin roller sleeves
- Use on both smooth and rough surfaces



Code

FAIRKIT9



20

Mini Roller & Tray Set

- 100mm
- 1 x roller sleeve for gloss/varnish
- 1 x roller sleeve for emulsion

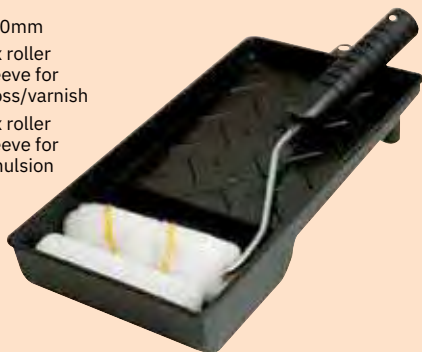

Code

RLT100



10

Mini Roller Sleeves

- Pack of 10
- 100mm
- Medium pile



Code

RLS100



10

DECORATING ACCESSORIES

Paint Scuttle Set

- 15 litre scuttle
- Set complete with wooden handle & 12" roller



Code

RLTC12



1

White Spirit

- Solvent designed for thinning paints & solvents
- Conforms to BS245



Code

WS2L 2 litre



8

WS4L 4 litre

4

Paint Kettle Plastic

- 1 Litre



Code

PAK01



12

Paintbuster Wipes

- Tub of 50
- Suitable for hands & hard surfaces
- Removes paints & inks
- Removes graffiti from non-porous surfaces



Code

JLPBUSTER



6

Mixing Paddle

- 10mm DIA hex shank
- 80mm head
- Max 600rpm
- To mix paint, plaster, cement etc.

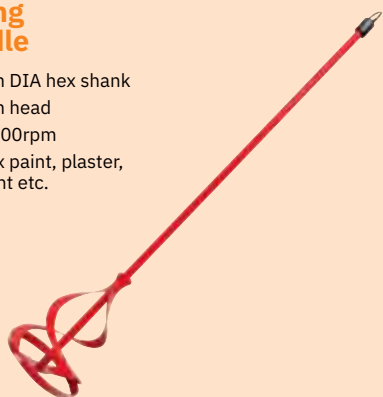

Code

MP10600



12

Heavy Duty Mixing Paddle

- 115 x 600mm head
- M14 thread shank
- 13mm (½") capacity chuck



Code

MP115M14



12

**Glass Scraper**

- Blade width 60mm
- Use with or without blade



Code	
<b>GSP</b>	10

**Long Handle Heavy Duty Scraper**

- Complete with 2 replacement blades
- 4" (100mm) blade



Code	
<b>SCRAHD4</b> Scraper	12
<b>SCRARB5</b> Replacement Blades (pk5)	6

**Premium Scraper**



Code	
<b>SCRA02</b> 2"	12
<b>SCRA03</b> 3"	12
<b>SCRA04</b> 4"	12

**Professional Scraper**



Code	
<b>SCRA03P</b> 3"	12
<b>SCRA04P</b> 4"	12

**Masking Tape**

- 25mm (1")
- 50mm (2")



Code	
<b>MT25</b> 25mm	36
<b>MT50</b> 50mm	24

**Dust Sheet**

- 3.6 x 2.7m (12 x 9')



Code	
<b>DS129</b>	12

## SANDPAPER & ADHESIVES

### Sandpaper Roll

- Industrial quality for long life & high performance
- Ideal for ½ sheet sanders, palm sanders or for hand use
- 10m x 115mm



Code		
SANDROLL-001	40 grit	1
SANDROLL-002	60 grit	1
SANDROLL-003	80 grit	1
SANDROLL-004	120 grit	1
SANDROLL-005	180 grit	1
SANDROLL-006	240 grit	1

### Sandpaper Discs

- 100 grit
- 225mm diameter
- Pack of 25

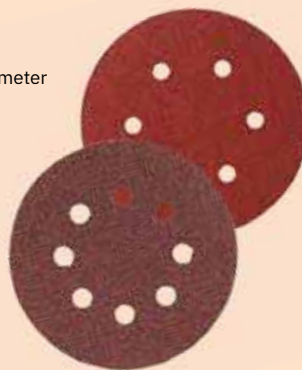

Code		
FLEXWSEP10025	P1	1

### Aerosol Spray Adhesive

- 500ml



Code		
HDA5		12

### Strong Grip

- 350ml



FROM ONLY  
**2.39**

Code		
NN310		12

### PVA Glue

- 5 litres
- White



Code		
PVA5L		4

## FOR OUR FULL SITE PROTECTION RANGE

HAVE YOU SEEN?

SEE PAGES  
175-180



### MAX General Purpose Silicone

- For use on porous surfaces
- Quick curing
- Permanently flexible
- Certified to EN15651



ENQUIRE FOR BULK RATES



Code		📦
<b>CS310</b>	Clear	25
<b>WS310</b>	White	25
<b>BLKS310</b>	Black	25

### Sealant Gun



Code		📦
<b>SEAL01</b>		24

### Decorators Caulk

- 1hr drying
- White



Code		📦
<b>FDDC310</b>		25

EXPANDING FOAM, APPLICATOR GUN & FOAM CLEANER

Expanding Foam

- Ideal for filling, sealing and insulation of joints and gaps in a variety of building, construction applications
- 750ml
- Fast drying
- Suitable for: PVCu, plastic, brick, stone, concrete, metals, timber



HF750



GF750

Code



HF750 Hand

12

GF750 Gun

12

Expanding Foam Fire Rated

- 750ml



HF750FR



GF750FR

Code



HF750FR Hand

12

GF750FR Gun

12

Foam Gun & Cleaner



GF100

FC500

Code



GF100 Gun

12

FC500 500ml Cleaner

12



# SITE EQUIPMENT



Oil & Lubricants	<b>136-137</b>
Fuel Containers & Accessories	<b>137-138</b>
Tonne Bags, Tarpaulins & Sand Bags	<b>139</b>
Protective Sheeting, Correx & Accessories	<b>140-141</b>
Trestles & Props	<b>141</b>
Rope, Scaffold & Rebar Caps & Cobra Rodding System	<b>142</b>
Cobra Rodding System	<b>142</b>
Tarmac Sheets, Hessian Roll & Shrink Wrap	<b>143</b>
Tapes	<b>144</b>
Barrier Tapes & Barriers	<b>145</b>
Ratchet Straps & Lifting Slings	<b>146</b>
Steel Strapping Equipment	<b>147</b>
Fencing Pins & Road Pins	<b>148</b>
Setting Out Pegs, Warning Tapes & Mesh Fencing	<b>149</b>
Hoses & Accessories	<b>150-151</b>
Drain Equipment	<b>152-154</b>
Site Security & Whistles	<b>155</b>
Padlocks & Security Chains	<b>156-157</b>
Secure Site Storage	<b>158-160</b>
Manual Handling	<b>160-161</b>
Matting	<b>162</b>

**OIL & LUBRICANTS**

**MAX 2 Stroke Oil (One Shot)**

**BEST SELLER**

- 2 Stroke oil in 100ml one shot bottles - use as a straight mix with 5 litres of petrol
- For all modern static 2 stroke engines
- Semi synthetic
- 50 in a box



Code



**OIL100ML**

50

**MAX 2 Stroke Oil**

- Semi synthetic
- 8 in a box
- 1 litre



Code



**OIL1LITRE**

8

**MAX High Quality Lubricant Spray**

- 400ml
- Cleans and lubricates, reducing friction and wear
- Protects from rust and moisture
- Suitable for use on metal, wood, rubber, vinyls & most plastics



Code



**MAX100**

12

**WD-40 Lubricant Spray**

- Multi use smart straw
- 300ml



Code



**WD40**

12

**All Purpose Silicone Spray**

- 400ml



Code



**SILSPRAY**

12

### Stihl 2 Stroke Oil (One Shot)

- Standard - 2 Stroke oil in 100ml one shot bottle
- Green HP Super - Easy to use, just add to 5 litres of fuel



OILSTIHL

OILSTIHLG

Code



<b>OILSTIHL</b>	Standard	10
<b>OILSTIHLG</b>	HP Super	10

### Husqvarna Oil Guard 2 Stroke Oil (One Shot)

- Easy to use, just add to 5 litres of fuel



Code



<b>OILHUSQ</b>		10
----------------	--	----

### Plastic Petrol Cans

- Available in red, green or black



FCPR05



FCPG05



FCPB05

Code



<b>FCPR05</b>	5 litre green	6
<b>FCPG05</b>	5 litre red	6
<b>FCPB05</b>	5 litre black	6

### Metal Petrol Cans

- 10 litres
- Available in red or green
- Explo-safe in yellow



FCSR10



FCSG10



FCAE10

Code



<b>FCSR10</b>	10 litre - red	8
<b>FCSG10</b>	10 litre - green	8
<b>FCAE10</b>	Explo-safe	8

**FUEL CONTAINERS & ACCESSORIES**

**Metal Jerricans**

- Available in red or green



Code		📦
<b>FCJ10-RED</b>	10 litre	4
<b>FCJ10-GRN</b>	10 litre	4
<b>FCJ20-RED</b>	20 litre	4
<b>FCJ20-GRN</b>	20 litre	4

**Plastic Funnel**

- 250 x 175mm
- Rectangular
- Filter included



Code		📦
<b>FNPL250</b>		10

**Spout for Jerrican**

- 20 litre only



Code		📦
<b>JC20S</b>		10

**PVC Funnel**

- 6" diameter
- Filter included



Code		📦
<b>FNPVC200</b>		12

**Heavy Duty Barrel Pump**



Code		📦
<b>BP120</b>		1

**Tonne Bag with Open Top**

- 1 tonne capacity
- 85 x 85 x 85cm
- Single use



**BEST SELLER**

Code 📦  
**TONB01** 10

**Tarpaulin Sheet**

- Eyelets round edges



Code 📦  
**TARP1218** 1.2 x 1.8m 12  
**TARP45** 3.5 x 5.4m 5  
**TARP117** 11 x 7m 3

**Green Skip Net**

- Mesh skip net to suit 8 yard skip
- 15 x 9'



Code 📦  
**SKIP08** 1

**Polypropylene Sandbags**

- 33 x 77cm
- Black or white



Code 📦  
**POLYBBLK** Black 50  
**POLYBWHT** White 50

**Hessian and Rot Proof Sandbags**

- 33 x 75cm (14 x 33")



Code 📦  
**HESSB** Hessian 50  
**HESSRT** Rot Proof 50

PROTECTIVE SHEETING & ACCESSORIES

Debris Netting

- 2 x 50m roll



Code



<b>DN200GRE</b>	Green	1
<b>DN200YEL</b>	Yellow	1
<b>DN200BLU</b>	Blue	1
<b>DN200RED</b>	Red	1
<b>DN200ORA</b>	Orange	1

Monarflex Sheeting

- 2 x 45m
- Personalised branding available



MNFFR245



Code



<b>MNF245</b>	Standard	1
<b>MNFFR245</b>	Fire retardant	1

Monarflex Toggles

- Elastic bungee toggle
- Secure sheeting to scaffold structures



Code



<b>MNFTG</b>	100
--------------	-----

DPM Black Polythene Sheeting

- 4 x 25m (100m<sup>2</sup>)
- High quality recycled polyethylene

CALL FOR CURRENT BEST RATES



Code



<b>DPM1000</b>	1000 gauge / 250MU	40
<b>DPM1200</b>	1200 gauge / 300MU	40

**Correx Sheeting - Standard**

- 2.5 x 1.2m
- Branding available
- Standard correx
- Black



Code **CRXST** 500

**Correx Sheeting - Flame Retardant**

- 2.5 x 1.2m
- Branding available
- Flame retardant
- White



Code **CRXFR** 500

**Dust Sheet**

- 3.6 x 2.7m (12 x 9')



Code **DS129** 5

**FOR OUR FULL RANGE OF SITE PROTECTION**



SEE PAGES 175-180



**Builders' Trestles**

- Adjustable steel trestles
- Designed for use with four standard boards
- Complies with BS1139 Part 4:1982 (1990)
- Size 2: 760-1170mm (BT/24/PT)
- Size 3: 1070-1680mm (BT/34/PT)



Code

<b>BT24</b>	Size 2	1
<b>BT34</b>	Size 3	1

**Adjustable Steel Props**

- Manufactured to BS4074:1984
- Size 1: 1753-3124mm (ACRO1)
- Size 2: 1981-3352mm (ACRO2)



Code

<b>ACRO1</b>	Size 1	1
<b>ACRO2</b>	Size 2	1

ROPE, SCAFFOLD & REBAR CAPS & COBRA RODDING SYSTEM

Polypropylene Rope

- Made from strong blue polypropylene
- Meets the needs of all trades
- Larger sizes on drum reel



Code		
<b>ROPE22006</b>	6mm x 220m	10
<b>ROPE50006</b>	6mm x 500m	1
<b>ROPE22010</b>	10mm x 220m	1
<b>ROPE22012</b>	12mm x 220m	1

Scaffold Tube End Cap

- Pack of 200



Code	
<b>SCAF001YEL</b>	1

Scaffold Nipple Caps

- Box of 1000



Code	
<b>SCAF002YEL</b>	1

Cobra Rodding System

- Other sizes available on request



Code		
<b>COBFF06100</b>	Ferret frame 6mm x 100m	1
<b>COBCF09100</b>	Compact frame 9mm x 100m	1
<b>COBLF09100</b>	Large frame 9mm x 100m	1
<b>COBLF11100</b>	Large frame 11mm x 100m	1

Mushroom Caps

- Small 6 - 16mm
- Large 16 - 32mm
- Pack of 250



Code		
<b>MUSHS</b>	Small	40
<b>MUSHL</b>	Large	40



**Tarmac Sheet**

- Waxed jute material
- With ropes & eyelets



Code		
<b>TS1209</b>	12 x 9'	1
<b>TS1509</b>	15 x 9'	1
<b>TS1812</b>	18 x 12'	1
<b>TS2418</b>	24 x 18'	1

**Quilted Tarmac Sheet**

- 610gm PVC top
- 14oz jute bottom
- With ropes & eyelets



Code		
<b>TSQ1209</b>	12 x 9'	1
<b>TSQ1509</b>	15 x 9'	1
<b>TSQ1812</b>	18 x 12'	1

**Hessian Roll**

- 1.37m x 46m
- 100% natural & biodegradable



Code		
<b>HESROLL</b>		1

**Bubble Wrap - Small Bubble**

- 1200mm x 100m



Code		
<b>BWSB12100</b>		1

**Black Shrink Wrap Industrial**

- 500mm x 250m
- 25MU gauge



Code		
<b>BSW10</b>		6

**Clear Shrink Wrap**

- 400mm x 250m
- 20MU gauge



Code		
<b>CSW10</b>		6

TAPES

Gaffa Tape

- 50m



Code		
<b>GAFBLA</b>	Black 50mm	24
<b>GAFSIL</b>	Silver 50mm	24
<b>GAFBLA75</b>	Black 75mm	26
<b>GAFSIL75</b>	Silver 75mm	24
<b>GAFBLA100</b>	Black 100mm	12

Masking Tape

- 25mm (1")
- 50mm (2")



Code		
<b>MT25</b>	25mm	36
<b>MT50</b>	50mm	24

Low Tack Protection Tape

- 50mm x 33m



Code		
<b>LTP50-BK</b>	Black	24
<b>LTP50-WHT</b>	White	24

Insulation Tape

- 19mm x 33m



Code		
<b>IN-WHT</b>	White	10
<b>IN-BLU</b>	Blue	10
<b>IN-GRE</b>	Green	10
<b>IN-BLA</b>	Black	10
<b>IN-RED</b>	Red	10
<b>IN-YEL</b>	Yellow	10
<b>IN-GRE/YEL</b>	Green / Yellow	10

Double Sided Tape - Black

- 50mm x 10m



Code		
<b>DSTBLK50</b>		24

Silver Foil Tape

- **SFT50** 50mm x 45m
- **SFT100** 100mm x 45m

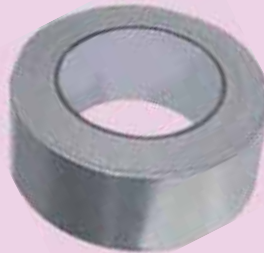

Code		
<b>SFT50</b>		24
<b>SFT100</b>		24

PTFE Tape

- 12mm x 12m



Code		
<b>PTFE1212</b>		10

BARRIER TAPES & BARRIERS

JSP Warning Chain

- 8mm plastic chain
- 25m pack in red / white



Code  4  
**PC258**

Pendant Bunting Tape Red & White

- 26m
- 32 red / white markers



Code  1  
**BUNTRW26**

Orange Skipper Unit

- Unique way to cordon off an area
- Fits on a road cone
- Contains 9m retractable tape



Code  15

<b>SKIPPER01</b>	Black/yellow	15
<b>SKIPPER02</b>	Red/white	15

Self Adhesive Barrier Tape

- 50mm x 33m

HZA-BY

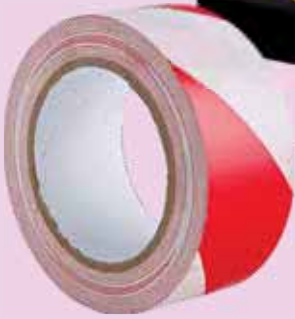
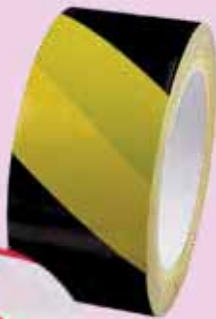

HZA-RW

Code  24

<b>HZA-BY</b>	Black & Yellow	24
<b>HZA-RW</b>	Red & White	24

Zebra Barrier Tape

- Width 70mm
- Non-adhesive



HZT-RW100

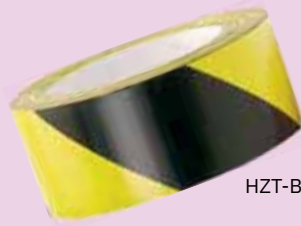

HZT-BY

Code  18

<b>HZTRW100</b>	Red & White	100m	18
<b>HZTRW500</b>	Red & White	500m	10
<b>HZTBY100</b>	Black & Yellow	100m	18
<b>HZTGW500</b>	Green & White	500m	10

## RATCHET STRAPS & LIFTING SLINGS

### Ratchet Straps

- Supplied with test information & serial number sewn into strap

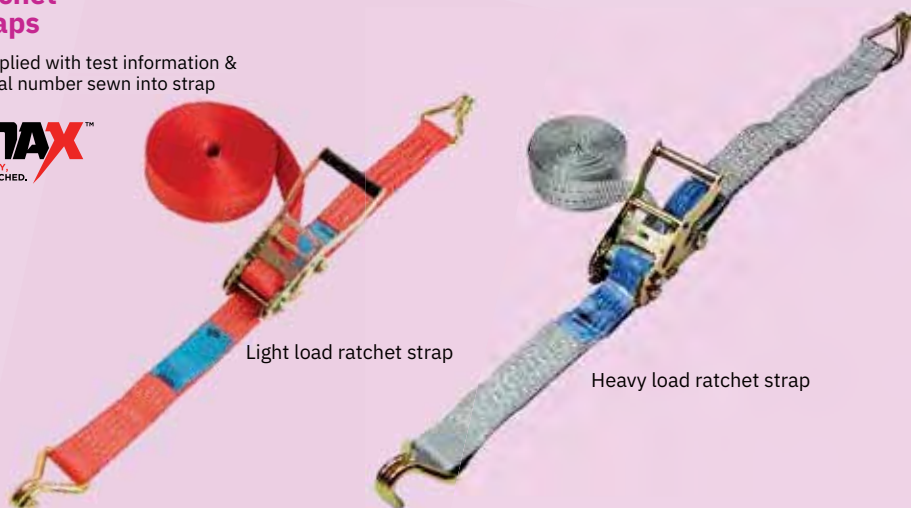

Code			
<b>RACH4L</b>	2 tonnes	Light load - 4m	6
<b>RACH4H</b>	4 tonnes	Heavy load - 4m	6
<b>RACH6H</b>	4 tonnes	Heavy load - 6m	6
<b>RACH8H</b>	4 tonnes	Heavy load - 8m	6
<b>RACH10H</b>	4 tonnes	Heavy load - 10m	6
<b>RACH12H</b>	4 tonnes	Heavy load - 12m	6

### Lifting Straps

- Supplied with test information & serial number sewn into strap



Code			
<b>LIFT012</b>	1 tonne	1m x 44mm	10
<b>LIFT001</b>	1 tonne	3m x 35mm	10
<b>LIFT009</b>	2 tonnes	2m x 60mm	10
<b>LIFT002</b>	2 tonnes	3m x 60mm	10
<b>LIFT003</b>	2 tonnes	4m x 60mm	10
<b>LIFT004</b>	2 tonnes	6m x 60mm	10
<b>LIFT005</b>	3 tonnes	3m x 90mm	10
<b>LIFT006</b>	3 tonnes	4m x 90mm	10
<b>LIFT010</b>	3 tonnes	6m x 60mm	10
<b>LIFT007</b>	4 tonnes	4m x 120mm	10
<b>LIFT008</b>	4 tonnes	6m x 120mm	10

### Steel Strapping Kit

Kit includes:

- Strapping, steel, ribbon wound, 19 x 0.5mm black
- Mobile dispenser for ribbon wound steel strapping
- Safeguard Snap-on seals, 19mm
- Tensioner for steel strapping
- Sealer for 19mm steel strapping



Code

TSSK19



1

### Strapping Combination Tool

- For 19mm strapping
- A unique tool for clamping and tensioning steel strapping without the need for banding clips



Code

CTTLN19



1

### Strapping Seals

- 19mm steel
- Packs of 1000



Code

SSEAL19



1

### Steel Strapping

- 19mm width
- 330m long



ENQUIRE FOR PALLET RATES

Code

SB19



1

## FENCING PINS & ROAD PINS

### Non-Conductive Fencing Pin

- 1270mm
- Lightweight for easy transportation & storage



Code

RSIFP11



500

### Orange Non-Conductive Fencing Pin

- 100% non-conductive to promote safety on site
- 1270mm
- High visibility



Code

RSIFP11-ORA



200

### Non-Penetrating Steel Fencing Pin

- More durable than plastic alternatives
- 1350mm
- Held down with sandbags (see Page 139)



Code

RSFP13NP



10

### Steel Fencing Pin

- Round pin (smooth bar)
- Standard: 1370mm  
- Price per 10 pack
- Extra thick: 1370mm  
- pack of 5, price each

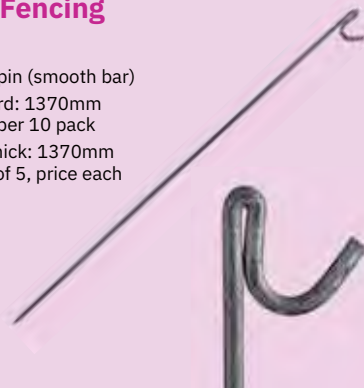

Code

RSFP11/10 Standard - 10 pack



50

RSFP14 Extra thick - each

10

### Steel Road Pin

- 6 different styles available
- Round pin (smooth bar)

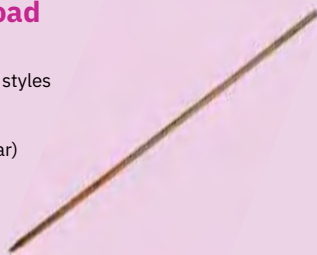

Code

RSRP600 17 x 600mm



10

RSRP900 17 x 900mm

10

RSRP1200 17 x 1200mm

10

RSRP900/20 20 x 900mm

10

RSRP1200/20 20 x 1200mm

10

RSRP900/BASE Road Pin with a base

10

### Non-Conductive Road Pin

- 100% non-conductive
- 900mm



Code

RSRP900INS



10

## Underground Warning Tape

- 365m
- Provides visual warning of buried cables & pipes



Code		
<b>HZ-ELEC</b>	Electricity	4
<b>HZ-FIBR</b>	Fibre optic	4
<b>HZ-STRE</b>	Street lighting	4
<b>HZ-TELE</b>	Telephone	4
<b>HZ-GAS</b>	Gas	4
<b>HZ-WATR</b>	Water pipe	4
<b>HZ-TS</b>	Traffic signals	4
<b>HZ-SEWR</b>	Sewer	4

## Mesh Fencing

- 1m height x 50m length
- Four different colours available



Code		
<b>RSMFO</b>	Orange	1
<b>RSMFB</b>	Blue	1
<b>RSMFG</b>	Green	1
<b>RSMFY</b>	Yellow	1

## Detectable Underground Mesh Warning Tape

- Plastic mesh tape with stainless steel wire for providing a detectable warning of non-metallic services below
- 100m length

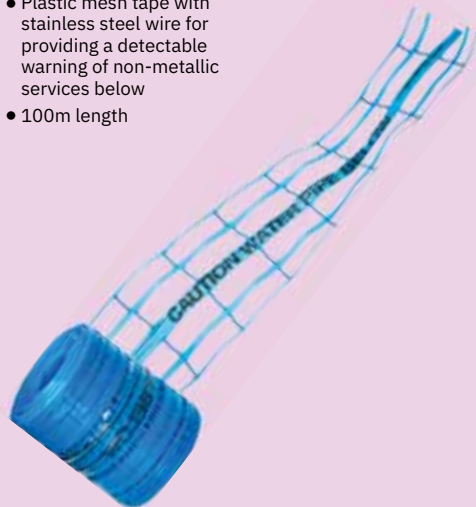

Code		
<b>HZDM-DATA</b>	Fibre optic cable below	1
<b>HZDM-ELEC</b>	Electric cable below	1
<b>HZDM-GAS</b>	Gas pipe below	1
<b>HZDM-WATR</b>	Water pipe below	1

## Setting Out Pegs & Profile Boards



Code		
<b>SOPEG01</b>	50 x 50 x 600mm	25
<b>SOPEG09</b>	50 x 50 x 900mm	25
<b>SOPEG02</b>	50 x 50 x 1200mm	25
<b>SOPEG03</b>	50 x 50 x 1500mm	25
<b>PROFB</b>	Profile boards 3' x 3' x 1/2"	25

**HOSES & ACCESSORIES**

**Reinforced Contractor Hose**

- 12mm (½") diameter
- 30m length



Code

**HOSP30**



1

**Green Garden Hose c/w Fittings**

- 12mm (½") diameter
- 30m
- Fittings as shown in image



Code

**HOSG30**



1

**Pro Line Standpipe Hose**

- 19mm (¾") diameter
- 25m length



Code

**H097696**



1

**50m Green Garden Hose**

- 12mm (½") diameter
- 50m
- Fittings not included



Code

**HOSG50**



1

**Compressor Hose with Fittings**

- 15m length
- 300psi
- Compatible with HOSAIR04



Code

**HOSAIR**



1

**Safety Whipcheck**

- ½" cable
- Suitable for ½" - 1¼" hose
- 970mm (38") length



Code

**HOSAIR04**



10



### Adjustable Hand Sprayer Gun

- To suit 12mm (½") diameter hose



Code

AHG01



5

### Tap Connector

- To suit 12mm (½") diameter hose



Code

HOSA06



12

### 2 Way & 3 Way Connector

- To suit 12mm (½") diameter hose



HOSA07

HOSA08

Code

HOSA07 2 way

HOSA08 3 way



12

12

### Hose Repair Connector

- To suit 12mm (½") diameter hose



Code

HOSA09



12

### Water Stop Hose Connector

- To suit 12mm (½") diameter hose



Code

HOSA05



12

### Hose Clips



Code

HOSCLIP22 14 - 22mm

HOSCLIP25 17 - 25mm

HOSCLIP35 25 - 35mm

HOSCLIP45 35 - 45mm

HOSCLIP60 45 - 60mm



10

10

10

10

10

**DRAIN EQUIPMENT**

**Universal Drain Rod Set**

- Includes double worm screw and plunger
- 10no 92cm rods
- 1no 10cm rubber plunger
- 1no 5cm double worm screw



Code

**DR12P**



1

**Drain Plunger Full Circle**



Code

**DR4FM**

4"



1

**DR6FM**

6"

1

**Drain Plunger Half Circle**



Code

**DR4HM**

4"



1

**DR6HM**

6"

1

**Drain Double Worm Screw**



Code

**DRDWS**



12

**3/4 Drain Rods**



Code

**DR11311**



10

**Drain Brush**

- Easy to use, just add to 5 litres of fuel



Code

**DRB04**

4"



1

**DRB06**

6"

1

**Drain Test Dye**

- 200g



Code

**DR79211**

Green



1

**DR79191**

Red

1

### Drain Stopper

- Fitted with removable top caps and rubber rings



Code		📦
<b>DS050</b>	50mm	1
<b>DS075</b>	75mm	1
<b>DS100</b>	100mm	1
<b>DS125</b>	125mm	1
<b>DS150</b>	150mm	1
<b>DS200</b>	200mm	1
<b>DS225</b>	225mm	1
<b>DS250</b>	250mm	1
<b>DS300</b>	300mm	1
<b>DS350</b>	350mm	1
<b>DS450</b>	450mm	1

### Drain Stopper Nipples



Code		📦
<b>DSN12B</b>	½": plugs 40-150mm (1½")	10
<b>DSN1B</b>	1": plugs 175-450mm (7-18")	10
<b>DSN2B</b>	2": multilock/ large plugs 17"+	10

### Brass Replacement Stopper End Cap



Code		📦
<b>DSEC1B</b>	1"	1
<b>DSEC12B</b>	½"	1

### Canvas Air Bag Stoppers

- 1.2m hose
- 3m hose available to order - please enquire
- Brass valve fitting



Code		📦
<b>DR81031</b>	100mm (4")	1
<b>DR81051</b>	150mm (6")	1
<b>DR81081</b>	225mm (9")	1
<b>DR81121</b>	300mm (12")	1

### PVC Air Bag Stoppers



Code		📦
<b>PVCAIRBAG100</b>		1
<b>PVCAIRBAG150</b>		1

**DRAIN EQUIPMENT**

**Manhole Keys**

- Pack of 2



Code		
<b>MK001</b>	Manhole key	1
<b>MK002</b>	6" D handle	1
<b>MK003</b>	12" D handle	1
<b>MK004</b>	18" D handle	1

**Drain Clearing Wheel**

- Guide rods around difficult bends
- Remove minor blockages



Code		
<b>DRCW1</b>		1

**Drain Test Kit**



Code		
<b>DRAINTEST</b>		12

**Drain Test Rubber Hose**

- Cut to size - please confirm how many metres you require when ordering
- Price per metre



Code		
<b>DTRTPM</b>		1

**Inflator Pumps**

82011



84011

Code		
<b>DR82011</b>		1
<b>DR84011</b>		1

**Standpipe Single Head**

- With non-return valve



Code		
<b>SP100</b>		1

**Standpipe Key**

- 1 ¼" AF fitting
- 16mm diameter bar



Code		
<b>SPKEY</b>		1

**Stopcock Key**

- 42" length
- 16mm diameter bar



Code		
<b>FRSCK01</b>		1

**Key Cabinet**

- Keep large numbers of keys organised, safe and secure



KEYC048



KEYC096

Code		
<b>KEYC048</b>	48 hooks	1
<b>KEYC096</b>	80 hooks	1

**Plastic Key Tags**

- Pack of 100



Code		
<b>KEYT48</b>		10

**Digital Keypad Lock**

- Satin chrome



Code		
<b>DIGKEY</b>		10

**Hasp & Staple - Zinc Plated**

- 150mm
- Staple hole size 12mm
- Fixings not included



Code		
<b>FAIPHS150</b>		12

**Hand Squeeze Whistle**

- Soft PVC
- Assorted colours



Code		
<b>WHISTLEPVCHYG</b>		12

**Fox 40 Electronic Whistle**

- 3 distinctive tones at 125db
- Includes wrist lanyard & 9v battery



Code		
<b>ELEC-WHISTLE</b>		1

**PADLOCKS**

**Brass Padlock**

- Brass body
- Hardened steel shackle
- Complete with 2 keys



PDLLS50

Code		
<b>PDLB30</b>	30mm	6
<b>PDLB40</b>	40mm	6
<b>PDLB50</b>	50mm	6
<b>PDLB60</b>	60mm	6
<b>PDLLS50</b>	50mm	6

**Squire High Security Padlock - Combination**

- Squire CP40
- Combination padlock - 4 digit
- 63mm



Code		
<b>HSQCP4025</b>		12

**ABUS 65/50mm Padlock Keyed Alike**

- Solid brass padlock
- Keyed alike - key suits all padlocks



Code		
<b>ABUKA03906</b>		6

**ABUS Combination Padlock**

- 30mm
- Combination padlock
- 3 digit
- Brass construction



Code		
<b>HS9LC</b>		12

### High Security Padlock

- Strengthened steel shackle
- Unique locking mechanism
- High security
- 5 keys included



**BEST SELLER**

COMES WITH **5 KEYS**



Code  **PDLHS** 6

### 70mm Discus Padlock

- 70mm case width
- 9.5mm shackle diameter
- 17mm shackle clearance



Code  **PDLD70** 6

### 8mm Galvanised Security Chain

- 8mm welded chain
- Cut to size - specify length (max. 10m)
- Maxload 450kg
- Tested but not certified - not for lifting or load binding



Code  **CHAINPM8** 10

### Plastic Sleeved Chain

- High tensile 10mm security chain
- Thermoplastic cover to protect equipment from chain



Code  **CHAIN10X1** 10mm x 1m 10  
**CHAIN10X2** 10mm x 2m 10

## forma-stor COSHH™

- » modular
- » quick
- » secure



see  
forma-stor  
in action

## save time, money and space

Increase productivity levels with our quick-assembly  
Forma-Stor range for on-site secure storage.



**4**  
SIZES  
AVAILABLE

**10 MIN**  
AVERAGE  
BUILD TIME

**FLAT-PACKED**  
FOR EASY  
TRANSPORTATION  
AND STORAGE

## forma-stor™





Storage Vault

- Heavy duty steel van storage vaults
- Powerful gas strut to ensure the ease of opening & closing the lid
- Supplied with heavy duty keys, that won't snap easily & can be removed from the lock when it is in the unlocked position
- Serial numbered for extra security & for guaranteed key replacement service



SECOX1



SECOX3



SECOX2



SECOX6



Code



<b>SECOX1</b>	59kg	915 x 490 x 450mm	1
<b>SECOX2</b>	98kg	1215 x 490 x 450mm	1
<b>SECOX3</b>	129kg	1200 x 665 x 630mm	1
<b>SECOX4</b>	130kg	1210 x 640 x 1175mm	1
<b>SECOX6</b>	138kg	1800 x 555 x 445mm	1

Flambank Hazardous Storage Box & Chest

- 30 minute fire resistance
- Compliant with regulations
- More sizes available



SECFBC4



SECFB2



Code



<b>SECFB2</b>	1275 x 665 x 660mm	1
<b>SECFBC4</b>	1275 x 675 x 1270mm	1
<b>SECCAS</b>	6" Castor wheels	1

6" Castors

- 6" castors to suit SECOX3, SECOX4, SECFB2, SECFBC4
- 2 x fixed & 2 x braked swivel



Code



<b>SECCAS</b>	1
---------------	---

SECURE SITE STORAGE & MANUAL HANDLING

**Beam Kart**

- Simple and effective method of moving beams
- Robust and durable for heavy site usage
- Puncture proof solid rubber tyres
- 500kg load capacity



BK1

BK2



Code

<b>BK1</b>	Upright sides	1
<b>BK2</b>	No upright sides	1

**Sack Truck**

- Very sturdy - built to last
- Double strength weld joints
- Up to 500kg load capacity



ST150

ST250

ST500

Code

<b>ST150</b>	Load Capacity 150kg	1
<b>ST250</b>	Load Capacity 250kg	1
<b>ST500</b>	Load Capacity 500kg	1

**Transbank Hazardous Transit Box & chest**

- Designed specifically for storing or transporting smaller quantities of flammables or chemicals
- Fully complies with all regulations
- 30 minute fire resistance



TRB4

TRB6



Code

<b>TRB4</b>	28kg Box 880 x 485 x 540mm	1
<b>TRB6</b>	38kg Chest 1195 x 485 x 540mm	1

**Gorilla Gas Cage**

- Modular, bolt together gas cage
- Galvanised for maximum durability



GGC4

GGC6

GGC9



Code

<b>GGC4</b>	68kg 1200 x 1200 x 1200mm	1
<b>GGC6</b>	87kg 1200 x 1200 x 1800mm	1
<b>GGC9</b>	135kg 1800 x 1800 x 1800mm	1

### Rubble Truck

- Cleverly designed tipping feature
- 400 litre / 750kg capacity scoop
- Strong crane lift eyes
- Solid rubber or pneumatic tyres
- Stackable
- Also available with lid



Code

**RT400** Solid rubber tyres

**RT400P** Pneumatic tyres



1

1

### Barro Box

- Unique secure yet portable design
- Mobile to static in seconds using the wheel winder lever
- Robust construction



Code

**BB2** 740 x 1095 x 720mm



1

### Turntable Truck

- Puncture proof solid rubber tyres
- Raised deck
- 1000kg load capacity
- 760 x 1820 x 455mm



Code

**TT100** Load capacity 1000kg



1

**MATTING**

**Heavy Duty Cellular Matting**

- 1m x 1.5m x 22mm
- Moulded anti-slip cellular structure
- Provides safety and traction on steep surfaces
- Easy clean
- Quick installation

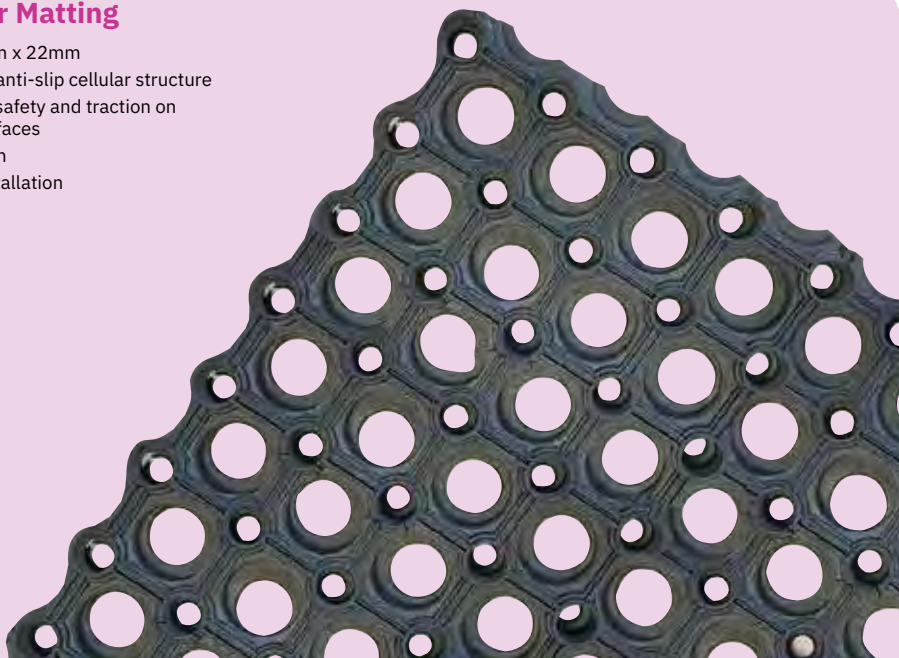

Code

**RMCB22**



60

**Hi Vis Rubber Matting**

- 1m x 10m long roll
- Excellent anti-slip properties
- Tough and durable
- VOC compliant
- Complies to EW649



Code

**RMHV10**



30

**Black Rubber Matting**

- 1.5m x 10m x 3mm
- Excellent anti-slip properties

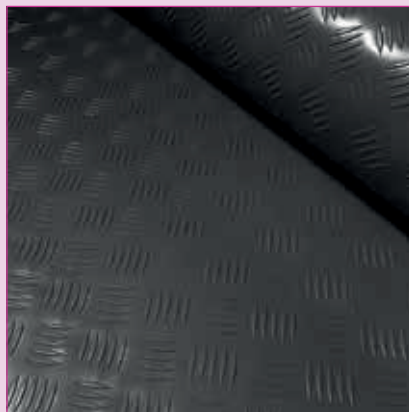

Code

**RMB3**



15

# ELECTRICAL & LIGHTING



Extension Leads	164-165
110v Transformers	165
Torches	166
LED Lighting	167
Site Lighting & Cable Management	168-171
Fans & Heaters	172-173
Batteries	174

## EXTENSION LEADS

### Extension Leads

- 240v



Code		
<b>EL24W41</b>	1m 4 way	10
<b>EL24W45</b>	5m 4 way	10
<b>EL24W62</b>	2m 6 way	10

### Various Fly Leads



Code		
<b>E85301</b>	13A / 16A 240v fly lead	1
<b>E85302</b>	16A / 13A 240v 2 gang fly lead	1
<b>E85300</b>	16A / 13A 240v 1 gang fly lead	1
<b>E85315</b>	16A / 13A 240v 4 gang fly lead	1
<b>E85323</b>	32A / 16A 110v fly lead	1
<b>E884309</b>	16A / 13A 240v adaptor	1

### Cable Reel Open 240v

- 240v
- 4 way



Code		
<b>EL225</b>	25m	1
<b>EL250</b>	50m	1

### Cable Reel Open 110v

- 110v
- 2 way
- 16 amp outlets



Code		
<b>EL125</b>	25m	1
<b>EL150</b>	50m	1

### 240v 25m 16A Blue Cable Reel

- 2 way
- 16 amp outlets
- 25m of cable



Code		
<b>EL24016A25</b>		1

### 240v 50m 16A Blue Cable Reel

- 2 way
- 16 amp outlets
- 50m of cable



Code		
<b>EL24016A50</b>		1

## Extension Lead 110v

- 14m length
- Fitted with plug & socket



Code		
<b>EL114116</b>	1.5mm x 14m 16amp	1
<b>EL114216</b>	2.5mm x 14m 16amp	1
<b>EL114132</b>	4.0mm x 14m 32amp	2

## Male & Female plug

- 110v

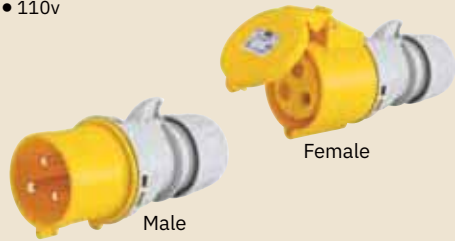

Male

Female

Code		
<b>ELS11016</b>	Female 16amp	1
<b>ELS11032</b>	Female 32amp	1
<b>ELP11016</b>	Male 16amp	1
<b>ELP11032</b>	Male 32amp	1

## 110v Transformer

- 3 K.V.A = 2 x 16 amp outlets
- 5 K.V.A = 2 x 16 amp & 1 x 32 amp outlets



ET500

ET300

Code		
<b>ET300</b>	3 K.V.A	1
<b>ET500</b>	5 K.V.A	1

## 4 Way Splitter Box

- 110v
- 5m cable



Code		
<b>EL14W16</b>	16amp	1
<b>EL14W32</b>	32amp	1

## 10 K.V.A Transformer

- Single phase
- 230/240v to 110v
- 4 x 16A outlets
- 2 x 32A outlets



Code		
<b>ET1000</b>	10 K.V.A	1

## BATTERIES FOR OUR RANGE OF BATTERIES GO TO PAGE 174



## TORCHES

**Rechargeable Torch**

- Complete with battery & charger
- 4 hours battery life
- 150 Lumens



Code

**LRT**

5

**Battery Torch**

- Complete with 6v battery
- 120 Lumens
- Water & impact resistant
- 12 hours run time



Code

**ET4L**

5

**2 Cell Rubber Torch**

- 2 x AA batteries (are included)
- 3 hours battery life
- 8 Lumens



Code

**ET2C**

5

**LED Lens i7 Flashlight**

- Supplied with roll protection ring, pouch, wrist strap & 4 x AAA batteries
- Advanced focus system
- 220 Lumens (high), 25 Lumens (low)
- Water resistant



Code

**LEDI7**

1

**H3 Battery Powered LED Head Torch**

- 60 lumens
- 3 x AAA batteries (Included)
- Integrated dimmer switch
- Burn time - up to 62hrs
- Swivel head



Code

**LED1041TP**

1

**30 LED Super Power Headlight**

- 80 lumens
- Variable light patterns
- Adjustable head
- Water resistant
- Batteries included



Code

**LHHEAD120**

1

**LED Rechargeable Head Torch**

- 300 lumens
- Rechargeable via mains or USB
- Can run on 3 x AAA batteries (included)
- Run time up to 60 hours
- Water & dust resistant
- Lamp head pivots within 90° angle for directional light



Code

**LED7298**

1

**LED Rubber Head Torch**

- 40 lumens
- 3 light modes - low, high & pulse
- 3 x AAA batteries (are included)
- 10 hour battery life



Code

**LEDRHT**

1



### MAX10 LED Light

- High power LED
- 10W
- 900 Lumens
- 110v



Code



MAXLED10

1

### MAX20 LED Flood Light

- High power LED
- 20W
- Rear mounted socket
- 110v



Code



MAXLED20

1

### LED Festoon Lighting

- 110V
- Ultra low wattage consumption at 2.5w per module
- Injection moulded fittings & Solid State lamp components take heavy knocks
- 2m spacing between light fittings
- Sonic sealing technology to give IP44 rating



Code

Length

Fittings



LTFLED25

25m

10

1

FLKLED50

50m

25

1

### LED Floodlight 110v

- High power LED
- 50w
- Also available in 240v
- Slim, fold flat design



Code



ELLEDFLD 110V

5

## SITE LIGHTING

## Low Energy Floodlight

- 38w
- Supplied complete with bulb



Code



<b>LTPRO-110</b>	110v light	6
<b>LTPRO-240</b>	240v light	6
<b>LTPROB</b>	Replacement bulb	1

## Halogen Floodlight

- 400w
- 110v
- Supplied complete with bulb



Code



<b>ELHLF01</b>	Light	8
<b>ELB500</b>	Halogen 500w bulb	10

## Festoon Lighting Kit

- Complete with bulbs
- Replacement bulbs ELB160B (each) see page 169
- 110v
- 25m - 20 Fittings
- 50m - 40 Fittings

BEST  
SELLER

Code



<b>LTF50</b>	50m kit	1
<b>LTF50</b>	50m kit	1

## Light Bulbs

- 110v
- BC & ES
- Fittings available

BC type



ES type

Code		
<b>ELB160B</b>	110v - 60w BC	100
<b>ELB160E</b>	110v - 60w ES	100
<b>ELB500</b>	Halogen 500w	100

## Cable Ties

- Pack of 100
- Black or yellow



Code			
<b>CABT200</b>	4.8 x 200mm	Black	1
<b>CABT300</b>	3.6 x 300mm	Black	1
<b>CABT400</b>	4.8 x 430mm	Black	1
<b>CABT580</b>	12.7 x 580mm	Black	1
<b>CABT710</b>	9 x 710mm	Black	1
<b>CABT200YEL</b>	4.8 x 200mm	Yellow	1
<b>CABT300YEL</b>	4.8 x 300mm	Yellow	1
<b>CABT400YEL</b>	4.8 x 400mm	Yellow	1
<b>CABT430YEL</b>	9 x 430mm	Yellow	1
<b>CABT530YEL</b>	9 x 530mm	Yellow	1
<b>CABT780YEL</b>	9 x 780mm	Yellow	1

## Cable Management Hooks

- Pack of 10



Code		
<b>CMH010</b>		5

## Extendable Tower Stand

- Effective management of trailing cables on site
- Extends up to 3m
- Carries multiple cables



Code		
<b>SKYHKSTND</b>		1

## SITE LIGHTING

### Halogen Tripod Worklight

- Adjustable stand 0.8m - 2m
- 500w - 1000w output
- Suitable for indoor & outdoor use
- Bulbs included
- Replacement bulb ELB500
- Protective grill glass guard
- 1 Gang 110v sockets



Code



LTHAL01 Single head

1

LTHAL02 Twin head

1

ELB500 Halogen 500w bulb

10

### Fluorescent Tripod Worklight

- Bulbs included
- 5m cable & plug
- Replacement bulb LTF21102
- 2ft bulb
- 2 Gang 16A 110v socket



Code



LTF2FT

1

### LED Tripod Lights

- Free standing
- LEDAL1 - Single head
- LEDAL2 - Double head



Code



LEDAL1 Single head

1

LEDAL2 Double head

1

### LED Uplight - 110v

- Free standing, detachable tripod base
- 1 Gang 110v socket
- 4' tall (1.2m)
- Low energy
- Impact resistant

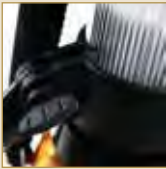

Code



E712673

2

### LED A-Frame Floorlight

- Free standing
- 110v
- 2 Gang 110v socket



Code



CL2FTLED

1

### Fluorescent Tubes

- White
- 110v, 50hz



Code



LTFT1102 2ft 18w

25

LTFT1104 4ft 36w

25

LTFT1105 5ft 58w

25

### Uplight V3

- Impact resistant polycarbonate lens
- Easy lamp replacement
- Anti-slip sand filled base
- 54w
- 4 Gang 16A 110v socket



Code



ELUPL54 Light & base

1

ELUPSS4 Stick only

1

## FANS AND HEATERS

### Convactor Heater

- 2kw
- 230v office convactor heater
- 110v site convactor heater
- Adjustable heat settings



Code



ELOFH01 230V

1

ELOFH03 110V

1

### Oil Filled Radiator

- 2kw
- 240v
- Adjustable heat settings



Code



SOFR20 Without timer

1

SOFR20T With timer

1

### Office Fan Heater

- 2kw
- 240v
- Adjustable heat settings



Code



SFHF20

1

### Rhino Infrared Heater

- 110v or 240v
- A powerful short wave infrared heater
- Provides instant heat at the flick of a switch by heating up objects directly and not the atmosphere
- Contains twin 1400w infrared elements and lockable wheels for total portability and safety
- Ideal for temporary heating and for drying paintwork and plaster
- Plastic body resists dents and scrapes



Code		
<b>H029300</b>	110v	1
<b>H029400</b>	240v	1

### Portable Air Conditioning Unit

- 240v
- 2600w
- 3 in 1 - Cooling, Dehumidifier and Fan
- Ideal for rooms with an area of 18-22m2
- 3 speed fan for maximum control
- Auto swing function
- Digital soft-touch controls with LED display
- Programmable timer
- Handles and castors for easy movement
- Low noise (56dB)
- Dehumidifier - 0.9 L/h
- Fan - 360 m3/h Exhaust hose with adapter
- Window sealing plate assembly
- Remote control with 2 AAA batteries



Code		
<b>EH1806</b>	9000 BTU	1
<b>H03622</b>	12000 BTU	1

### Office Fan Heater

- 2kw
- 240v
- Adjustable heat settings



Code	
<b>ELOFH02</b>	1

### Desk Fan

- 12"
- 240v
- 3 fan speeds
- 80° oscillation
- 25° tilt



Code	
<b>ELFAN01</b>	1

### Floor Standing Fan

- 16"
- 240v
- 3 fan speeds



Code	
<b>ELFANF16</b>	1

## BATTERIES

### Procell Industrial Battery - D

- Pack of 10



Code

PROD10



10

### Procell Industrial Battery - AA

- Pack of 10



Code

PROAA10



10

### 9v Battery

- Pack of 10



Code

BAT9V10



10

### Procell Industrial Battery - AAA

- Pack of 10



Code

PROAAA10



10

### 6 Volt Chloride Battery

- Premium quality



ENQUIRE  
FOR  
PALLET  
RATES

Code

EB6V



12

### Procell Industrial Battery - C

- Pack of 10



Code

PROC10



10



# SITE PROTECTION

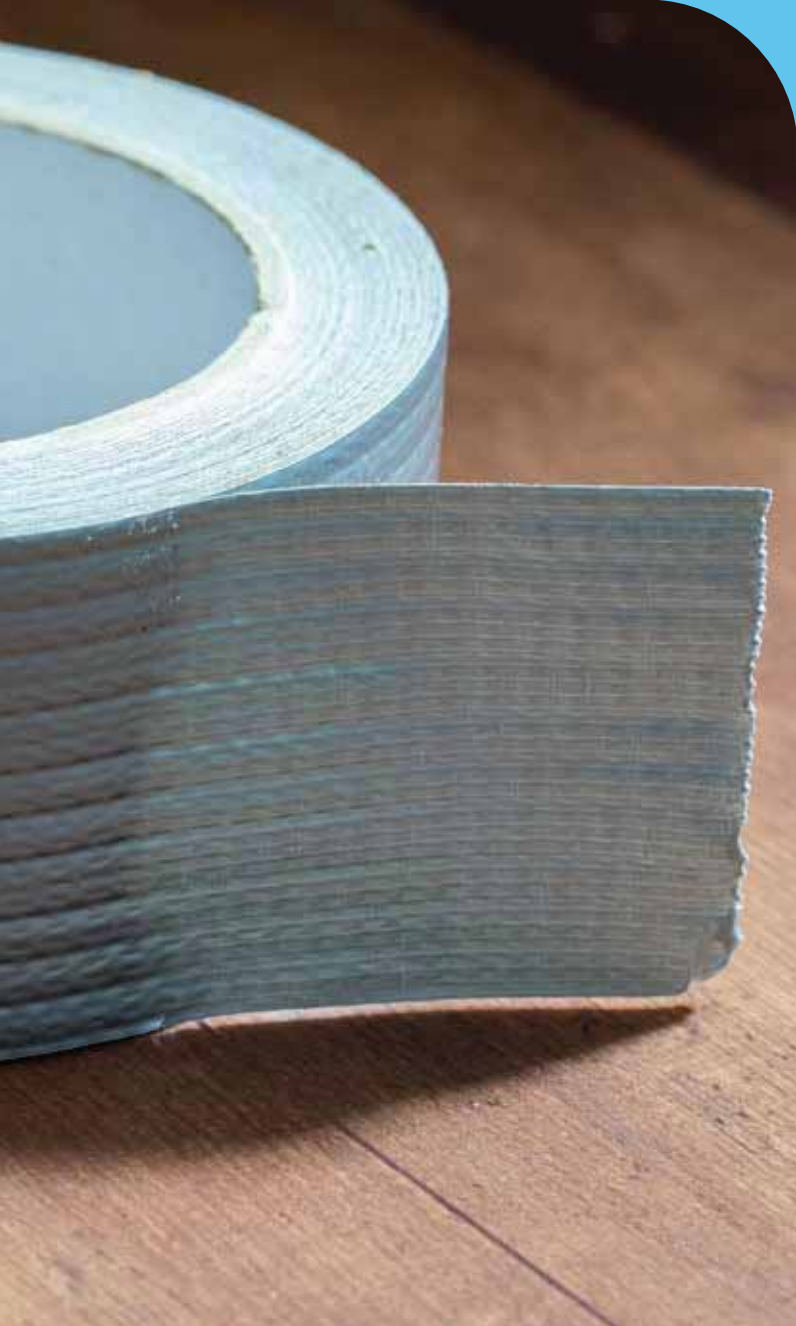

Indoor Protection	176-177
Wraps & Films	178
Ties & Tapes	179
Carpet Tiles	180

INDOOR PROTECTION

**Rigid Board  
Edge Protection**

- 50 x 50 x 4mm
- 2m length
- Protects exposed edges



Code

**EP50504**



50

**Cushion Flexible  
Foam Edge Protector**

- 75 x 75 x 2mm
- Prevents knocks and scratches to edges



Code

**FFEP75**



50

**U-Foam Handrail/  
Door Jam Protector**

- 45mm x 2m
- Protects stair handrails from damage



Code

**HRP452**



50

**Door Jam Foam Protector  
Flame Retardant**

- 2m O-profile foam tube
- Protects door frames from scrapes, chips and scuffs
- Flame retardant



Code

**DJAM2**



40

**Stair Protector  
Roll**

- 750mm x 25m
- Guards against all types of damage on stairs



Code

**SPR76025**



10

**General Purpose  
Hardboard Timber**

- 2400 x 1200mm (8' x 4')
- 3mm thick



Code

**HRDB1206**



20

### Telescopic Screen Prop

- Quick and easy to secure protective sheeting between floor and ceiling
- Extend to 3 or 4m



Code		
<b>SCR3</b>	3m	20
<b>SCR4</b>	4m	20

### Temporary Protective Sheeting

- 4 x 25m



Code		
<b>POLY260</b>	200 gauge / 50MU	1
<b>POLY480</b>	500 gauge / 125MU	1

### Temporary Downpipe

- 150mm x 165m heavy duty flexible polythene
- Simple and effective means of providing temporary downpipes on incomplete guttering systems
- Attach with cable ties or jubilee clips



Code		
<b>TDP1050</b>		1

### Dust Sheet

- 3.6 x 2.7m (12 x 9')



Code		
<b>DS129</b>		12

### Correx Sheeting - Standard

- 2.5 x 1.2m
- Branding available
- Standard correx
- Black



Code		
<b>CRXST</b>		500

### Correx Sheeting - Flame Retardant

- 2.5 x 1.2m
- Branding available
- Flame retardant
- White



Code		
<b>CRXFR</b>		500
<b>CRXFRPL</b>	Plain	500

WRAPS & FILMS

**Black Shrink Wrap Industrial**

- 500mm x 250m
- 25MU gauge



Code

**BSW10**



1

**Window Film**

- 600mm x 100m



Code

**WPFC600**



1

**Clear Shrink Wrap**

- 400mm x 250m
- 20MU gauge



Code

**CSW10**



1

**Bubble Wrap - Small Bubble**

- 1200mm x 100m



Code

**BWSB12100**



1

**Tack Mat**

- 600 x 900mm
- 36 sheets per mat
- Peel to reveal new sheet



Code

**TCKMAT**



50

**Carpet Protection Roll**

- 100m rolls



CP600

CP1200

Code

**CP600** 600mm

**CP1200** 1200mm



12

12

### Self Adhesive Barrier Tape

- 50mm x 33m

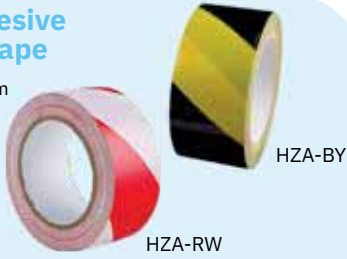

Code		
<b>HZA-BY</b>	Black & Yellow	24
<b>HZA-RW</b>	Red & White	24

### Zebra Barrier Tape

- 75mm
- Non-adhesive

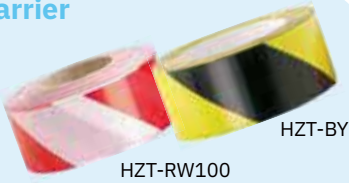

Code		
<b>HZTRW100</b>	Red & White 100m	18
<b>HZTRW500</b>	Red & White 500m	10
<b>HZTBY100</b>	Black & Yellow 100m	18
<b>HZTGW500</b>	Green & White 500m	10

### Gaffa Tape

- 50m



Code		
<b>GAFBLA</b>	Black 50mm / 2"	24
<b>GAFSIL</b>	Silver 50mm / 2"	24
<b>GAFBLA75</b>	Black 75mm / 3"	26
<b>GAFSIL75</b>	Silver 75mm / 3"	24
<b>GAFBLA100</b>	Black 100mm / 4"	12

### Double Sided Tape - Black

- 50mm x 10m



Code		
<b>DSTBLK50</b>		24

### Cable Ties

- Pack of 100
- Black, Yellow



Code		
<b>CABT200</b>	4.8 x 200mm Black	1
<b>CABT300</b>	3.6 x 300mm Black	1
<b>CABT400</b>	4.8 x 430mm Black	1
<b>CABT580</b>	12.7 x 580mm Black	1
<b>CABT710</b>	9 x 710mm Black	1
<b>CABT200/YEL</b>	4.8 x 200mm Yellow	1
<b>CABT300/YEL</b>	4.8 x 300mm Yellow	1
<b>CABT400/YEL</b>	4.8 x 400mm Yellow	1
<b>CABT430/YEL</b>	9 x 430mm Yellow	1
<b>CABT530/YEL</b>	9 x 530mm Yellow	1
<b>CABT780/YEL</b>	9 x 780mm Yellow	1

### Low Tack Protection Tape

- 50mm x 33m



Code		
<b>LTP50-BK</b>	Black	24
<b>LTP50-WHT</b>	White	24

### Masking Tape

- 25mm (1")
- 50mm (2")



Code		
<b>MT25</b>	25mm	36
<b>MT50</b>	50mm	24

## CARPET TILES

### Cityscape Tiles

- Heavy wear tile
- Pile weight: 400gr/m<sup>2</sup>
- 500 x 500mm tile size
- Polypropylene fibre
- Other colours available to order

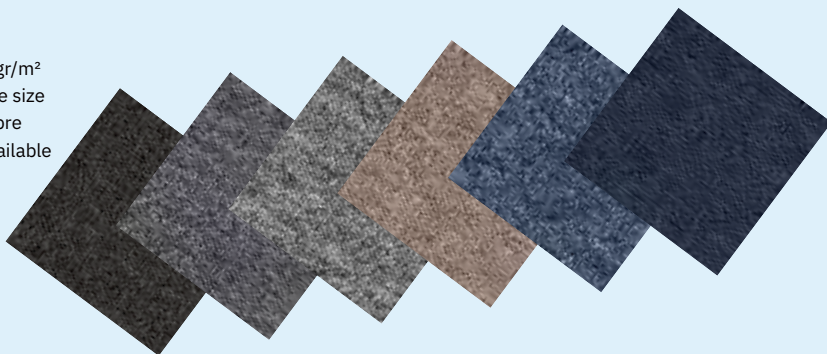

Code

**CARPTL02** Light Grey

### Urbanscene Tiles

- Heavy contract tile
- Pile weight: 550gr/m<sup>2</sup>
- 500 x 500mm tile size
- Solution dyed nylon
- Other colours available to order

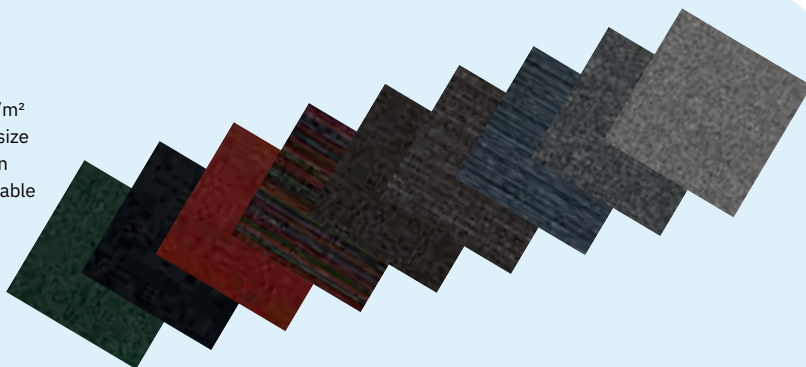

Code

**CARPTL03** Mid Grey / Anthacite

**CARPTL04** Summer Blue

### Retractable Blade Trimming Knife & Blades



Code

<b>KNF001</b>	Knife	12
<b>KNF002B</b>	Pack of 10 blades	1
<b>KNF003</b>	Pack of 100 blades	1

**CALL US NOW FOR  
PRICING & SITE  
SURVEY REQUIREMENTS**

**TECHNICAL  
SPECIFICATIONS  
& SAMPLING  
AVAILABLE**

**CALL 020 8311 1144**

# SITE FURNITURE & STATIONERY



Site Essentials  
& Stationery **182-184**

---

Canteen Tables  
& Benches **185**

---

Lockers **185**

---

Drawers & Desks **186**

---

Cabinets, Cupboards  
& Tables **187**

---

Office Chairs **188**

---

SITE ESSENTIALS & STATIONERY

Drawing Storage Trolleys

- Storage of plans, drawings, charts, maps, graphics & oversized sheets
- Trolley provides easy unobstructed access



290954

600210

Code		
<b>A290954</b>	A1 trolley	1
<b>A290946</b>	A1 plan hanger	5
<b>A600210</b>	A0 trolley	1
<b>A290938</b>	A0 plan hanger	5

Plastic Waste Paper Bin

- 15 litre
- Black



Code		
<b>OFFBIN</b>		10

Wooden Notice Board

- Cork back
- Two sizes available



Code		
<b>CTNB06</b>	900 x 600mm	1
<b>CTNB12</b>	1200 x 900mm	1

Premium Aluminium Notice Board

- Felt back
- Includes wall fixings
- 1200 x 900mm
- Other sizes & colours available to order

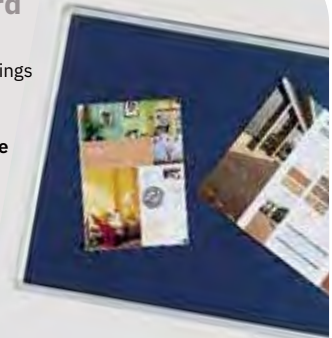

Code		
<b>NB129BL</b>	Blue	1
<b>NB129GY</b>	Grey	1

Drywipe White Board

- 1200 x 900mm
- Wooden frame
- Other sizes available to order



Code		
<b>CTWB06W</b>		1

Premium Aluminium Drywipe White Board

- 1200 x 900mm
- Aluminium frame
- Non-magnetic
- Other sizes available to order

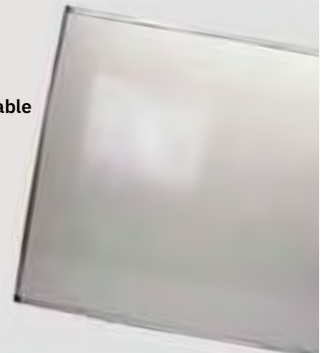

Code		
<b>CTWB06A</b>		1



Whiteboard Eraser



Code

KF01972



1

Drywipe Pens

- Pack of 4
- Black, red, green & blue



Code

CTDWP4



10

Permanent Marker  
Bullet Tip Black

- Pack of 10



Code

WX26045



10

Ball Pen Medium  
Black

- Pack of 50



Code

KF26040



10

Tipp Ex  
Pen

- Sold individually



Code

PEXL31W



1

Office  
Pencils

- Pack of 12
- HB



Code

WX01117



12

Office 2 Hole  
Punch



Code

KF01235



10

Office  
Scissors



Code

KF01228



1

SITE ESSENTIALS & STATIONERY

White Copier Paper

- Reams of 500 sheets
- Prices per ream
- 5 reams per box



Code

**PPA480** A4  
**PPA380** A3



5  
5

Hard Back A4 Lined Note Book

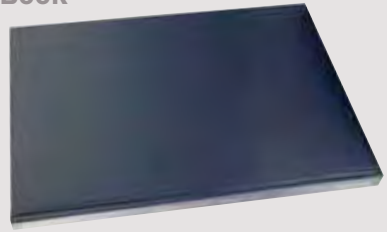

Code

**KF01060**



5

Office Stapler



KF01057

Code

**KF01057** Stapler



1

**KF27001** Staples (26/6) Box of 5000

1

Motorola TLKR 40 Two Way Radio

- Twin pack
- 8 channels
- Up to 4km range
- Requires 3 x AAA batteries per radio (not included, see page 174)



Code

**MR61583**



1

Hat & Coat Stand

- Black



Code

**HCSBLK**



1

Wall Mounted Ash Tray

- 2.7 litre
- 240 x 90 x 300mm



Code

**KF04271**



1

Wall Clock

- White wall clock with traditional design
- Face diameter: 220mm
- Requires 1 x AA battery (not included, see page 174)



Code

**WCLOCK220**



10

Fingerprint Clocking-in System

- Optical fingerprint reader
- Scratch proof
- Unbreakable and durable



Code

**A300CIM**



1

**Folding Canteen Tables**

- Plastic Top
- Easy wipe clean surface
- Durable & stable design
- Flexible legs
- 1800 x 600mm



Code



**CTTAB01** Plastic top

1

**Folding Canteen Bench**

- Extra strong reinforced seat
- Durable & stable design
- Foldable legs
- 1800 x 600mm



Code



**CTBEN01**

1

**ENQUIRE NOW FOR ALL YOUR LOCKER REQUIREMENTS CALL 020 8311 1144**

**DID YOU KNOW?**

**ENQUIRE FOR BULK RATES**



**ORDER 6AM TO 7PM FOR NEXT MORNING DELIVERY**

Set up an account for our discounted rates / prices

## DRAWERS & DESKS

### 3 Drawer Pedestals - Light Beech

- Available as desk height or mobile under desk
- Adjustable feet
- Lockable



PSR535



PSS637



Code



<b>PSS637</b>	Desk height	1
<b>PSR535</b>	Under desk	1

### Panel End Corner Crescent Desk - Light Beech

- Available in left & right hand
- 1600 wide x 600/800 deep x 720mm height



Code



<b>DDL161</b>	LH	1
<b>DDR161</b>	RH	1

### Rectangle Desks - Light Beech

- 1600 x 800 x 720
- Option of none, one or two fixed pedestals
- Pedestal options:  
3 personal drawers or 1 personal drawer and a filing drawer



Desk with built in pedestals



DDA161



Code



<b>DDA161</b>	Rectangle desk only	1
<b>DDA1621</b>	With one pedestal	1
<b>DDA1622</b>	With two pedestals	1

**Metal Filing Cabinet with 4 Drawers**

- Grey
- 4 drawers
- Other colours & sizes available to order



Code  
**SC270915**

1

**2 Door Steel Cupboard**

- Grey
- Lockable
- 914 wide x 400mm deep
- 2 heights available



Code  
**SC1000GY** 1m height, 2 shelves  
**SC1950GY** 1.95m height, 4 shelves

1  
1

**Site Tables - Light Beech**

- Beech top with sturdy metal under frame
- 50mm diameter fixed pole legs
- Available in 2 sizes



Code  
**DBA121** 1200 x 800 x 720  
**DBA161** 1600 x 800 x 720

1  
1

**Open Shelf Bookcase**

- 800 x 425 x 1954
- 4 adjustable height shelves
- Beech



Code  
**X5C081**

1

OFFICE CHAIRS

Soho Mesh Operators Chair



Code  **FNOSC01** 1

Office Swivel Chair



Code  **FNOC01** 1

Plastic Stackable Chair



Code  **CTCH01** 52

Multi Purpose Padded Stacking Chair

- Available in black or blue
- 485mm high



Code  **CTMSC-BLK** Black 25  
**CTMSC-BLU** Blue 25

CONTACT US NOW FOR DETAILS REGARDING OUR FURNITURE DESIGN INSTALLATION SERVICE



CALL 020 8311 1144



# COVID HYGIENE

Hand Sanitiser Dispensers **190-191**

Site Sanitiser Gel **191**

Site Sanitisation Station **192**

Mobile Wash Station **193**

Dispensers and Refills **194-195**

DEB Dispensers and Refills **196-197**

Alcohol Hand Sanitiser and Hand Wipes **198**

Aprons, Gowns, Disposable Gloves & Thermometers **199**

Face Masks & Visors **202**



# HAND SANITISER DISPENSERS

## Touch Free Auto Hand Sanitiser Dispenser

- PVC casing
- Anti-theft design
- Easy fill tank
- Sensor effective from 6-12cm
- Adjustable droplet amount
- Battery powered (sold separately)
- Approx. 100,000 dispensing cycles
- CE certified
- Can be supplied on a back board with custom artwork
- Actual product may vary from image



Code

**BC800PVC**



1

## Touch Free Auto Hand Sanitiser Dispenser

- Professional stainless steel casing
- Anti-theft design
- Easy fill tank
- Sensor effective from 6-12cm
- Adjustable droplet amount
- Battery powered
- Approx. 100,000 dispensing cycles
- CE certified
- Can be supplied on a back board with custom artwork
- Actual product may vary from image



Code

**BC800SS**



1

## Manual Hand Sanitiser Dispenser

- Manual hand push dispenser
- Can be mounted on a range of different surfaces
- Supplied with all the necessary wall fixings
- Easy fill tank
- Can be supplied on a back board with custom artwork
- Actual product may vary from image



Code

**BC2333**



1



## Touch Free Sanitiser Dispenser Display

- Freestanding stand for easy installation in any location
- Sturdy steel construction
- PVC dispenser
- Anti-theft design
- Easy fill tank
- Auto infrared sensor effective from 6-12cm
- Adjustable droplet amount
- Battery powered
- Approx. 100,000 dispensing cycles
- CE certified
- Can be supplied with custom artwork



Code

**HDSMBB**



1

## Hand Sanitiser Gel - 1 litre

- Easy refill for all CMT sanitiser dispensers
- 70% alcohol hand sanitiser gel
- Conforms to EN1276 and EN1500
- Quick and effective against 99.9% of germs
- Instant protection from a wide range of viral and bacterial infections
- No water or towel required
- No sticky residue
- Fast drying
- Various sizes available
- Bottle styles and designs may vary
- 1 litre

ENQUIRE FOR BULK RATES



Code

**HSG1L**

CALL FOR BULK RATES



6

## Hand Sanitiser Gel - 5 litres

- Easy refill for all CMT sanitiser dispensers
- 70% alcohol hand sanitiser gel
- Conforms to EN1276 and EN1500
- Quick and effective against 99.9% of germs
- Instant protection from a wide range of viral and bacterial infections
- No water or towel required
- No sticky residue
- Fast drying
- Various sizes available
- Bottle styles and designs may vary
- 5 litres

ENQUIRE FOR BULK RATES



Code

**JLSS05**

CALL FOR BULK RATES



4

# SITE SANITISATION STATION

## Mobile Sanitising Station

- Incorporating our 1 litre Alcohol Gel Hand Sanitiser Station
- Low level rear shelf for storage of refill cartridges and other items
- Wheeled for ease of mobility around site

Tubular steel frame that can stand up to wind and the elements

Solid industrial duty rubber tyres for mobility over uneven ground



SSTAND

Sturdy handles allow you to move the station around easily

Incorporates 1L refillable sanitiser dispenser

Safety & Information sign regarding hand care and station instructions

Low level shelf for replenishment and storage

## Walkthrough Sanitising Station

- Incorporating a walkthrough barrier and a 1 litre Alcohol Gel Hand Sanitiser Station
- Including Usage & Safety Information sign
- Right or Left hand board available
- Swivel hook and eye attachment



SANSCAFLW

Code

**SSTAND** Mobile station

**SANSCAFLW** Walkthrough station



1

1

### Heavy Duty Mobile Hand Wash Station

- No installation, plumbing or electrics required - ready to go
- Contact-free tap - foot pump ensures controlled amount of water
- Easily mobile, heavy duty steel tubular frame with all-terrain wheels
- Simple two tank supply system - 25L clean, 25L dirty - empty and refill with ease anywhere
- Provides up to 125 200ml hand washes per 25L tank fill-up
- The very robust build quality of these stations makes them ideal for site environments



Other configurations available please contact our sales team



V1



V2



V3 FRONT



V3 REAR

Code

MHWSV1	Tap, towels and cleaner	1
MHWSV2	Tap, towels, cleaner and bin	1
MHWSV3	ABC skin solutions, towels, sanitiser and bin	1

ORDER 6AM TO 7PM FOR NEXT MORNING DELIVERY

Set up an account for our discounted rates / prices

## DISPENSERS & REFILLS

### Solvent Free Hand Cleaner

- With Aloe Vera & Jojoba oil
- Solvent free
- Very powerful hand cleaner
- Cleans and moisturises
- Prevents skin irritation
- Pleasant fresh fragrance



JLDES4

JLO4



JLDES2



JLO2

Code		
<b>JLO2</b>	2 Litre Cleaner	6
<b>JLO4</b>	4 Litre Cleaner	4
<b>JLDES2</b>	2 Litre Dispenser	1
<b>JLDES4</b>	4 Litre Dispenser	1

### Orange Cleaner

- With Aloe Vera & Jojoba oil
- Solvent free
- Cleans and moisturises
- Prevents skin irritation
- Pleasant fresh fragrance



JLDES2



JLOR2

Code		
<b>JLOR2</b>	2 Litre Orange Cleaner	6
<b>JLDES2</b>	2 Litre Dispenser	1

### Universal Protect 1 Litre

- 1 litre
- Barrier to protect skin
- Silicone free



JLDES1



JLPR01

Code		
<b>JLPR01</b>	1 Litre Protect	2
<b>JLDES1</b>	1 Litre Dispenser	1

### Recondition Afterwork

- 1 litre
- Moisturises
- Stimulates natural skin recovery
- Silicone free



JLDES1



JLRES1

Code		
<b>JLRES1</b>	1 Litre Recondition	2
<b>JLDES1</b>	1 Litre Dispenser	1

## Yellow Cleaner

- Powerful citrus hand cleaner
- Cleans grease, tar, ink, adhesive & paint
- Cleans & moisturises
- Prevents skin irritation
- With Aloe Vera & Jojoba oil



JLDES2



JLYEL2



JLDES4



JLYEL4

### Code

Code	Description	Quantity
JLYEL2	2 Litre Yellow Cleaner	6
JLYEL4	4 Litre Yellow Cleaner	4
JLDES2	2 Litre Dispenser	1
JLDES4	4 Litre Dispenser	1

## Skin Care Safety Centre

- Convenient safety board encourages compliance with full skin safety
- Easy maintenance and refill
- Robust & durable for site environment
- Refills not included
- Can be supplied with custom artwork

BRAND 



### Code

Code	Description	Quantity
JLSS1	Skin Safety Centre	1

ORDER **6AM TO 7PM** FOR NEXT MORNING DELIVERY

Set up an account for our discounted rates / prices

DEB DISPENSERS & REFILLS

DEB Hand Cleaner  
Dispenser & Wash



JLHS07



JLHS03



JLHS05



JLHS12



JLDES02

Code		
JLDES02	2 litre dispenser	8
JLDES04	4 litre dispenser	10
JLHS07	2 litre pure wash	6
JLHS08	4 litre pure wash	4
JLHS03	2 litre orange	6
JLHS12	2 litre lime wash	6
JLHS13	4 litre lime wash	4
JLHS04	2 litre citrus powerwash	6
JLHS05	4 litre citrus powerwash	4

DEB Universal Protect  
Dispenser & Refill

• 1 litre



JLHS01



JLDEBPR01

Code		
JLDEBPR01		10
JLHS01		6

DEB Restore  
Dispenser & Refill

• 1 litre

FROM ONLY  
**14.39**



JLHS02



JLDEBRES1

Code		
JLDEBRES1		10
JLHS02		6

**DEB Safety Cradle**

- For 750ml & 700ml refills
- Refills not included



JLHC750



JLPC750



JLSS750



JLDEB01

Code



<b>JLDEB01</b>	Safety cradle		1
<b>JLHC750</b>	Hand Cleaner Refill	750ml	6
<b>JLPC750</b>	Protection Cream Refill	700ml	6
<b>JLSS750</b>	Sanitiser Refill	750ml	6

**DEB Sun Protect Dispenser & Refill**

- 1 litre



JLHS06



SUN1LDISP

Code



<b>SUN1LDISP</b>	Dispenser	10
<b>JLHS06</b>	Refill	6

**DEB Skin Safety Board**

- 920 x 720mm
- Board & dispensers only
- Refills not included



Code



<b>JLDEB02</b>	1
----------------	---

# ALCOHOL HAND SANITISER & HAND WIPES

## Hand Sanitiser Gel

ENQUIRE FOR BULK RATES

- 70% alcohol hand sanitiser gel
- Conforms to EN1276 and EN1500
- Quick and effective against 99.9% of germs
- Instant protection from a wide range of viral and bacterial infections
- No water or towel required
- No sticky residue
- Fast drying
- Various sizes available
- Bottle styles and designs may vary



Code



<b>HSG100</b>	100ml	CALL FOR BULK RATES	24
<b>HSG250</b>	250ml	CALL FOR BULK RATES	12
<b>HSG500</b>	500ml	CALL FOR BULK RATES	12

## Sanitiser Liquid Spray

CLEAN HANDS HEALTHY SKIN

- 65% alcohol hand sanitiser liquid spray
- Conforms to EN1276 and EN1500
- Fine liquid mist spray
- For use on hands or hard surfaces
- Quick and effective against 99.9% of germs
- Instant protection from a wide range of viral and bacterial infections
- No water or towel required
- Fast drying
- Bottle styles and designs may vary

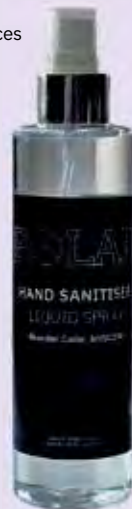

Code



<b>AHSC100</b>	100ml spray	24
<b>AHSC200</b>	200ml spray	12

## Alcohol Free Wipes

- Robust protective layer, with locking function to ensure wipes remain fresh
- Large pack size (120)
- Kind to skin - alcohol and paraben free
- Great for disinfecting areas, hands and devices
- Doesn't stain surfaces or clothing



Code



<b>JLAHW120</b>	120 wipes per pack	18
-----------------	--------------------	----

## Alcohol Wipes

- Pack of 200 wipes
- Suitable for cleaning and disinfecting a wide range of surfaces



Code



<b>JLSW200R</b>		6
-----------------	--	---



## Protective Aprons

- Clear/blue polyethylene
- Flat packed in 500 quantity
- Dimensions 1170mm x 700mm
- 16 micron thickness

ENQUIRE FOR BULK RATES

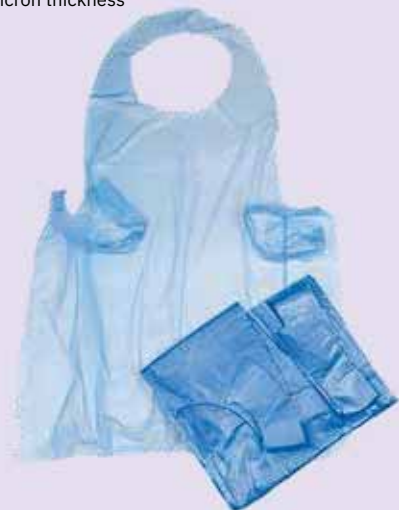

Code



**AFLAT700**

1

## CPE Fluid Repellent Surgical Gown

- Thumb loops for ease of donning gloves
- Long sleeved, open back style with waist ties
- Non-sterile, latex free
- Manufactured from CPR (polyethylene)
- Available in 1150 x 1900mm and 1200 x 1960mm
- 93/42/CE Annex VIII conformity

ENQUIRE FOR BULK RATES



Code



**IGFL**

50

## Disposable Gloves

- Nitrile or Vinyl
- Powder free
- Medical Grade AQL 1.5
- Approved for medical and industrial use
- Tested to BS EN 420:2003 + A1: 2009
- BS EN 374-1/Type C
- BS EN 455
- Latex free
- Pack of 100

ENQUIRE FOR BULK RATES



Code



**SGNDUP** Nitrile

10

**SGVDUP** Vinyl

10

## Infrared Forehead Thermometer

- Effective - Forehead temperature is an early indicator of any fluctuations
- Quick - Instantaneous result, with integrated radar technology to ensure accuracy
- Safe - Contactless and quick use ensures minimum proximity to person being checked
- Easy to use - Clearly shows red screen backlight for temperatures exceeding 37.5°C, and green if below



Code



**NCITHERM**

10

# CMT are the **first UK** manufacturer to produce certified **Type II, IIR and 3-Ply** face masks

**No.1 UK  
Manufacturer  
of Certified  
Face Masks**

Our extensive knowledge of personal protective equipment and our commitment to leading innovations in safety, led us to start manufacturing surgical and standard use masks. Producing millions of masks per week with constant expansion to accommodate demand.

Masks are fully certified to EN14638:2019, with official certification and test reports in English - making it clear and simple to process through your own compliance systems.

Production facilities are based at the same complex as our head office, with over 400,000 sq. ft. of manufacturing and warehousing. Get in touch to book a visit, and see the manufacturing process from raw material to finished masks with your own eyes.



**Type II, IIR and 3-Ply face masks are available in a range of pack sizes and packaging options, including own branding**



Our focus is on helping you in guaranteeing a consistent, secure supply of UK manufactured masks at more competitive rates than offshore-sourced products.

**Benefits of ordering through an accredited UK supplier rather than importing:**

- Removes any risk of inconsistent supply
- Save weeks of time on delivery
- Deal with a professional UK team
- Avoid overstocking with reduced MOQs
- Supports UK manufacturing
- Avoid exchange rate fluctuations
- Supports our economy

Call us: **020 8311 1144**

Email: [enquiries@cmtgroup.co.uk](mailto:enquiries@cmtgroup.co.uk)

[www.cmtgroup.co.uk](http://www.cmtgroup.co.uk)

# Specification for Type II & IIR

These high-quality products are independently tested and accredited by ISO 17025 accredited laboratories, in line with all elements of the following international standards. Test reports and other documentation are available on request.

Full product name:	Disposable Non-Sterile Medical Face Masks Type IIR 3-Ply
Product size:	180mm x 90mm (ear loops = 180mm)
Product Weight:	2 grams
Product Material:	Inner layer: White spunbonded non-woven polypropylene 25g/sqm
Outer layer:	Blue spunbonded non-woven polypropylene 25g/sqm
Filter media:	Meltblown white non-woven polypropylene 25g/sqm, 0.35mm thickness
Elastic strap:	2mm thick white elastic – latex free
Nose piece:	3mm thick metal wire encased in white plastic, 165mm length
Product Performance:	EN14683:2019 Bacterial Filtration Efficiency (BFE) $\geq$ 99% Differential Pressure $\leq$ 10.2 Pa/cm <sup>2</sup> Synthetic Blood Resistance: PASS (2R only) Microbial Contamination/Bioburden $\leq$ 23 C.F.U./g
Product Colour:	Blue / White
Packaging Size:	70mm x 200mm x 100mm
Packaging Units:	5, 10 or 50 per inner box
Manufacturer:	CMT Equipment LTD – Trident Works, Mulberry Way, Belvedere, London, DA17 6AN
Storage Conditions:	Store in a well-ventilated room where the relative humidity does not exceed 80%. Avoid high temperatures, keep away from fire and flammable materials.
Shelf Life:	5 years in original packaging
Handling:	Keep in original packaging until use – do not reuse. Replace when damp or damaged
Conformities:	EN 14683:2019: CE Marked; Registered with MHRA. Produced in accordance with MDR 2017/745. Class I medical device (non-sterile)
Dermatological Tolerance:	No known intolerance, does not contain latex
Conditions:	Non-sterile



# FACE MASKS & VISORS

## Surgical Face Masks

- 3-ply material, suitable for sensitive skin
- High elasticity ear hooks
- Comfortable fitting and easy breathing
- Latex free
- Filters dust, pollen and bacteria
- High B.F.E and P.F.E filtration
- Type IIR complies to EN 14683
- 50 masks per outer box, priced per box

ENQUIRE FOR BULK RATES



Code



<b>SFM3L</b>	Standard 3-Ply	CALL FOR BULK RATES	50
<b>SM100</b>	Type II	CALL FOR BULK RATES	50
<b>SM120</b>	Type IIR - Fluid Resistant Layer	CALL FOR BULK RATES	50

## Reusable Cloth Face Masks

- 100% cotton
- Washable at 60 degrees
- Double cotton layer for extra protection
- Can be used for extended periods
- Elasticated straps for good fit
- Masks available in black or white



Code



<b>CFM2L-W</b>	White	CALL FOR BULK RATES	20
<b>CFM2L-B</b>	Black	CALL FOR BULK RATES	20

## Full Face Protective Visor

- Conforms to EN166
- Elastic headband
- Foam forehead band for extra comfort
- Visor suitable for use with face masks
- Can be used for prolonged periods



Code



<b>SFSVISOR</b>			5
-----------------	--	--	---

# JANITORIAL & CATERING



Eco Cleaning Products	204-205
Cleaning Products	206-208
Hand Cleaning	209
Hand & Surface Wipes	210
Rags, Cloths & Sponges	211
Toilet Rolls, Paper Towels & Dispensers	212-213
Bins	214
Bin Liners & Sacks	215
Vacuum Cleaners	216
Dustpans, Brushes & Doormats	217
Brushes, Litter Pickers & Wet Floor Sign	218
Mops & Buckets	219
Canteen Supplies	220-223
Canteen & Welfare Equipment	224-225
Personal Care & Boot Cleaners	226

ECO CLEANING PRODUCTS



VEGAN FRIENDLY PRODUCTS



CRUELTY FREE PRODUCTS



ECO FRIENDLY PRODUCTS



PLANT BASED INGREDIENTS



SEPTIC TANK SAFE



AQUATIC LIFE SAFE



Naturewatch Foundation

For the advancement of animal welfare



PET FRIENDLY PRODUCTS

Eco Friendly Multi Surface Cleaner

- Powerful solution using natural plant extracts to lift away dirt and grime
- Formulated for a quick and easy clean
- Kills 99.9% bacteria
- Suitable to use on most hard surfaces
- 750ml



Code

ECOMSC750



12

Eco Friendly Window & Glass Cleaner

- Removes stubborn dirt & marks from windows, glass & mirrored surfaces
- Fast dry action formula
- Smear & streak free clean
- 750ml



Code

ECOWGC750



12

### Eco Friendly Toilet Cleaner

- Removes limescale & water mark staining
- Deep cleans, freshens & sanitises
- Kills germs & bacteria
- 750ml



Code

ECOTC750



12

### Eco Friendly Washing Up Liquid

- Powerful foaming action that cuts through grease
- Long lasting concentrated formula
- Leaves dishes sparkling
- 500ml



Code

ECOWU500



12

### Eco Friendly Natural Hand Soap

- Neutralises 99.9% harmful bacteria
- Gentle on skin
- Food safe
- Suitable for domestic office and catering uses
- Sustainable naturally derived raw materials
- Hypoallergenic suitable for sensitive skin
- Readily biodegradable
- Exact packaging may vary
- 500ml



Code

ECOHS500



12

**CLEANING PRODUCTS**

**Washing Up Liquid**



JLWUL01



JLWUL02



JLWUL05

**BEST  
SELLER**

Code

JLWUL01	500ml
JLWUL02	1 litre
JLWUL05	5 litre

12
12
4

**Multi Surface Cleaner**



JLBS500



JLHSC05

**BEST  
SELLER**

Code

JLBS500	500ml
JLHSC05	5 litre

12
4

**Fairy Washing Up Liquid**

• 900ml



Code

FL750

12
----

**Pine Disinfectant**

• 5 litre



Code

JLDI05

4
---

**Standard or Thick Bleach**



Code

JLBL05	5 Litre Standard
JLTBL05	5 Litre Thick
JLTBL01	1 Litre Thick

4
4
4



**Liquid Descaler**

- 5 litre



Code

JLDS05



4

**P-Wave Urinal Screen**

- Stay fresh for 30 days
- Pack of 10
- Mango

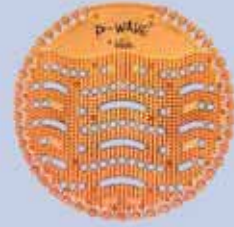

Code

URSC-MA



6

**Urinal Blocks**

- 3kg bucket



Code

JLUB03



4

**Toilet Cleaner**

- 750ml

**BEST  
SELLER**



Code

JLTC750



12

**Glass, Window & Stainless Steel Cleaner**

- 750ml
- Trigger spray



Code

JLGC750



12

**Duck Toilet Cleaner**

- 750ml



Code

JLTD750



12

**Original Cream Cleaner**

- 500ml



Code

JLCC500



12

**Furniture Polish**

- Aerosol - fragrance may vary



Code

JLFP480



12

**CLEANING PRODUCTS**

**Air Freshener Spray**

- Aerosol - fragrance may vary



Code  **JLAF400** 12

**Air Freshener Gel**

- Solid gel
- 150ml



Code  **AFSOL** 12

**Fly & Wasp Spray**

- 300ml



Code  **FLYS300** 12

**Ink & Gum Remover**

- 400ml



Code  **R255400** 1

**Brick & Patio Cleaning Acid**

- 5 litre



Code  **BCA5L** 4

**Jizer Bio**

- Biodegradable
- Multi-surface
- Concentrated
- Low odour
- 2 litre



Code  **JLJB05** 4

**Floor Cleaner**

- 5 litre



Code  **FC5L** 4

**Dusmo Red Label Sweeping Compound**

- An abrasive sweeping compound suitable for many floor types



Code  **DUSRED6** 1

**Spring Cleaning Kit**

- Everything you need to clean in one handy plastic box with lid



Code  **S43901** 1

HAND CLEANING

**Buttermilk Soap Bar**

- 72 per box

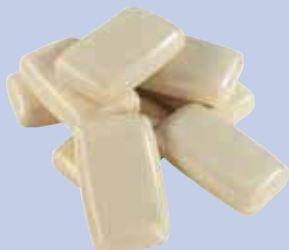

Code



JLHS09

1

**Liquid Hand Soap**

- 300ml & 5 litre
- Anti-bacterial



Code



JLAHS10 300ml

12

JLHS11 5 litre

4

**Carex Anti-Bacterial Soap**

- 250ml
- With hand pump



Code



CHS500

6

**Nail Brush**



Code



MNB4PL

10

**Swarfega Original**

- 4.5 litre



Code



JLSWAORI

4

**Swarfega Orange**

- 4.5 litre



Code



JLSWAORG

12

**MAX Industrial Hand Cleaner**

- 5 litre tub
- Grease dissolving
- Beaded hand gel
- Pump also available



Code



MAXGEL5

1

**MAX Hand Barrier Cream**

**BEST SELLER**

- 500ml
- Pre work hand cream for protection in wet & dry environments



Code



MAXBAR500

12

# HAND & SURFACE WIPES

## Alcohol Free Wipes

- Large pack (120)
- Alcohol and paraben free
- Locking function ensures wipes remain fresh
- Disinfects



Code  **JLAHW120** 120 wipes per pack **18**

## Alcohol Wipes

- Pack of 200 wipes
- Suitable for cleaning and disinfecting a wide range of surfaces



Code  **JLSW200R** **6**

## Paintbuster Wipes

- Tub of 50
- Suitable for hands & hard surfaces



Code  **JLPBUSTER** **6**

## 4 in 1 Household Anti-Bacterial Wipes

- 40 large wipes per pack
- Cuts through kitchen grease
- Removes bathroom grime
- Kills 99.99% of bacteria
- Resealable tab



Code  **WIPE002** **24**

## MAX Workshop Wipes

- Industrial multi-purpose wipes
- Clean hands, tools & surfaces
- 150 or 200 wipes in easy dispense tubs



JLWW150



JLWW200

**BEST SELLER**

Code  **JLWW150** 150 wipes **8**  
**JLWW200** 200 wipes **4**

**Assorted Rags**



Code		
<b>JLRAGS</b>	Assorted cotton	1
<b>JLRAGSWHT</b>	White silk-free	1

**J Type Cloths**

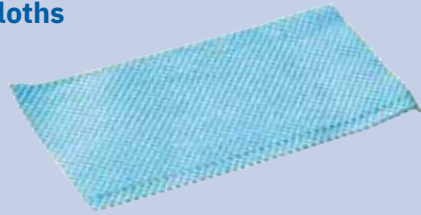

Code		
<b>JLCL02A</b>	Pack of 10	1
<b>JLCL02B</b>	Pack of 50	1

**Microfibre Cloths**

- Pack of 10
- 230gsm
- Excellent fibre split for effective microfibre cleaning
- Can be washed repeatedly



Code		
<b>MICROCF</b>		1

**Large Sponges**

- Pack of 10



Code		
<b>JLSP10PK</b>		1

**Scouring Pads**

- Pack of 10



Code		
<b>JLSC10</b>		1

**Yellow Dusters**

- Pack of 10

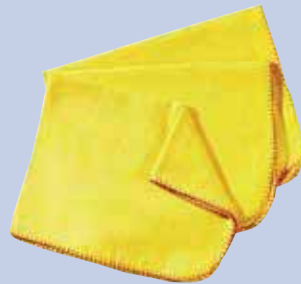

Code		
<b>YD001</b>		1

**Tea Towels**

- Pack of 10

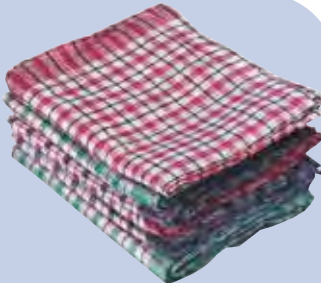

Code		
<b>JLTT10</b>		1

**Dish Cloths**

- Pack of 10



Code		
<b>JLCL01</b>		1

**TOILET ROLLS, PAPER TOWELS & DISPENSERS**

**Toilet Tissue**

- 200 sheet
- 2 ply
- 36 pack



Code

**JLTR0036**



1

**Premium Toilet Tissue**

- 320 sheet
- 2 ply
- 36 pack



Code

**TR320**



1

**Toilet Roll Dispenser**

- Strong & durable ABS plastic
- Lockable
- Takes 2 rolls



Code

**A107471**



1

**10" Hygiene Roll**

- 250mm (10") x 40m
- 2 ply
- Pack of 18 rolls



Code

**HR10**



1

**Katrin White Paper Z-fold Hand Towel**

- 3000 towels per pack



Code

**JLWPHT-Z**



1

**Forecourt Auto Wipe**

- Blue & white
- 28cm x 400m
- 2 ply / 1000 sheets
- Pack of 2 rolls

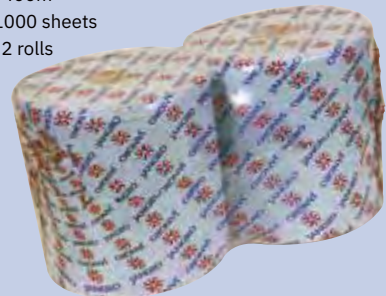

Code

**MRAW**



1

**Jumbo Roll**

- 3" core x 300m
- 2 ply
- 6 rolls per pack



Code



JTR

1

**Dispenser for Jumbo Rolls**



Code



A107470

1

**Centre-Feed Roll**

- 50m
- 2 ply & 3 ply
- Blue or white
- Pack of 6



Code



JLJR150/6 Blue / 2 ply

1

JLWJR6 White / 2 ply

1

JLJR150/6P Premium / 3 ply Blue

1

**Dispenser for Centre-Feed Roll**



Code



JLCFRDIS

1

**Paper Hand Towels**

- Available in C-fold or Z-fold
- C-fold, green, box of 2640
- Z-fold, white, box of 2400

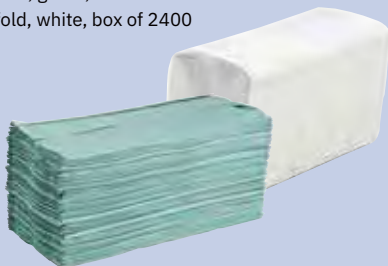

Code



JLGPHT C-fold, green

1

JLGPHTZ Z-fold, white

1

**Dispenser for Paper Hand Towels**

- Strong & durable ABS plastic
- Suitable for C-fold or Z-fold



Code



JLGPHTDIS

1

**BINS**

**Wheelie Bin 240L**

- 240 litre
- Other colours available on enquiry



Code		
<b>WB240LGN</b>	Green	1
<b>WB240BLK</b>	Black	1
<b>WB240LGRY</b>	Grey	1
<b>WB240LYEL</b>	Yellow	1
<b>WB240LBLU</b>	Blue	1
<b>WB240LRED</b>	Red	1

**Wheelie Bin**

- Green
- 1100 & 660 litre



Code		
<b>WB1100LGN</b>	1100 litre	1
<b>WB660LG</b>	660 litre	1

**Swing Bin**

- 50 litre
- Approx: W 420 x D 335 x H 665mm



Code		
<b>SWPB50</b>		1

**Black Dustbin**

- 80 litre
- Complete with lid



Code		
<b>JLDB800</b>		1

**Galvanised Dustbin**

- 600 x 450mm (24 x 18")
- 80 litre
- Complete with lid



Code		
<b>DBG15</b>		1

**Grit Bin**

- Yellow
- Choice of 2 sizes
- 250kg or 450kg capacity



Code		
<b>JLGRIT250Y</b>	250 litre	1
<b>JLGRIT450Y</b>	450 litre	1



**BIN LINERS & SACKS**

**Plastic Waste Paper Bin**

- 15 litre
- Black



Code

**OFFBIN**



10

**Asbestos Sacks**

- Clear or red
- 600 x 900mm



Code

**ADSCC** Clear

**ADSCR** Red



50

50

**Swing Bin Liners**

- 13 x 23 x 30"
- White
- 100g
- Pack of 500



Code

**JLBLW500**



1

**Black Bin Liners - Light Duty**

- 18 x 29 x 34" approx
- 12kg
- 100g
- Box of 200



Code

**JLBL200L**



1

**Black Bin Liners - Medium Duty**

- 18 x 32 x 39" approx
- 15kg
- 150g
- Box of 200



Code

**JLBL200M**



1

**Black Bin Liners - Heavy Duty**

- 18 x 29 x 39" approx
- 20kg
- 200g
- Box of 200

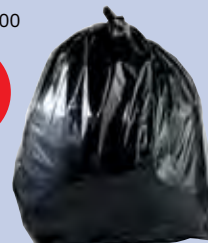

Code

**JLBL200HD**



1

**Plastic Rubble Sacks**

- Blue
- 76 x 50cm
- Pack of 100

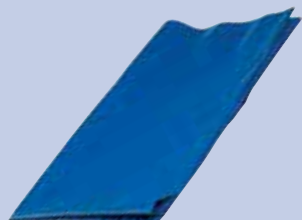

Code

**JLRUB100**



1

**Woven Rubble Sacks**

- Tough 70gsm woven reusable rubble sacks
- Puncture resistant
- Pack of 10



Code

**JLRUB10**



1

**Wheelie Bin Bags**

- Black
- 30 x 46 x 54"
- 100g
- Pack of 100



Code

**JLWBS1**



1

## VACUUM CLEANERS

### Numatic Vacuum Cleaner & Bags

- 110v or 240v



HHB10



Code



**NRV200-110** 110v Numatic vacuum 1

**NRV200-240** 240v Numatic vacuum 1

**HHB10** Numatic cleaner bags - pack of 10 1

### MAX Wet & Dry Vacuum Cleaner - 15 Litre

- 1200W
- 220-240V
- 4 metre power cord
- Weight 4kg
- Wet & dry filters



Code



MAXVAC15

1

### MAX Wet & Dry Vacuum Cleaner - 30 Litre

- 1400W
- 220-240V
- 4 metre power cord
- Weight 6kg
- Wet & dry filters



Code



MAXVAC30

1

Plastic Dustpan & Brush



Code

JLDB01



1

Metal Dustpan



Code

JLDB02



15

Bassine Fill Churn Hand Brush



Code

BCHB



10

PVC Fill Churn Hand Brush



Code

PVCCHB



10

Bassine Hand Brush



Code

JLBR02



50

Coco Hand Brush



Code

JLBR03



50

Coco Door Mat

- 685 x 400mm



Code

CDM64



1

Boot Cleaner



Code

BRBC



1

**BRUSHES, LITTER PICKERS & WET FLOOR SIGN**

**Toilet Brush & Holder**



Code

JLBR05



24

**Caution Wet Floor Sign**

- Sign reads "Caution Wet Floor" & "Cleaning in Progress"
- Folds flat to store away
- Carry handle



Code

DS55N



1

**Litter Picker**



JLLIT

STV333

Code

JLLIT Plastic

STV333 Professional



12

12

**Deck Scrub**



Code

JLBR01



1

**FOR OUR RANGE OF BROOMS & BRUSHES SEE PAGES 74 - 75**

**HAVE YOU SEEN?**



### Professional Mop Head & Mop Handle

- Head & handle supplied separately
- Push on to the handle
- PY12 head



Code		
<b>JLPMHEAD</b>	Mop head	12
<b>JLPMHANDL</b>	Handle	12

### Kentucky Mop with Multi fold Head

- Head & handle supplied separately



Code		
<b>KENTKMOP</b>	Mop head	10
<b>KENTMH</b>	Handle	10

### String Mop Head & Mop Handle

- Head & handle supplied separately



Code		
<b>JLMOPO2</b>	Mop head	10
<b>JLMOPO3</b>	Handle	10

### Plastic Mop Bucket

- Heavy duty
- Wringer cone



Code		
<b>BPM15</b>		1

### Metal Mop Bucket

- Galvanised
- With wringer cone
- 7 litre (1.5 gallon)



Code		
<b>BM20</b>		1

### Kentucky Wringer Bucket

- 24 Litre
- Available in Blue, Green, Red & Yellow



Code		
<b>BBM03</b>		1

**CANTEEN SUPPLIES**

**Nescafé Original Coffee**

- 500g or 750g



Code		
<b>CTCG500</b>	500g	6
<b>CTCG750</b>	750g	6

**Nescafé Gold Blend Coffee**

- 750g



Code		
<b>CTCGB750</b>		6

**Tetley Tea Bags**

- Choice of quantities



Code		
<b>TB240TET</b>	240 bags	1
<b>TB440TET</b>	440 bags	6
<b>TB1100TET</b>	1100 bags	2

**PG Tips Tea Bags**

- 1150 bags



Code		
<b>TB1100PGT</b>		1

**Yorkshire Tea Bags**

- 3kg
- 1200 bags



Code		
<b>TB1200YT</b>		2

**Granulated Sugar**

- 1kg granulated pack
- 2kg vending pack



Code		
<b>CTSG01</b>	1kg	16
<b>CTSG02</b>	2kg	16

**Sugar Sachets**

- Pack of 1000 sachets
- White



Code		
<b>CTSGS1K</b>		1

**Canteen Cannister Set**



- Tea, coffee & sugar
- Product style may vary



Code		
<b>TCSSET</b>		1

### Semi Skimmed Milk

- UHT longlife milk
- 1 litre carton or box of 120 portions



Code		
<b>MILK01</b>	1 litre	6
<b>MILK02</b>	120 portions	12

### Aquapax Spring Water Cartons

- The recyclable alternative to plastic bottles
- Packs of 12
- 500ml



Code		
<b>AQUA50012</b>		105

### Bottled Spring Water

- 500ml
- Packs of 24



Code		
<b>CTSW24L</b>		84

### Water Dispenser

- Suitable for **CTWATD020** 15 litre bottles (not included)
- 240v



Code		
<b>CTWATD020</b>	240V	1
<b>CTWATD020-110</b>	110V	1

### Water Bottle - 15 litre

- 15 litre recyclable
- English mineral water
- To suit **CTWATD020** dispenser (opposite)



Code		
<b>CTWATB015</b>		46

**CANTEEN SUPPLIES**

**Stainless Steel Cutlery**

- Packs of 12



Code		
<b>CTKNIF12</b>	Knives	10
<b>CTSPN12</b>	Dessert spoons	10
<b>CTFORK12</b>	Forks	10
<b>CTTSPN12</b>	Teaspoons	10

**Plastic Cutlery**

- Packs of 12



Code		
<b>CTKNIFPL</b>	Knives	10
<b>CTSPNPL</b>	Dessert spoons	10
<b>CTFORKPL</b>	Forks	10
<b>CTTSPNPL</b>	Teaspoons	10

**Plastic Cups**

- Clear plastic drinking cups
- 7oz
- Box of 3000



Code		
<b>CTDC72000</b>		1

**Polystyrene Cups**

- Brilliant for hot drinks
- 10oz
- Box of 1000



Code		
<b>CTPC1000</b>		1

**Cup Sleeves**

- Compostable, biodegradable recycled cardboard
- To suit 8oz - 12oz cups
- Pack of 2000



Code		
<b>COMCS2000</b>		6

**Paper Plates**

- 9"
- Packs of 100



Code		
<b>PP9100</b>		12



### Wooden Cutlery

- Eco friendly alternative to plastic
- Packs of 100



NEW

Code		
<b>WDNKNIF</b>	Knives	10
<b>WDNDESP</b>	Dessert spoons	10
<b>WDNFORK</b>	Forks	10
<b>WDNTASP</b>	Teaspoons	10
<b>WDNS1000</b>	Stirrer	10

### Paper Drinking Cups

- Compostable & biodegradable
- 8oz single wall
- Box of 1000



NEW

Code		
<b>COMCUP8</b>		1

### Ceramic Bowls

- Packs of 6



Code		
<b>CTBOWL6</b>		36

### Ceramic Plates

- Packs of 6
- 17 or 25cm



Code		
<b>CTPLATE17</b>	17cm	36
<b>CTPLATE25</b>	25cm	12

### Ceramic Mug

- Each



Code		
<b>CTMUG</b>		36

### Washing Up Bowl & Brush

- Plastic
- Colours may vary



CTWUPB



CTWWUB

Code		
<b>CTWUPB</b>	Washing up bowl	1
<b>CTWWUB</b>	Washing up brush	24

**CANTEEN & WELFARE EQUIPMENT**

**Hot Water Urn**

- 20 litre capacity
- 240v
- Other sizes available



Code  **CTURN20** 1

**Microwave Oven**

- 6 power settings including defrost
- W 452 x D 330 x H 262mm
- 240v
- 800w



Code  **MICROWAVE** 1

**Premium Cordless Kettle**

- 1 litre
- 240v
- Stainless steel
- Removable, washable filter

**NEW**



Code  **KET02** 1

**Premium Toaster**

- 240v
- Stainless steel
- 4 slice



Code  **TOAST02** 1

**Cordless Kettle**

- 1.7 litre
- 240v



Code  **KET01** 1

**Site Toaster**

- 240v
- 800w



Code  **TOAST01** 2 Slice 1  
**ECTOAST04** 4 Slice 1

### Site Fridge - Under Counter

- A+ energy efficiency
- Reversible door
- W 470 x D 440 x H 820mm
- 240v
- Now available with freezer unit **FRIDGE-SE**



Code



<b>FRIDGE</b>	Fridge	1
<b>FRIDGE-SE</b>	Fridge & Freezer	1

### Site Dishwasher

- Free-standing dishwasher
- Able to accommodate 12 place settings
- 3 temperature settings
- Cutlery basket
- Easy clean filter
- Low salt and rinse aid indicators
- Energy rating: A/AA



Code



<b>CTDW01</b>		1
---------------	--	---

### Dishwasher Tablets

- Pack of 30
- Contains detergent, disinfectant & rinse aid



Code



<b>JJLDWT</b>		10
---------------	--	----

### Dishwasher Salt

- 2kg
- Crystal dishwasher salt is designed for use with dishwashers & softeners



Code



<b>DWSALT</b>		10
---------------	--	----

### Rinse Aid

- 500ml
- Prevents soap residue
- Suitable for use with all dishwashers



Code



<b>DWRA</b>		12
-------------	--	----

### Chlorine Tablets

- Each tablet provides 2% chlorine solution in 5 litres of water
- Tub of 200



Code



<b>CHLORTAB200</b>		4
--------------------	--	---

**PERSONAL CARE & BOOT CLEANERS**

**Hand Sanitiser Gel - Anti-Bacterial**

- 70% alcohol hand sanitiser gel
- Bottle styles and designs may vary



ENQUIRE FOR BULK RATES

Code			
<b>HSG100</b>	100ml	CALL FOR BULK RATES	24
<b>HSG250</b>	250ml	CALL FOR BULK RATES	12
<b>HSG500</b>	500ml	CALL FOR BULK RATES	12

**DEB Sun Protect Tube**

- 100ml
- 30 SPF



Code	
<b>JLHBC150</b>	12

**Suncream EAD SPF30**

- 30 & 50 SPF
- 100ml
- Water resistant



Code		
<b>JLSUN01</b>	Factor 50	24
<b>JLSUN02</b>	Factor 30	24

**Coco Coir Door Mat**

- 685 x 400mm



Code	
<b>CDM64</b>	1

**Boot Cleaner**



Code	
<b>BRBC</b>	1

**Bootwash Portable Water Filled Boot Cleaner**

- Simply fill with water
- 3 tough bristle brushes combine to remove mud & debris from sole and sides in one movement
- Made from heavy gauge steel with powder coated finish



Code	
<b>BOOTWASH</b>	1

**FOR CMT & DEB DISPENSERS & REFILLS SEE PAGES 194 - 197**

**HAVE YOU SEEN?**



# ENVIRONMENTAL



Spill Kits & Granules	228-229
Plant Nappies & Pallet Sumps	230
Drip Trays	231
Oil Retention Mats & Drain Filters	233
Oil & Sediment Dewatering Filters	234
Hushtec - Sound Control Solutions	235-239
Eco Cleaning Products	240-241
Aquapax Spring Water	242-243
Eco Cutlery & Cups	244

SPILL KITS

Oil Spill kit

- Oil only
- Contains absorbent pads, socks and hazardous waste bags
- Clip close carry bag with handle
- 15L: 10 pads, 1 sock, 1 bag (and cable tie)
- 30L: 15 pads, 3 socks, 1 bag (and cable tie)



Code



SK15L 15 Litre

1

SK30L 30 Litre

1

50 Litre Oil & Fuel Spill Kit With Shoulder Bag

- Vinyl holdall
- Water resistant
- Contains absorbent pads, socks and hazardous waste bags



Code



SK50LOF

1

Oil Spillage Absorbent Sock

- 8cm x 1m
- Absorbs 3 litres per sock
- Price per sock



Code



SKSOCK

20

**90 Litre Spill Kit**

- Oil only
- 1 plastic drum & lid,
- 4 x 3m absorbent socks,
- 40 absorbent pads,
- 3 waste bags



Code		
SK90L		1

**Spill Kit c/w Portable Bin**

- Oil only
- 120L or 240L
- Pads, socks & bags



Code		
SK120L	120 Litre	1
SK240L	240 Litre	1

**Spillage Granules**

- 20 Litres
- 15.5 kg
- Oil only



Code		
SPG25		70

**Oil Spillage Absorbent Pad**

- Pack of 100
- 39 x 48cm
- Absorbs up to 85 litres



Code		
SK100PAD		1

## PLANT NAPPIES & PALLET SUMPS

### Plant Nappy Base Yellow & Blue

- 3 sizes available
- To suit Plant Nappy liners



Code	Dimensions	Liner	Absorbency	
<b>DRIP12</b>	685 x 500mm	DRIP13	2L	10
<b>DRIP04</b>	1000 x 685mm	DRIP05	4.5L	10
<b>DRIP07</b>	2000 x 1370mm	DRIP08	16L	2

### Plant Nappy Liner Yellow & Blue

- 3 sizes available
- To suit Plant Nappy bases



Code	Dimensions	Base	
<b>DRIP13</b>	685mm x 500mm	DRIP12	20
<b>DRIP05</b>	1000mm x 685mm	DRIP04	20
<b>DRIP08</b>	2000mm x 1370mm	DRIP07	5

### 2 or 4 Drum Pallet Sump

- 1300 x 750mm  
2 drum
- 1260 x 1280mm  
4 drum
- Includes grating



Code		
<b>DRIP02</b>	2 drum	1
<b>DRIP04</b>	4 drum	1



### Value Drip Tray

- 790 x 400 x 40mm
- Plastic
- 11 Litres



Code  **DRIP01S** 1

### Premium Drip Tray

- 765 x 465 x 80mm
- Premium quality plastic
- 23.5 litres



Code  **DRIP01P** 5

### Square Deep Drip Tray

- 1000mm or 1200mm square
- 120mm deep
- Heavy duty plastic

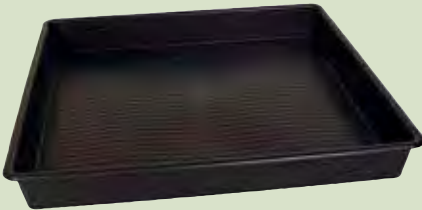

Code  **DRIP1012** 1000mm 1  
**DRIP1212** 1200mm 1

### Extra Deep Drip Tray

- 1000 x 550 x 150mm
- Heavy duty plastic
- 40 litres

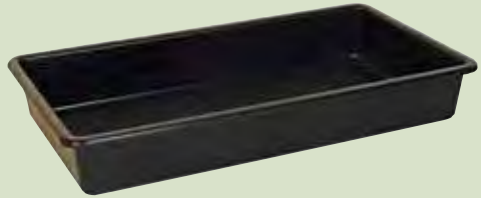

Code  **DRIP10** 1

### Steel Drip Tray

- Steel
- 900 x 600 x 50mm
- 25 litres
- Deep storage lip for anti-spill

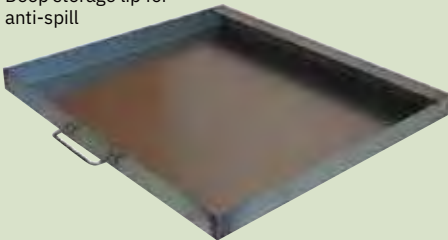

Code  **DRIPM23** 1

### Lipped Spill Containment Tray

- 1000 x 1000mm



Code  **MMT1000** 1



# green rhino®

Smart Pollution Prevention Products



## EnviroPad®

### The ultimate product for drips and spills

The EnviroPad® captures and solidifies oil, diesel and other hydrocarbons. Unlike typical products which work like a sponge and are prone to leak, EnviroPad® uses a proprietary blend of polymers which immediately starts to turn the spill solid, permanently capturing it within the filtration membrane. This eliminates unwanted leaks, reduces waste and importantly saves times and money.



- Best oil retention rates on the market, up to 44 litres
- Unrivalled cost per litre compared to the marketplace
- Usage instructions printed on the EnviroPad®
- Clean, safe, reliable pollution prevention
- 5 different sizes available



S4



M10



L20



L30



L40

**EnviroPad®**  
**S4 Small**  
 Up to 4.5L

**EnviroPad®**  
**M10 Medium**  
 Up to 10.5L

**EnviroPad®**  
**L20 Large**  
 Up to 20.2L

**EnviroPad®**  
**L30 Large**  
 Up to 30.4L

**EnviroPad®**  
**L40 Large**  
 Up to 44.3L

## EnviroPad Oil Retention Mat

- Turns oil into rubber for highly efficient spill containment
- Solidifies the spill so contaminants cannot leak out
- Clean, safe, reliable pollution prevention
- Avoid fines and prosecution from environmental regulators



Code

<b>GRR520201EPAD</b>	Small - S4 / 610mm x 460mm / up to 4.5L oil
<b>GRR520210EPAD</b>	Medium - M10 - 900mm x 690mm / up to 10.5L oil
<b>GRR520105EPAD</b>	Large - L40 - 2180mm x 1370mm / up to 44.3L oil



15

15

4

## EnviroHorn Drain Filter

- Eliminate cost & time consuming process of regular drain unblocking
- Quick & effective pollution solution
- Reduces site down time



Code

<b>GRR100001EHRN</b>	250mm dia. x 400mm deep / capacity - 1L oil, 19kg sediment
<b>GRR100101EHRN</b>	250mm dia. x 400mm deep / capacity - 21kg sediment



10

10

ORDER **6AM TO 7PM** FOR NEXT MORNING DELIVERY

Set up an account for our discounted rates / prices

# OIL & SEDIMENT DEWATERING FILTERS

## Sediment Dewatering Filter

- Wash to re-use
- Hi-Vis yellow casting
- Retains 20kg of sediment minimum
- Mitigates vacuum tankering fees & reduces site downtime
- Easy to use & quick to attach
- Water discharges to environment regulators accepted levels



Code		
<b>GRR010601BFIL</b>	Budget Sediment Filler - 100 micron - 1500mm x 350mm x 350mm / 20kg sediment	12
<b>GRR010502SEDO</b>	Sediment Dewatering Filter - 150 micron - 1500mm x 350mm / 20kg sediment	25
<b>GRR010510SEDO</b>	Sediment Dewatering Filter XL - 150 micron - 1500mm x 800mm / 40kg sediment	20

## Oil & Sediment Filter

- Can be emptied and washed for repeated use
- Removes oil sheen from water
- Mitigates vacuum tankering fees & reduces site downtime
- Easy to use & quick to attach
- Water discharge to environment regulators accepted levels
- 1.5m x 350mm
- 150 micron
- 2.5L oil, 20kg sediment



Code		
<b>GRR010001OILS</b>	1.5m x 350mm	6



SAFESMART  
ACCESS  
Reaching new heights

SOUND CONTROL SOLUTIONS  
AVAILABLE FOR HIRE OR SALE

0845 382 1000  
www.safesmartaccess.co.uk

SAFESMART  
ACCESS  
Reaching new heights

SOUND CONTROL SOLUTIONS  
AVAILABLE FOR HIRE OR SALE

0845 382 1000  
www.safesmartaccess.co.uk

SAFESMART  
ACCESS  
Reaching new heights

SOUND CONTROL SOLUTIONS  
AVAILABLE FOR HIRE OR SALE

0845 382 1000  
www.safesmartaccess.co.uk

## SOUND CONTROL SOLUTIONS

Hushtec Global was born with a passion of bringing to market innovative solutions that protect people, the environment and increase health and safety measures across a wide range of industries.

Hushtec are a worldwide practical safety solutions provider that were formed as a result of a driven family business committed to continuous development and improvement.

## HUSHTEC BARRIERS

Performance Series  
Barrier

NEW

We have proven through extensive trials, tests & re-designs that our panels are incredibly durable. We have combined the most enduring material properties to provide a weatherproof and UV-resistant acoustic panel that will withstand the toughest conditions with minimal deteriorations.

- Noise absorption of up to 75%
- Custom size panels available
- Full printed personalisation available to enhance your company brand and environmental image
- Quick and easy to erect
- Can also control the spread of dust and fumes
- Weather and UV Resistant



Code

HUSHP13

## Phone Box

NEW

The new Hushbox phone station provides a quiet environment for site personnel to make phone calls. In the event of an emergency, conversations can be heard clearly with no background noise interference, making response times quicker and potentially saving lives.

- Quick and easy to install - recommended positioning is every 30 - 40m apart
- Lightweight and relocatable
- Ideal document station
- Reflective strip and fluoro colours available for increased site awareness
- Width: 750mm  
Height: 750mm  
Depth: 750mm
- Custom branding and sizing available



Code

HUSHPB

ORDER 6AM TO 7PM FOR NEXT MORNING DELIVERY

Set up an account for our discounted rates / prices

237

## HUSHTEC ROCK BREAKER ATTACHMENT

### Rock Breaker Attachment

The all new Hushtec Rock Breaker noise control attachment was developed to mitigate the hammer noise effects generated within the breaker by controlling and absorbing noise at source. Through considerable research, the conclusion was made that a significant majority of the noise was generated within the breaker unit itself rather than the pick hitting the concrete.

**NEW**

- Custom manufactured to suit various attachments ranging from 3 - 100T in size
- Fire Retardant & Water Resistant
- Flexible, strong with optional cut-outs to accommodate for hydraulic hose's/ grease knuckle points
- Ripstop PVC coating for additional strength
- 100mm Velcro overlaps to ensure 100% noise barrier and minimal noise leakage points



Code

**HUSHRB**





## NOISE TESTING

### THIRD OCTAVE BAND SPECTRA FOR MEASUREMENTS

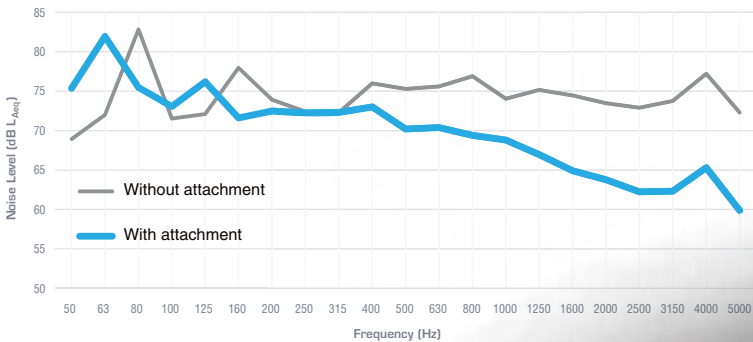

### MEASUREMENT RESULTS

Rock Breaker Attachment	Duration (m:ss)	Noise Level
On	6:25	78 dB LAeq
Off	7:35	86 dB LAeq

## ECO CLEANING PRODUCTS



VEGAN FRIENDLY  
PRODUCTS



CRUELTY FREE  
PRODUCTS



ECO FRIENDLY  
PRODUCTS



PLANT BASED  
INGREDIENTS



SEPTIC TANK  
SAFE



AQUATIC LIFE  
SAFE



**Naturewatch  
Foundation**

For the advancement of animal welfare



PET FRIENDLY  
PRODUCTS

### Eco Friendly Multi Surface Cleaner

- Powerful solution using natural plant extracts to lift away dirt and grime
- Formulated for a quick and easy clean
- Kills 99.9% bacteria
- Suitable to use on most hard surfaces
- 750ml



**CMT**   
think green

Code

ECOMSC750



12

### Eco Friendly Window & Glass Cleaner

- Removes stubborn dirt & marks from windows, glass & mirrored surfaces
- Fast dry action formula
- Smear & streak free clean
- 750ml



**CMT**   
think green

Code

ECOWGC750



12

### Eco Friendly Toilet Cleaner

- Removes limescale & water mark staining
- Deep cleans, freshens & sanitises
- Kills germs & bacteria
- 750ml



Code

**ECOTC750**



12

### Eco Friendly Washing Up Liquid

- Powerful foaming action that cuts through grease
- Long lasting concentrated formula
- Leaves dishes sparkling
- 500ml



Code

**ECOWU500**



12

### Eco Friendly Natural Hand Soap

- Neutralises 99.9% harmful bacteria
- Gentle on skin
- Food safe
- Suitable for domestic office and catering uses
- Sustainable naturally derived raw materials
- Hypoallergenic suitable for sensitive skin
- Readily biodegradable
- Exact packaging may vary
- 500ml



Code

**ECOHS500**



12

## INTRODUCING AQUAPAX WATER

Sealed and protected from light and air, in wholly recyclable, safely reusable, sustainably produced, non-leaching paper cartons, means Aquapax elevates itself above the ongoing war on plastic: it makes Aquapax unique in the market.

Most of our wholly recyclable carton material is paperboard made from trees, sourced from sustainable FSC Certified forests. Our 500ml cap is made from sugar cane, a natural plant that just grows back!

Multi-award winning Aquapax is also one of the purest waters in the world and the ever-increasing consumer demand for convenient, pure, additive-free, portable drinking water, is clear! Hence our passion for Aquapax.



## ONE OF THE PUREST WATERS IN THE WORLD.



**Aquapax Spring Water Cartons**

- The recyclable alternative to plastic bottles
- Packs of 12
- 500ml



**NEW**

Code

**AQUA50012**



105

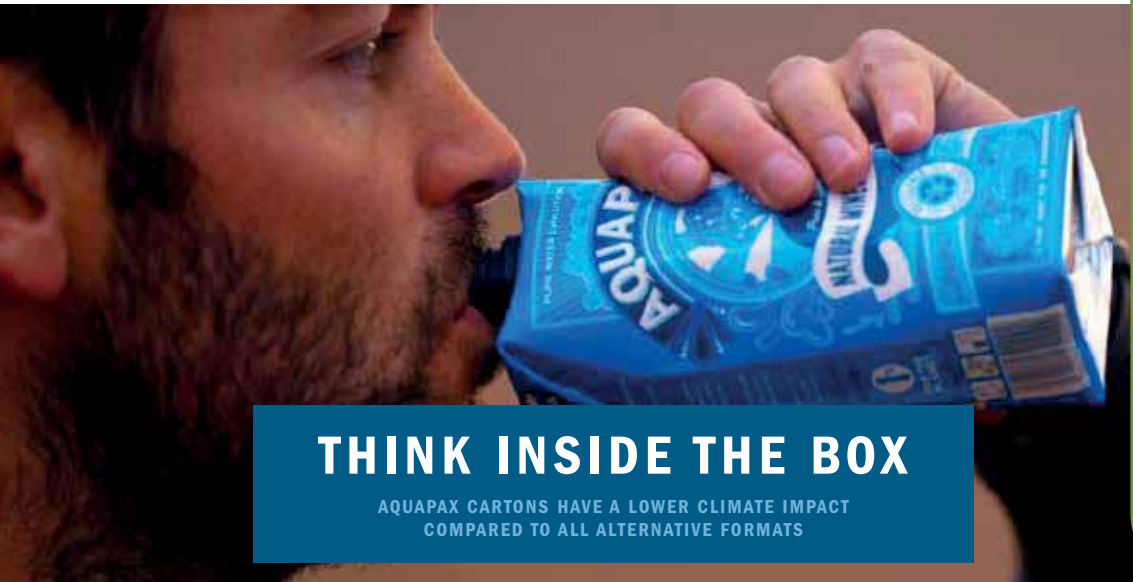

**THINK INSIDE THE BOX**

AQUAPAX CARTONS HAVE A LOWER CLIMATE IMPACT COMPARED TO ALL ALTERNATIVE FORMATS

**A**

**Sustainable**

AQUAPAX carton strength is from renewable FSC timber sources

**B**

**Plant Based**

By weight, AQUAPAX contains at least 62% plant-based material

**C**

**Recyclable**

The whole AQUAPAX carton can be recycled into useful new products

## ECO CUTLERY & CUPS

### Wooden Cutlery

- Eco friendly alternative to plastic
- Packs of 100

NEW



CMT  
think green 

Code



<b>WDNKNIF</b>	Knives	10
<b>WDNDESP</b>	Dessert spoons	10
<b>WDNFORK</b>	Forks	10
<b>WDNTASP</b>	Teaspoons	10
<b>WDNS1000</b>	Stirrer	10

### Paper Drinking Cups

- Compostable & biodegradable
- 8oz single wall
- Box of 1000

NEW



CMT  
think green 

Code



COMCUP8

1

# FIRE, ACCIDENT & EMERGENCY



First Aid	246-248
Aerowash Eyewash	249
Defibrillator	249-251
Clinical Waste & Sharps Disposal	252
Fire Equipment	253-257
Site Safety Stations	258

**FIRST AID**

**First Aid Kits**

- Supplied in a robust polypropylene green case
- Supplied with wall hanging bracket
- HSE compliant filling
- Refills available



Code		
<b>HSFAK05</b>	1 - 5 persons	20
<b>HSFAK10</b>	10 persons	20
<b>HSFAK20</b>	20 persons	10
<b>HSFAK50</b>	50 persons	10

**1 Person Kit in Zipper Pouch**

- Provide for lone workers
- Convenient zip pouch
- HSE compliant filling



Code	
<b>HSFAK01</b>	50

**Van Kit**

- Aerokit® vehicle First Aid Kits in robust cases suitable for use in vehicles with comprehensive fillings. Compliant to the various regulations
- Orange case to indicate not to be removed from vehicle



Code	
<b>30RH2</b>	20



### Burn Safety Kit

- Use on injuries including burns, cuts, scrapes & abrasions



Code

HS90816



10

### First Aid Kit with 500ml Eyewash Solution

- 10 person



Code

HSFAK10EYE5



10

### Workplace First Aid Kits

- Small, Medium and Large kits available
- Supplied in a weatherproof wall mountable case
- Meets BS8599-1:2011
- Contains assorted dressings, bandages, plasters, gloves, wipes, scissors, safety pins and tape
- Refills available for each kit



Code

**AKWS** British Standard 86 pcs small kit



1

**AKWM** British Standard 128 pcs medium kit

1

**AKWL** British Standard 189 pcs large kit

1

**AKS-R** Small British Standard refill

1

**AKM-R** Medium British Standard refill

1

**AKL-R** Large British Standard refill

1

**FIRST AID**

**Aeroplast® Premium Fabric & Transparent Plasters**

- Wash proof
- Assorted
- Box of 100



HSFP100



HSWP100

Code		
HSWP100	Transparent	20
HSFP100	Fabric	20

**Antiseptic Cleansing Wipes**

- Sterile saline wipes
- 100 per box



Code		
HSAW100		24

**Aerostationery® A4 Accident Report Book**

- Designed to cover common stationery requirements applicable to the First Aid industry



Code		
AN1012		1

**First Aider & Coss Armband**



FAAB



COAB

Code		
FAAB		10
COAB		10

**Aerowash® Eye & Wound Irrigation & Solutions**



HSEW500



HSEW02025



30EWST21



HS81103

Code				
<b>HSEW02025</b>	Eyewash capsules	20 ml	Pack of 25	10
<b>HSEW500</b>	Eyewash solution	500 ml		10
<b>30EWST21</b>	Eyewash station	2 x 500 ml		10
<b>HS81103</b>	Eyewash pod station	10 x 20 ml		10

**Intelligent Public Access Defibrillator**

- Designed to be used by minimally trained individuals, the iPad SP1 is suitable for use almost anywhere that people gather
- Easily switch from Adult to Child mode without changing the electrode pads
- Safety cover prevents accidental switching
- Smaller child pads also available as an option
- Integrated pad storage - electrode pads are stored, pre-connected, in a clear compartment on the underside of the unit



Code				
<b>NF1200A</b>				5

# YOUR BEST FIGHTING CHANCE

Are you prepared for Cardiac Emergencies?

Lifesaving, **Pure and Simple**



**HEARTSINE® DEFIBRILLATORS**  
The perfect blend of Quality and Price

## The best things in life are often simple.

That's true for the best lifesaving technology as well. The simple truth is that SCA strikes from 7 million people a year worldwide with no warning. There's little time to react and even less time to think.

So your AED solution must be close at hand, reliable and effective.

### Defibrillators Save Precious Minutes

Because every second counts

Every minute that passes without defibrillation reduces survival rate by 7–10%  
**Increase The Chance**



## DID YOU KNOW?

13% of workplace fatalities are from Sudden Cardiac Arrest (SCA)

# HEARTSINE DEFIBRILLATOR PRICING



HeartSine Samaritan 360P

**Fully Automatic Defibrillator**  
with CPR Metronome,  
visual and voice prompts



HeartSine Samaritan 500P

**Semi-Automatic Defibrillator**  
with CPR Metronome,  
visual and voice prompts and patient  
specific CPR feedback

## INCREASE THE CHANCE Your Complete Site Package

The Defibrillator + Carry Case + Internal Wall Cabinet + AED Prep Kit + Signage



• EASY TO USE • FASTEST TIME TO FIRST SHOCK • HIGHEST INDUSTRY IP RATING OF IP56  
DELIVERS A LIFESAVING SHOCK IN MORE CASES THAN ANY OTHER DEFIBRILLATOR.

Code

**HS360P** HeartSine 360P Package  
**HS500P** HeartSine 500P Package



1  
1

**CLINICAL WASTE & SHARPS DISPOSAL**

**AEROHAZARD® SHARPS & MEDICAL WASTE PRODUCTS**

A wide range of waste disposal containers which are designed to meet user's demands for strength, simplicity & value. This range offers outstanding protection against penetrating sharps & leaking fluids due to its rigid polypropylene construction & wall thickness. Assembly is fast & permanent; simply press the lid around the rim of the container until it snaps into place. A simple closure mechanism allows single handed disposal & most items have a temporary & permanent closure feature.

**Single Sharps  
Needle Disposal System**



Code

HS51060



10

**Sharps  
Disposal Kit**

- Contains 5 applications



Code

HS51062



10

**Sharpsafe  
Bins**

- Rigid containers for the safe disposal of contaminated sharps



HS51065



HS51066



HS51069

Code

HS51065 0.6 litre

HS51066 2.5 litre

HS51069 22 litre



1

1

1

**FIRE EXTINGUISHER SELECTION CHART**

Extinguisher type	CLASS A	CLASS B	CLASS C	ELECTRICAL
	Paper, Wood, textiles etc.	Flammable liquids e.g. petrol, oil etc.	Flammable gases e.g. butane & propane	Electrical Equipment
<b>WATER</b>	✓			
<b>FOAM</b>	✓	✓		
<b>CO<sub>2</sub></b>		✓		✓
<b>POWDER</b>	✓	✓	✓	

**FIRE EQUIPMENT**

EXTINGUISHER  
SERVICING &  
MAINTENANCE  
AVAILABLE



**DON'T FORGET**

CALL 020 8311 1144

**FIRE SAFETY SIGNS**

FOR OUR RANGE  
OF SIGNS  
GO TO PAGES  
482-483



**HAVE YOU SEEN?**

**FIRE EQUIPMENT**

**Powder Extinguisher Range**

- Corrosion resistant finish
- Protective plastic base with 4, 6, 9kg
- CE marked
- Lloyds Register certified



Code		
FRP1	1 kg	1
FRP2	2 kg	1
FRP4	4 kg	1
FRP6	6 kg	1
FRP9	9 kg	1

**Foam Extinguisher Range**

- Spray nozzle
- Corrosion resistant finish
- Internal polyethylene lining
- Protective plastic base
- CE marked
- Lloyds Register certified



Code		
FRF2	2 Litre	1
FRF6	6 Litre	1
FRF9	9 Litre	1

**Water Extinguisher Range**

- Corrosion resistant finish
- Internal polyethylene lining
- Protective plastic base
- CE marked
- Lloyds Register certified



Code		
FRW6	6 Litre	1
FRW9	9 Litre	1

**CO<sub>2</sub> Extinguisher Range**

- CE marked
- Aluminium cylinder
- Powder coated corrosion resistant finish
- Lloyds Register certified



Code		
FRC02	2 kg	1
FRC05	5 kg	1



**Double Fire Extinguisher Trolley**

- Trolley only - extinguishers supplied separately
- Takes 2 x 9kg/9L extinguishers
- Complete with bell



Code



**FRTROLL**

1

**Construction Fire Safety Point**

- Heavy duty steel construction for maximum strength
- Can be used with extinguishers up to 200mm diameter
- Fire buckets accommodated using bucket bracket kit
- Extinguishers, Signage & Site Alarm supplied separately
- Height 150cm, Width 66.5cm, Depth 38cm
- Capacity 3 x 9kg/9l extinguishers & accessories



Code



**CONSTRUCTS**

1

**Fire Extinguisher Stand Standard Duty**

- Stand only - extinguishers supplied separately



Code



**DESRED**

1

**Fire Extinguisher Stand Heavy Duty**

- Stand only - extinguishers supplied separately



Code



**DESREDHD**

1

**FIRE EQUIPMENT**

**Fire Blanket**

- Hinged lid for easy extraction
- Moulded keyhole for added strength when hanging
- Kitemark certified to BSEN 1869:1997



Code		
<b>FRBL66</b>	6" x 6"	10
<b>FRBL44</b>	4" x 4"	20

**Galvanised Steel Fire Bucket**

- Complete with lid
- Sand not included



Code	
<b>FRBKT</b>	1

**Air Horn**

- 500ml



Code	
<b>AH500</b>	24

**Break Glass Site Alarm**

- Self-contained alarm unit
- Indoor/outdoor applications
- 118db siren
- Durable polypropylene container



Code	
<b>FRSHAL</b>	1

**Smoke Alarm**



Code	
<b>FRSMAL</b>	6

**Push Button Alarm**

- 200mm x 300mm x 120mm
- White/Red
- Self-contained, battery operated fire alarm
- Equipped with 105db siren
- 185mm x 315mm x 100mm
- Push Button or Break Glass versions available



Code	
<b>FSH01</b>	6

**Fire Hose**  
**2½"**

- 23 metre



Code

**FH21223**



2

**Rotary**  
**Fire Bell**



Code

**FRBELL**



20

**Standpipe**  
**Key**

- 1 ¼" AF fitting
- 16mm diameter bar

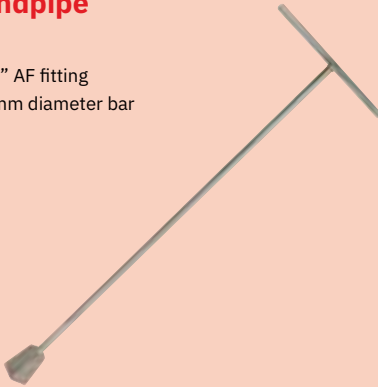

Code

**SPKEY**



1

**Standpipe**  
**Single Head**

- Non return valve
- Galvanised tube, brass bibtap and 3/4" hose union.



Code

**SP100**



1

**Stopcock**  
**Key**

- 42" length
- 16mm diameter bar

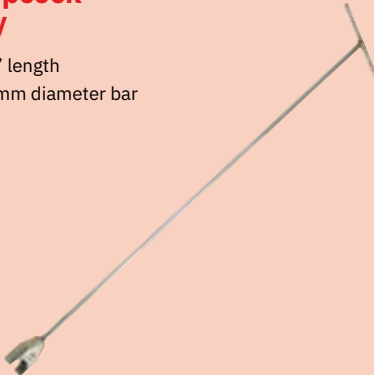

Code

**FRSCK01**



1

# SITE SAFETY STATIONS

## MAX Site Safety Stations

CALL FOR MORE DETAILS & PRICES

- Customisable, branding available
- Board options include spill kit station, first aid point, fire point and information point
- 1, 3 or 4 board configurations

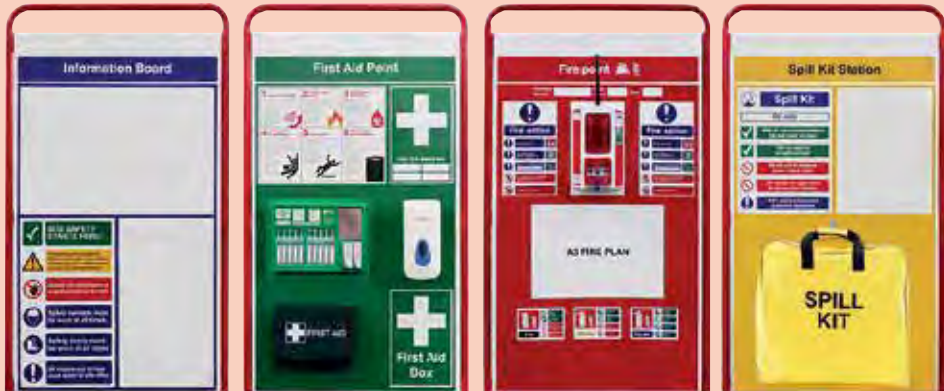

Code		No. of boards
MAXSTATION-1-INFO	Information point only	1
MAXSTATION-1-FA	First aid point only	1
MAXSTATION-1-SK	Spill kit point only	1
MAXSTATION-1-FIRE	Fire point only	1
MAXSTATION-1-INFISK	Information point, fire point and spill kit point	3
MAXSTATION-1-FASKIN	First aid point, spill kit point and information point	3
MAXSTATION-1-FASKFI	First aid point, spill kit point and fire point	3
MAXSTATION-1-FAINFI	First aid point, information point and fire point	3
MAXSTATION-1-FFIS	Fire point, first aid point, information point and spill kit point	4

# PERSONAL PROTECTIVE EQUIPMENT



Safety Footwear	260-275
Hand Protection	276-291
Hearing Protection	292-297
Eye & Face Protection	298-307
Respiratory Equipment	308-319
Head Protection	320-325
Helmet Accessories	326-327
Fall Arrest & Restraint	328-330

**SAFETY FOOTWEAR**

**FOOTWEAR SIZE GUIDES**

<b>EURO</b>	<b>37</b>	<b>38</b>	<b>39</b>	<b>40</b>	<b>41</b>	<b>42</b>	<b>43</b>	<b>44</b>	<b>45</b>	<b>46</b>	<b>47</b>	<b>48</b>
<b>UK</b>	<b>4</b>	<b>5</b>	<b>6</b>	<b>N/A</b>	<b>7</b>	<b>8</b>	<b>9</b>	<b>10</b>	<b>N/A</b>	<b>11</b>	<b>12</b>	<b>13</b>











**KEY TO EN ISO 20345  
FOOTWEAR CLASSIFICATIONS**

- SB** Basic minimum standard. 200 joule toecap no midsole
- S1** As SB plus anti-static properties & energy absorbing heel
- S2** As S1 plus water penetration & water absorption resistance
- S3** As S2 plus pierce resistant & cleated outsole
- S4** 200 joule toecap protection, all rubber or polymeric footwear with anti-static & energy absorption of seat region
- S5** As S4 plus penetration resistance and cleated outsole
- P** Sole penetration resistance via a protective midsole (this symbol not required on S3)
- M** Metatarsal protection
- NM** Non-metallic
- WP** Water penetration
- WR** Water resistant
- CI** Insulation against cold
- HI** Insulation against heat
- HRO** Heat resistant

**SLIP TESTING**

- SRA** Footwear slip tested on ceramic tile with sodium lauryl solution
- SRB** Footwear slip tested on steel floor with glycerol
- SRC** Footwear slip tested on both of the above

**KEY TO SYMBOLS**

 Leather Upper	 Nubuck Leather Upper	 SRC Rated	 S3 Rated	 200J Rated Toe Cap	 Composite Toe Cap	 Aluminium Toe Cap	 Steel Protective Midsole	 Kevlar Protective Midsole	 Protective Midsole Rating 1100N
 Oil Resistant Sole	 Heat Resistant Sole to 300°C	 Water Repellent	 WR Rated Water Proof	 Anti-Static	 Metatarsal Protection	 Lace Fastening	 Breathable Lining	 Anti-Fatigue Footbed	 100% Non Metallic

## MAX MX18-MT Metatarsal Protection Safety Boot

NEW

- 100% non-metallic
- Waterproof and breathable WR rated
- Metatarsal protection made from XRD® M-Guard, M rated
- Composite 200J toe cap provides falling object protection to 200 joules
- Sizes: UK 6-12

**MAX**<sup>TM</sup>  
QUALITY.  
UNMATCHED.

### RESISTANT RUBBER SOLE

Rubber injected sole unit, heat resistant to 300°C with increased resistance to solvents and alkalis



### COMFORT INSOLE

Feels comfortable and provides a high level of shock absorption



### METATARSAL PROTECTION

M-rated for extra protection from drop hazards

### EXTRA PROTECT SCUFF CAP

Composite toe cap, resistant to 200 Joules of pressure



Code

MX18



1

ORDER 6AM TO 7PM FOR NEXT MORNING DELIVERY

Set up an account for our discounted rates / prices

261

SAFETY FOOTWEAR

**MAX MX15 Scuff Pro Comfort+ Gel Insole Safety Boot - Black**

- EN ISO 20345; 2011 S3 HRO
- Buffalo leather
- Comfort plus innersole
- Extra protect scuff cap
- 300°C heat resistant sole
- Breathable lining
- Sizes: UK 6-13



**BEST SELLER**

**COMFORT INSOLE**  
Feels comfortable and provides a high level of shock absorption



**BUFFALO® FULL GRAIN LEATHER**  
Resistant to water penetration and absorption, looks smart and is very durable

**RESISTANT RUBBER SOLE**  
Rubber injected sole unit, heat resistant to 300°C with increased resistance to solvents and alkalis



**BREATHABLE LINING**  
Insulated to -17°C

**EXTRA PROTECT SCUFF CAP**  
Steel toe cap, resistant to 200 Joules of pressure



Code  
MX15

1



## MAX MX12 Comfort+ Gel Insole Safety Boot - Honey

- EN ISO 20345
- SRA slip rating
- S3 safety rating
- Honey Nubuck
- EVA rubber sole
- Mesh anti bacterial innersole
- Composite toe cap
- Kevlar midsole
- Sizes: UK 6 - 13

**MAX**<sup>TM</sup>  
QUALITY.  
UNMATCHED.

**EVA RUBBER SOLE**  
REVA rubber sole provides anti-fatigue properties for the wearer



**COMFORT INSOLE**  
Feels comfortable and provides a high level of shock absorption

**100%**  
NON -  
METALLIC



**HONEY NUBUCK LEATHER**  
Smart and durable for constant site use. Water repellant upper



**KEVLAR MIDSOLE**  
Ensures total protection against midsole penetration



Code

MX12



1

ORDER 6AM TO 7PM FOR NEXT MORNING DELIVERY

Set up an account for our discounted rates / prices

## SAFETY FOOTWEAR

### Titanium Safety Boot



100%  
NON -  
METALLIC



- EN ISO 20345:2011 S3 HI CI WR HRO SRC
- Premium full grain waxy leather
- Comfort lining
- Waterproof Activ-Tex®
- Heat resistant to 300°C
- R-ten™ abrasion resistant thread
- Force10® GR100 solid nitrile rubber
- Sizes: UK 3 - 14



Code

RF4500



1

### Slate Safety Boot



- EN ISO 20345:2011 S3 WR HRO SRC
- Premium full grain waxy leather
- Force10® components
- Heat resistant to 300°C
- Activ-Tex® waterproof & breathable membrane
- Sizes: UK 3 - 15



Code

RF460



1

### Waterproof & Breathable Boot



100%  
NON -  
METALLIC



- EN ISO 20345:2011 S3 SRC WR
- EVA anti-fatigue footbed
- Activ-Step® double density PU outsole for durability
- Activ-Tex® waterproof & breathable membrane
- Increased comfort padding on collar & tongue
- Sizes: UK 6 - 12

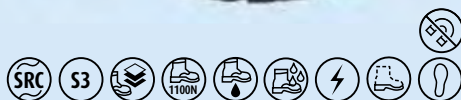

Code

PM4008



1

### V-Tech Storm Hiker



- EN ISO 20345 S3 SRB HRO
- Steel toecap & midsole
- Heat resistant to 300°C
- Oil resistant sole
- Anti-static
- Waterproof & breathable
- Anti-slip traction
- Sizes: UK 7 - 12



Code

V1219



1

### Chukka Boot with Scuff Cap

- EN ISO 20345:2011 S1P
- Steel toecap & midsole
- Scuff cap
- Anti-static & anti-slip
- Oil resistant
- Sizes: UK 6 - 13



Code

FWSCB



1

### Chukka Boot

**ProMan**  
INDUSTRY DEFINING SAFETY FOOTWEAR

- EN ISO 20345:2011 S3 SRC
- Steel toecap & midsole
- Anti-static & anti-slip
- Oil resistant
- Sizes: UK 6 - 13



Code

PM100



1

### Rhyolite Metatarsal Boot

**Rock Fall**  
INDUSTRY DEFINING SAFETY FOOTWEAR

100%  
NON-METALLIC

- EN ISO 20345:2011 S3 M NM WP
- Composite toecap & midsole
- Metatarsal protection
- Anti-static & anti-slip
- Water resistant
- Heat resistant to 300°C
- Oil resistant
- R-ten™ abrasion resistant thread
- Sizes: UK 5 - 14

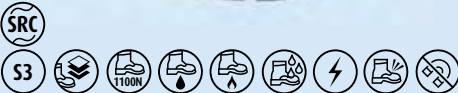

Code

TC3000A



1

### Premium Steel Toe Boot with Steel Mid Toe

**ProMan**  
INDUSTRY DEFINING SAFETY FOOTWEAR

- EN ISO 20345; 2011 S3 SRC
- Water repellent
- Smooth black leather
- Protective steel toecap
- Stainless steel anti-penetration midsole
- Sizes: UK 7 - 13



Code

RFPM4002



1



**18kV**

Disclaimer: This footwear is Electrical Hazard (EH) tested in accordance with the test method ASTM F2413-18. Protection deteriorates rapidly in damp and wet environments and with wear. EH footwear is intended as secondary source protection equipment.

# Rock Fall®

INDUSTRY DEFINING SAFETY FOOTWEAR

SAFETY FOOTWEAR DESIGNED WITH AN INSULATING SOLE UNIT (ELECTRICAL HAZARD)

# RF160 OHM

EN ISO 20345:2011  
SB P E WRU FO SRC  
ASTM F 2413-18 EH

SIZE: UK 6-12



**18kV EH Rated**  
**Fully Non-Metallic | Boa® Lifetime of Boot Guarantee**



## Rockfall RF160 OHM Safety Boot

- EN ISO 20345:2011
- Protective toe cap and midsole
- BOA® fit system
- Can withstand electrical risks of 1.8kV
- EVA nitrile rubber outsole
- Ortholite® climate breathable footbed
- Sizes: UK 6 - 12

**RockFall®**  
INDUSTRY DEFINING SAFETY FOOTWEAR



NEW



Code

RF160



1

## StormHi 8" Waterproof Safety Boot - Honey

- EN ISO 20345:2011
- Composite toe cap & midsole protection
- Full grain waterproof leather uppers
- Moisture wicked Air-Tex lining + waterproof membrane
- SRC slip resistance
- Sizes: UK 6 - 12



NEW



Code

ST5211HY



1

ORDER 6AM TO 7PM FOR NEXT MORNING DELIVERY

Set up an account for our discounted rates / prices

## SAFETY FOOTWEAR

### Flint Boot - Black



100%  
NON -  
METALLIC

- EN ISO 20345:2011 S3
- Composite toecap & zero penetration midsole
- Phylon & rubber outsole providing enhanced durability
- Sports padded collar for increased support & comfort
- EVA anti-fatigue footbed
- Water repellent upper & abrasion resistant internal heel counter
- Sizes: UK 7 - 12



Code  **RF440A** Black 1

### Flint Boot - Honey



100%  
NON -  
METALLIC

- EN ISO 20345:2011 S3
- Composite toecap & zero penetration midsole
- Phylon & rubber outsole providing enhanced durability
- Sports padded collar for increased support & comfort
- EVA anti-fatigue footbed
- Water repellent upper & abrasion resistant internal heel counter
- Sizes: UK 7 - 12



Code  **RF440C** Honey 1

### Fully Non-Metallic Safety Boot



100%  
NON -  
METALLIC

- EN ISO 20345:2011 S3 SRC WP
- Composite toecap & protective composite midsole
- PU moulded scuff cap for highest durability
- EVA anti-fatigue footbed
- Moisture wicking tibrelle lining
- Sizes: UK 6 - 13

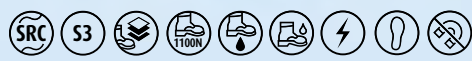

Code  **PM600** 1

### Dealer Boot - Leather



- EN ISO 20345:2011 S1P SRC
- Steel toecap & midsole
- Anti-static & anti-slip
- Oil resistant
- Full grain leather
- Sizes: UK 7 - 12
- (other sizes available to order)



Code  **FWDBLK** 1

## Maine Safety Trainer - Non-Metallic

**Rock Fall**  
INDUSTRY DEFINING SAFETY FOOTWEAR

100%  
NON -  
METALLIC

- EN ISO 20345:2011 S1P SRC
- Protective toecap & midsole
- Comfortable and lightweight
- Activ-Step® pu anti-fatigue comfort footbed
- Sizes: UK 7 - 11



Code



TC130

1

## Dakota Safety Boot - Non-Metallic

**Rock Fall**  
INDUSTRY DEFINING SAFETY FOOTWEAR

100%  
NON -  
METALLIC

- EN ISO 20345:2011 S3 SRC NM HRO
- Lightweight hiker styled safety boot
- Sports comfort footbed
- Sports cushioning ankle for ultimate support
- Cut out 'Y' collar for extra comfort
- Rubber outsole Heat resistant to 300°C
- Sizes: UK 6 - 13



Code



TC340A

1

## V-Tech Rigger Boot

**V12**  
FOOTWEAR

- EN ISO 20345:2011 S1P SRC
- Steel toecap & midsole
- Oil resistant
- Anti-static
- Fur lining provides cold insulation
- Sizes: UK 8 - 12



Code



FWVR

1

## Tan Leather Rigger Boot

**ProMan**  
INDUSTRY DEFINING SAFETY FOOTWEAR

- EN ISO 20345:2011 S3 SRC
- Buffalo smooth leather
- Steel toecap & midsole
- Heat resistant to 300°C
- Anti-static & anti-slip
- Oil resistant
- Fur lining provides cold insulation
- Sizes: UK 7 - 12 (other sizes available to order)



Code



PM104

1

## SAFETY FOOTWEAR

### Safety Brogue Shoe

- EN ISO 20345:2011 S1 SRC
- Steel toecap & midsole
- Full grain leather
- Oil resistant
- Anti-static
- Slip resistant sole
- Sizes: UK 7 - 12



Code

FWBBS



1

### Boot Bag

BRAND

- 28 litre
- Navy blue
- Complete with ID holder



Code

QUADB



1

### Activ-Step Deluxe Footbed Insoles

- Anti-fatigue
- Increased arch support
- Cuts down to exact size



Code

ATFI-09 UK size 9

1

ATFI-10 UK size 10

1

ATFI-11 UK size 11

1

ATFI-12 UK size 12

1

### Extreme Cold Weather Socks



Code

SK18



1



**Vixen Emerald**

- EN ISO 20345; 2011 S1P
- Steel toe cap & midsole
- Premium leather upper
- EVA anti-fatigue footbed for increased comfort
- Dual density outsole
- Anti-static properties
- Lightweight & flexible
- Black
- Sizes: UK 3-7



**Rock Fall®**  
INDUSTRY DEFINING SAFETY FOOTWEAR



Code

**VX500**



**Vixen Onyx - Honey**

- EN ISO 20345; 2011 S3 WR HRO SRC
- Fibreglass toe cap & composite midsole
- Genuine honey nubuck
- Waterproof Activ-Tex®
- Women's fit
- Sizes: UK 3-8



**Rock Fall®**  
INDUSTRY DEFINING SAFETY FOOTWEAR

**100%**  
NON - METALLIC



Code

**VX950C**



**FOR OUR NEW WOMENS CLOTHING RANGE**

**HAVE YOU SEEN?**

SEE PAGES  
350-351



# a new era

## IN SAFETY FOOTWEAR

The Worlds first hi-visibility 360° safety boot, designed and manufactured with innovative technical performance in mind to create, the most comfortable safety boot available today, that can withstand the harshest of working conditions.



STAY SAFE



STAY SEEN

### 360° HI VISIBILITY

In daylight, lowlight and at night:  
 EN ISO 20345 S5 HRO CI HI SRA  
 EN ISO 20471  
 RIS-3279-TOM  
 EN 1150



### HYDRO CONTROL

2mm airmesh network wicks saturated air to the exterior of the boot.

### 100% WATERPROOF

Fully waterproof to the very top of the boot.

### THERMAL DEFENCE

A boot for all temperatures including thermal protection down to -40°C.

### CRUSH PROTECTION

Fibre glass non-metallic toe cap: 200J EN 12568

### RESISTANT

Resistant to fuel oil and hydrocarbons.

### ANTI-FATIGUE

Designed for all day wear; supports natural posture and spinal alignment, reducing wear and tear on lumbar vertebrae.

### STABILITY & ANTI-SLIP

Excellent stability on rough/uneven ground. Superb grip on typically hazardous surfaces such as wet rock and wooden sleepers.

### PIERCE PROTECTION

Flexible Kevlar non-metallic penetration resistant midsole: 1100N EN 12568

MOISTURE WICKING

ANTI-SLIP

ANTI-STATIC

ANTI-CLOG

ARCH SUPPORT

SHOCK ABSORPTION



Brightboot Low

Brightboot Mid

Brightboot Tall

### Brightboot Tall Safety Boot

• Sizes: UK 8 - 13

**NEW**



Code



**FWBBTY** Yellow  
**FWBBTO** Orange

1  
1

### Brightboot Mid Safety Boot

• Sizes: UK 8 - 13



Code



**FWBBMY** Yellow  
**FWBBMO** Orange

1  
1

### Brightboot Low Safety Boot

• Sizes: UK 8 - 13



Code



**FWBBLY** Yellow  
**FWBBLO** Orange

1  
1

**SAFETY FOOTWEAR**

**Safety Chest Waders**



- EN ISO 20345:2011 S5
- Steel toecap & midsole
- Waterproof
- Oil resistant
- Anti-static & anti-slip
- Sizes: UK 7 - 12



Code



**FW74**

1

**Safety Thigh Waders**



- EN ISO 20345:2011 S5
- Steel toecap & midsole
- Waterproof
- Oil resistant
- Anti-static & anti-slip
- Sizes: UK 7 - 12



Code



**FW71**

1

**Safety Wellington Boot**



- EN ISO 20345:2011 S5
- Steel toecap & midsole
- Waterproof
- Channelling for increased liquid dispersal
- Oil resistant
- Anti-static
- Sizes: UK 6 - 13



Code



**FWWB**

1

**Heavy Duty Safety Wellington Boot**



- EN ISO 20345:2011 S5
- Steel toecap & midsole
- Waterproof
- Washable nylon lining
- Oil resistant
- Anti-static
- Anti-slip
- Kick-off spurs for easy removable
- Sizes: UK 6 - 12



Code



**FWHDB**

1

## Rock Fall Silt Neoprene Safety Wellington

- EN ISO 20345:2011 S5 CI HRO SRC
- Protective fibreglass toecap
- Anti-penetration flexi-midsole
- Enhanced thermal properties
- Comfort footbed
- Waterproof
- Durable rubber outsole
- Rubber sole
- Sizes: UK 6 - 13

**Rock Fall**<sup>®</sup>  
INDUSTRY DEFINING SAFETY FOOTWEAR

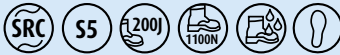

Code

RF290



1

## Dunlop Wellingtons

**DUNLOP**

- EN ISO 20345:2011 S5 SRA
- Steel tipped toe
- Steel midsole
- Waterproof
- Ideal for general tasks
- Sizes: UK 6 - 13

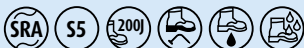

Code

FWWBDLP



1

## Dunlop - ACI Capped Wellingtons

**DUNLOP**

- EN ISO 20345:2011 SB P FO SRA
- Steel tipped toe
- Midsole protection
- Waterproof
- Oil resistant outersole
- Actifort full safety
- PVC/Nitrile rubber
- Sizes: UK 6 - 12



Code

DUN-ACI



1

HAND PROTECTION

# GLOVE TYPE GUIDE

## European Standards

Implies that the glove comply with the basic requirements laid down by the EC Regulation: Personal Protection Equipment.

### Simple Design (Category I)

For areas of 'minimal risks' where the effects of not wearing a glove are easily reversible or superficial. Such products are self-certified.

### Intermediate Design (Category II)

For areas of 'specific risks' i.e. mechanical risks. Such products would have been EC type tested against European test methods and certified by a notified body.

### Complex Design (Category III)

For areas/application that can seriously or irreversibly harm the health. Such products, in addition to the CE type test, will also have to be either produced under an approved quality system or be tested on an annual basis

## CE Safety Standard Symbols - What to look out for

Each glove has its own individual rating for each standard it qualifies for. Against each product there will be standards symbols where appropriate, clearly displaying the particular safety standards that the glove complies with. This will help you quickly see what you need to know about the glove, helping you shop more efficiently.

### What the numbers represent

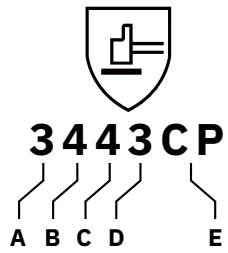

### Mechanical Hazards: EN388

- A** - Abrasion resistance **0-4**
- B** - Circular blade-cut resistance **0-5**
- C** - Tear resistance **0-4**
- D** - Puncture resistance **0-4**
- E** - Straight blade cut (TDM) resistance A-F (f)  
Impact resistance P if passes

### Performance Level

-  **EN388**  
**PROTECTIVE AGAINST MECHANICAL RISKS**
-  **EN374-2**  
**BIOHAZARD RESISTANT**
-  **EN374-3**  
**CHEMICAL RESISTANT**
-  **EN407:2004**  
**THERMAL HAZARD PROTECTION**
-  **ISO 10819**  
**MECHANICAL VIBRATION & SHOCK**
-  **EUROPEAN CONFORMITY**

An "X" can be shown in place of any of the first 5 digits underneath the pictogram, where the test was either not carried out, not required or not suitable.



## CUT RESISTANT

Protects hands from sharp tools or objects



## PUNCTURE RESISTANT

Protection against getting pierced or pricked



## COLD PROTECTION

Protects hands when handling cold objects



## DISPOSABLE

Protection against cross contamination



## MECHANICS

Protects hands in general assembly environment



## ANTI-IMPACT

Protection against impact damage



## TOUCH-SCREEN

Enables you to use a touch screen device



## CHEMICAL RESISTANT

Protection from harmful chemicals/substances



## GENERAL PURPOSE

Protects hands when performing general tasks



## ELECTRICAL PROTECTION

Protects the wearer from electric shocks



## HEAT/FLAMES/ARC PROTECTION

Protection when handling hot objects



## ANTI-VIBRATION

Protects hands from vibration



## WATER RESISTANT

Protection in wet conditions

### Changes to EC standard EN 388

During 2016 a new version of EN 388, Protection against Mechanical Hazards, was published. It allows products offering higher classifications of cut levels to be identified.

### What has changed

Any sample tested for cut resistance using the existing coup method, which blunts the blade used in the test, will have to be additionally tested using the ISO cut method. There will be 6 cut levels defined on the ISO cut method. Levels A, B and C are new. Level D is of a different value to the level previously quoted as 4. Level E is the same value previously quoted as level 5. Level F is also new and is the highest cut resistance value.

Level A	Level B	Level C	Level D	Level E	Level F
2	5	10	15	22	30

Back of hand protection (impact protection testing) is now included.

**3** - Means the sample achieved level 3 for abrasion

**4** - Means the sample achieved level 4 for coup cut

**4** - Means the sample achieved level 4 for tear

**3** - Means the sample achieved level 3 puncture

**C** - Means the sample achieved level C for ISO cut which was tested due to blade blunting during the coup test

**P** - Means the sample passes requirements for impact protection

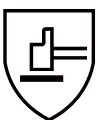

## 3443CP



**MAX**<sup>TM</sup>  
QUALITY  
UNMATCHED



CE

10/XL

2231

**MAX**<sup>TM</sup>

**QUALITY,  
UNMATCHED.**



### Heavy Duty Latex Grip Gloves



- Sizes: M, L, XL, XXL (8, 9, 10, 11)
- Pack of 12



HEAVY DUTY GRIP

BEST SELLER



Code

GGHD



120

### Latex Grip Gloves



- Sizes: M, L, XL, XXL (8, 9, 10, 11)
- Pack of 12



GRIP

BEST SELLER



Code

GGGN



120

### Thermal Grip Gloves



- Sizes: L, XL, XXL (9, 10, 11)
- Pack of 12



Code

SGGT



120

### MP1 Grab & Grip Safety Gloves



- Sizes: M, L, XL, XXL (8, 9, 10, 11)
- Pack of 12



Code

GGMP1



100

HAND PROTECTION

Foam Latex Waterproof Gloves

- Flexible robust glove giving great dexterity
- Good cut & tear resistance
- Fully coated waterproof finish
- Perfect for working with concrete and other heavy handling
- Double coated latex
- Sizes: L, XL, (9, 10)
- Pack of 12



Code  
MAXWR100



Foam Latex Waterproof Thermal Gloves

- Flexible robust glove giving great dexterity
- Good cut & tear resistance
- Fully coated waterproof finish
- Perfect for working with concrete and other heavy handling
- Thermal lining for cold weather use
- Sizes: L, XL (9, 10)
- Pack of 12



Thermal lining



Code  
MAXTHERM100



### Foam Nitrile Gloves - Palm Coated

- Seamless liner for comfort
- Snug fit - maximum dexterity
- Foamed nitrile coating ensures excellent wet grip
- Palm coated for breathability
- Sizes: L, XL, XXL (9, 10, 11)
- Pack of 12



**BEST SELLER**



Code

SFNGPC



120

### Foam Nitrile Gloves - Fully Coated

- Seamless liner for comfort
- Snug fit - maximum dexterity
- Foamed nitrile coating ensures excellent wet grip
- Fully coated
- Sizes: L, XL, XXL (9, 10, 11)
- Pack of 12



Code

SFNGFC

144

### Grip It SL - Sponge Latex Coated Gloves

- The soft seamless knitted yarn provides an excellent level of comfort, whilst the open back style allows the hand to breathe
- The breathable seamless liner combined with the soft sponge latex coating provides outstanding dexterity and a snug fit
- The soft sponge latex coating offers excellent dry grip for safe and secure handling
- Pack of 12



Code

<b>SL8896</b>	Size 9	60
<b>SL8897</b>	Size 10	60
<b>SL8898</b>	Size 11	60

HAND PROTECTION

**Nitrile Gloves**

- Sizes: M, L, XL, XXL (8, 9, 10, 11)
- Pack of 12



Code

**SNG**



120

**Nitron Lite Gloves**

- Comfortable natural cotton
- Lightweight flexible nitrile coating
- Textured surface
- Sizes: XL (10) only
- Pack of 12



3111X

Code

**SNLY-10**



48

**Nitron Extra Light Blue Gloves**

- Comfortable natural cotton
- Lightweight flexible nitrile coating
- Textured surface
- Sizes: XL (10) only
- Pack of 12



3111X

Code

**SNLB-10**



240

**Matrix Nitrile Gloves**

- Seamless liner for extra comfort
- Lightweight full nitrile coating offers excellent flexibility
- Elasticated knit wrist for snug fit
- Provides excellent dry grip
- Sizes: XL (10) only
- Pack of 12



3121X

Code

**SMNFC-10**



120

**Nitron Fully Coated Gloves (with Knit Wrist)**

- Very heavy duty for rough materials handling
- Soft Jersey liner
- Excellent dry grip
- Sizes: XL (10) only
- Pack of 12



4221X

Code

**SNFCKW-10**



48

### PU Coated Gloves

- Cut level 1 (not colour coded)
- Knitted nylon glove with polyurethane coating
- Snug fit - maximum dexterity
- Open back for maximum breathability
- Sizes: M, L, XL, XXL (8, 9, 10, 11)
- Pack of 12



**BEST SELLER**

FROM ONLY **0.51**

EN388 2016



4131X



Code

SLG



120

### Matrix P-Grip Gloves

- Knitted liner with polyurethane coating
- Seamless for extra comfort
- Snug fit - maximum dexterity
- Good abrasion and tear resistance
- Black only
- Sizes: L, XL, XXL (9, 10, 11)
- Pack of 12



EN388 2016



3131X

Code

<b>402-MAT</b>	Size 8	144
<b>403-MAT</b>	Size 9	144
<b>404-MAT</b>	Size 10	144
<b>405-MAT</b>	Size 11	144

### Matrix Mechanics Gloves

- Reinforced palm grip patches
- Spandex on the back of the hand for comfort
- Neoprene on knuckles for extra protection
- Adjustable velcro wrist strap for extra protection
- Three open fingers for maximum dexterity
- Sizes: L, XL, (9, 10)
- Pack of 12



EN388 2016



2141X

Code

SMMG



10

## HAND PROTECTION

### Heavy Duty Double Palm Rigger Gloves



- Extra thick leather with double thickness green leather on palm, thumb and forefinger
- Soft fleece lining to palm and fingers
- Size XL, (10)
- Pack of 12



EN388  
2016



3121X

Code



SRGBL-10

100

### Heavy Duty Rigger Gloves



- Size: XL, (10)
- Pack of 12



EN388  
2016



3123X

Code



SRGBY-10

120

### Canadian Leather Rigger Gloves



- Sizes: XL (10) only
- Pack of 12



EN388  
2016



3223X

Code



SCRG-10

120

### Daytona Drivers Gloves



- High grade cow grain leather glove
- Available lined or unlined
- Sizes: L, XL, (9, 10)
- Pack of 12



EN388  
2016



3242X

Code



ULDG100 Unlined

50

DR100 Lined

50

### PVC MAX Knit Wrist Gloves

- Size: L, XL, (9, 10)
- Pack of 12



EN388



4121X

Code



SPVG

12

### Household Rubber Gloves

- Sizes: M, L, XL, (8, 9, 10)
- Pack of 12



Code



SLHR

120

### PVC Gauntlets

- Lengths: 270, 350 or 450mm (11, 14 or 18")
- Sizes: XL (10) only
- Pack of 12



Code



SPVGG11-10 270mm (11")

120

SPVGG14-10 350mm (14")

120

SPVGG18-10 450mm (18")

120

### Taskmaster Chemical Resistant Gloves

- Roughened hand surface for safer handling of both wet and dry objects
- Maximum abrasion score for EN388
- 100% cotton interlock liner for extra comfort and reduced hand fatigue
- Good insulation against heat and cold
- Protection against a wide range of chemicals and cleaning agents
- Sizes: L, XL, XXL (9, 10, 11)



EN388



4131X

EN374-3



EN374-2



Code



STLG

48

### PVC Coated Full Arm Length Gauntlets

- Cotton liner
- Length 640mm
- Excellent resistance to acids, alkalis and oils
- Sizes: S, L, XL, XXL (7, 9, 10, 11)
- Pack of 12



EN388



4121X

EN374-3



EN374-2



Code



SLJFAG

36

## HAND PROTECTION

### MAX Latex Gloves

- Latex palm guard
- Lightweight
- Sizes 9 & 10 available
- Pack of 12



EN388  
2016



2131X

Code



MXL

12

### MAX Nitrile Gloves

- Nitrile
- Lightweight
- Sizes 9 & 10 available
- Pack of 12



EN388  
2016



4131X

Code



MXN

12

### MAX PU Gloves

- PU
- Lightweight
- Sizes 9 & 10 available
- Pack of 12



EN388  
2016



3131X

Code



MXP

12

### PU300 Gloves

- PU palm coated
- Sizes 9 & 10 available
- Pack of 12



EN388  
2016



4343B

Code



PU300

12



### Cut Resistant Gloves

- Cut level 5 (not colour coded)
- Excellent resistance to abrasion and tear
- Elasticated knit wrist for a snug fit
- Sizes: L, XL, XXL (9, 10, 11)
- Pack of 12



Code

SCRSG

120

### Cut Resistant Sleeve

- Cut level 5 (not colour coded)
- Tubular sleeve - 56cm (22")
- Cut & heat resistance for wrist & arm area
- Thumb hole for secure fit
- Pack of 12



Code

MXCS

12

### PU500 Gloves

- PU palm coated
- Cut level 5
- Sizes 9 & 10 available
- Pack of 12



Code

PU500

12

### Matrix Green - PU Gloves

- Seamless knitted, high cut resistant liner with glass fibre and polyurethane palm coating
- Maximum scores for abrasion, cut, tear and puncture
- Seamless liner and open back for comfort and breath ability, tight fitting for dexterity
- Sizes 9, 10 & 11 available
- Pack of 12



Code

MGP

48

## HAND PROTECTION

### Welders Gauntlets



- Standard size
- Pack of 12



EN388

2016



3243X

Code



SWGG

60

### HexArmor Sharpmaster Gloves



- Very thin & flexible
- Needle resistant
- Visible even in poor and fading light
- Pack of 12



EN388

2003



4533

Code



HEX7082

1

### Tremor-Low Anti-Vibration Gloves



- Reduces the effects of impact, shocks and vibration
- Seamless liner
- Foamed coating
- Conforms to ISO10819:1996
- Sizes: L, XL (9, 10)
- Pack of 12



EN388

2016



3243X

ISO

10819



Code



SAGV

50

### Orange Criss-Cross Gloves



- Sizes: XL (10) only
- Pack of 12



EN388

2016



1131X

Code



SCCG-10

120

**Disposable Latex Gloves**



- Provides maximum dexterity, sensitivity and comfort
- Made from natural latex
- Textured finish for improved grip
- Rolled cuff for additional strength and prevention of liquid roll back
- 100 per dispenser
- Sizes: S, M, L, XL (7, 8, 9, 10)
- Pack of 12

ENQUIRE FOR BULK RATES



Code		
<b>SLDGP</b>	Powdered	10
<b>SLDGP</b>	Powder free	10

**Disposable Blue Nitrile Gloves**



- Offers protection against contamination, dirt and potential irritants in low risk situations
- Textured fingertips for improved grip
- Rolled cuff for additional strength and prevention of liquid roll back
- 100 per dispenser
- Sizes: S, M, XL (7, 8, 10)
- Pack of 12

ENQUIRE FOR BULK RATES



Code		
<b>SGNDP</b>	Powdered	10
<b>SGNDUP</b>	Powder free	10

**Disposable Clear Vinyl Gloves**



- Offers protection against contamination, dirt and potential irritants in low risk situations
- No latex proteins - eliminates protein sensitisation
- Rolled cuff for additional strength and prevention of liquid roll back
- 100 per dispenser
- Sizes: S, L, XL (7, 9, 10)
- Pack of 12

ENQUIRE FOR BULK RATES



Code		
<b>SGVDG</b>	Powdered	10
<b>SGVDUP</b>	Powder free	10

**Stockinette Gloves**



- Soft poly cotton knit wrist
- Die cut to ensure consistency of size
- Pack of 12



Code		
<b>SSTG</b>		10

## HAND PROTECTION

### Classic Lightweight Gloves

- Double PU palm
- General handling tasks
- Sizes: S, M, L, XL, XXL (7, 8, 9, 10, 11)
- Pack of 12



EN388  
2016



4131A



Code

TG1010



120

### Centric Rubber Coated Gloves

- Extra durable latex
- Rugged grip
- Sizes: M, L, XL, XXL (8, 9, 10, 11)
- Pack of 12



EN388  
2016



3131X



Code

TG1050



120

### Hydric Water Resistant Gloves

- Breathable
- Added water resistance
- Sizes: M, L, XL, XXL (8, 9, 10, 11)
- Pack of 12



EN388  
2016



4141A



Code

TG1060



120

### Agile™ 3 Digit Gloves

- General handling
- PU palm coating
- Sizes: M, L, XL, XXL (8, 9, 10, 11)
- Pack of 12



EN388  
2016



3X21A

Code

TG1020



120

### Motion Gloves

- Nitrile palm
- Flexible
- Sizes: M, L, XL, XXL (8, 9, 10, 11)
- Pack of 12



EN388  
2016



4131X

Code

TG1170



120

### 3 Digit Polyurethane Gloves

- For dry conditions
- 3 exposed fingertips
- Sizes: M, L, XL, XXL (8, 9, 10, 11)
- Pack of 12



EN388  
2016



3X43B



Code



TG3220

120

### 3 Digit Polyurethane Gloves

- Double PU palm
- General handling tasks
- Sizes: M, L, XL, XXL (8, 9, 10, 11)
- Pack of 12



EN388  
2003



4X43C



Code



TG5220

120

### Thermic Winter Gloves

- Excellent grip
- Wet and dry conditions
- Sizes: M, L, XL, XXL (8, 9, 10, 11)
- Pack of 12



EN388  
2003



3543



Code



TG5070

120

### Morphic Gloves

- Excellent grip
- Reinforced thumb croch
- Sizes: M, L, XL, XXL (8, 9, 10, 11)
- Pack of 12



EN388  
2016



4X44C



Code



TG5140

120

### Classic Lightweight PU Gloves

- General dry handling tasks
- Sizes: M, L, XL, XXL (8, 9, 10, 11)
- Pack of 12



EN388  
2016



4X43D



Code



TG5010

120

# SONIS™ EAR DEFENDERS PEAK AT AN UNBEATEN 37 SNR



The Sonis™ range has been stylishly designed with a traffic light colour code for easy identification. Materials have been chosen for both performance and comfort for extended periods of use.

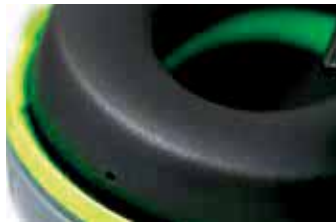

## ✓ PERFORMANCE

The Sonis™ range of ear defenders have been designed by the JSP R&D team. Working with a leading UK acoustic engineering research facility they have developed an ear defender range that peaks at an unbeaten 37 SNR.

## ✓ COMFORT

The over-moulded headband has a built in comfort area with ventilation. The headband force and the cushion surface area work together to provide optimum cushion pressure and comfort.

## ✓ CUSTOMISATION

Sonis™ cups can be coloured to meet a corporate identity. They can also be printed with a company logo for improved brand recognition and to discourage theft. MOQ's apply.



## ✓ ADJUSTABLE STEEL ARMS

To facilitate even distribution of pressure the wearer can tilt and adjust the position of the earcup for optimum comfort and fit.



## ✓ HYGIENIC

The headband is manufactured from TPE, making it easy to wipe clean. The sealing rings are easy to replace. Hygiene kits are available for each model.



## ✓ EXTRA VISIBILITY

The Sonis™ range is available with extra visibility cups and a reflective head band for added low light protection.

HEARING PROTECTION

**Sonis 1 Low Performance Ear Defenders**

- Moderate industrial noise
- SNR=27



AEB010-0CY

Code		
<b>AEB010-0AY</b>	Head	10
<b>AEB010-0CY</b>	Helmet mounted	10

**Sonis 2 Medium Performance Ear Defenders**

- Substantial industrial noise
- SNR=31



Code		
<b>AEB020-0AY</b>	Head	10

**Sonis 3 High Performance Ear Defenders**

- Extreme industrial noise
- SNR=37



AEB040-0CY

Code		
<b>AEB040-0AY</b>	Head	10
<b>AEB040-0CY</b>	Helmet mounted	10

**Sonis Compact Medium Performance Ear Defenders**

- Substantial industrial noise
- SNR=32



AEB030-0CY

Code		
<b>AEB030-0AY</b>	Head	10
<b>AEB030-0CY</b>	Helmet mounted	10

HEARING PROTECTION

**Optime 1  
Ear Defenders**

- EN352-1
- Lightweight
- SNR=27



Code



PEM01

20

**Optime 2  
Ear Defenders**

- EN352-1
- Flexible
- SNR=31



Code



PEM02

20

**Optime 3  
Ear Defenders**

- EN352-1
- Soft cushion
- Comfortable
- SNR=35



Code



PEM03

20

**Optime 2 Neckband  
Ear Defenders**

- Adjustable protection for more demanding noise levels
- Neckband version for use with other protective equipment such as helmets
- Foldable
- Cushion faces protected when folded
- SNR=31



Code



NBOPT2

20



### Helmet Mounted Ear Defenders

- High Quality Rubber cushioning for better protection and comfort
- Adjustable arms
- Conforms to EN 352-3
- CE Marked
- Compatible with most types of Safety Helmet
- 24db protection rating



Code



EPG04

20

### Standard Ear Defenders

**BEST  
SELLER**

- EN352-1
- Lightweight and robust
- Durable high impact polystyrene
- Cost effective protection
- SNR=25



Code



EEG01

20

### Centurion Aegean Helmet Mounted Ear Defenders

- Excellent protection throughout the frequency range
- Attaches to most helmets



Code



S42C

10

### Surefit Contour Clip On Ear Defenders

- Available for MK7, EVO 2, EVO 3 and EVO Lite
- SNR=26



Code



EPG03

20

HEARING PROTECTION

Disposable Foam Ear Plugs

- EN352-1
- Box quantity: 200
- Lightweight and comfortable fit
- SNR=27



Code

EEP01



10

Ear plug Dispenser c/w Ear plugs

- EN352-2
- Wall mountable (fixings included)
- 500 pairs per dispenser bottle
- 50 pairs per refill pack
- SNR=37



Code

EEPDISP Dispenser

EEPDISRF Refill pack



1

1

## Corded Ear Plugs

- EN352-2
- Box quantity: 200
- SNR=37



Code

EEO2



10

## Classic Ear Plugs

- Reusable slow recovery foam
- 1 pair per pillow pack
- Box quantity: 250
- SNR=28



Code

PP01002



1

## Reuseable Ear Plugs

- EN352-2
- Reusable, durable foam plug
- TPE
- Box quantity: 50
- SNR=30



Code

EEO3



1

## Express Push In Ear Plugs

- No roll down required
- Improves hygiene
- Uncorded
- Box quantity: 100
- Certified to EN352-2:2002
- Attenuation SNR=38dB, H=37dB, M=36dB, L=34dB



Code

EEO1021



4

EYE PROTECTION

# PERSONAL EYE PROTECTION STANDARDS & OPTIONS

Standard	Symbol	Explanation
EN166	1	OPTICAL CLASS
EN166	F	LOW ENERGY IMPACT
EN166	B	MEDIUM ENERGY IMPACT
EN166	T	HIGH SPEED PARTICLES AT EXTREME TEMPERATURES
EN166	3	PROTECTION AGAINST LIQUID DROPLETS & SPLASHES
EN170	2-1, 2	PROTECTION AGAINST UV, UVC & UVB
EN172	5-3, 1	SUN GLARE FILTERS, RECOGNITION OF SIGNAL LIGHTS
	K	ANTI-SCRATCH
	N	ANTI-FOG

## Bollé Prescription Safety Glasses

- Take the pack to your local optician (includes everything you need)
- Choose your frame from 16 styles
- Your optician will order them and tell you when they are ready



Code

RXPACK



10



Copyrights: Bolle Safety - F. Bourcier

★ EXCELLENCE **PRESCRIPTION PROGRAM**

- Improves the visibility and safety of employees, craftsmen and professionals
- Cover 98% of the correction needs of your professional clientele with a wide offer accessible to all.
- Quality lenses and a concentrate of innovations for enhanced safety.

To find out more about the procedure, contact us at : [rxsafety@bolle-safety.com](mailto:rxsafety@bolle-safety.com)



Place your orders directly  
in the webshop!

⚡ FAST ⚡ SIMPLE  
⚡ RELIABLE

[bolle-safety.com](http://bolle-safety.com)

**bolle**  
SAFETY

INNOVATION  
2019

# WATCH OUT! EYES SPEAK VOLUMES



empire® conseil - les verres de l'ÉCO-CIPIER

## SILEX, THE NEW MODEL WITHOUT COMPROMISE

Bollé Safety continues to innovate, again and again, offering you solutions adapted to your needs while preserving the optimal quality of its products.

- **No compromise on comfort:** FLEX 160° technology that fits every face perfectly, flexible bi-material temples and absolute support without any pressure points.
- **No compromise on performance:** anti-scratch / anti-fog coating, panoramic vision and ultra-wraparound protection.
- **No compromise on style:** lenses with a refined design and coloured temples by Bollé Safety.
- **No compromise on affordability:** SILEX is suitable for everyone with an excellent price/quality ratio.



### SILEX

Available in clear and smoke versions.

### Bollé Bandido

- EN166 1F AS
- Close fitting wraparound 2 piece safety glasses
- Lightweight
- Anti-fog & anti-scratch
- Supplied with neck cord



Clear

Tinted

Code

<b>EYBB</b>	Clear	10
<b>EYBBT</b>	Tinted	10

### Bollé Rush

- EN166 170 172 1F CE
- Anti-scratch & anti-fog
- Supplied with neck cord



Smoke

Twilight

Clear

Code

<b>EYBRC</b>	Clear	10
<b>EYBRS</b>	Smoke	10
<b>EYBRT</b>	Twilight	10

### Bollé Rush +

- EN166 170 172 1F CE K N
- Revolutionary coating for clarity & light transmission
- Lightweight, maximum comfort & modern design
- Perfect optical quality
- Anti-scratch & anti-fog
- Non-slip bridge & temples



Twilight

SBR Foam & Strap Kit

Clear

Code

<b>EYBRPC</b>	Clear	10
<b>EYBRPS</b>	Smoke	10
<b>EYBRPT</b>	Twilight	10
<b>EYBRPK</b>	SBR Foam & Strap Kit	10

EYE PROTECTION

**Bollé  
Contour**

- EN166 1F AS K N
- Close fitting wraparound 2 piece safety glasses
- Lightweight sports style
- Anti-fog & anti-scratch



Code		📦
<b>EYBC</b>	Clear	10
<b>EYBCT</b>	Tinted	10

**Bollé  
Tracker**

- EN166 170 172 1F CE K N
- Anti-scratch & anti-fog
- Supplied with neck cord



Code		📦
<b>EYTRA</b>	Clear	10
<b>EYTRAT</b>	Tinted	10

**Bollé  
Silex**

- EN166 1FT AS CE K N.
- Ultra-wraparound frame.
- FLEX 160° temples for greater comfort.



Code		📦
<b>EYBSLX</b>	Clear	10
<b>EYBSLXT</b>	Tinted	10



## Wraparound Specs

- EN166 1F AS
- Close fitting wraparound 2 piece safety glasses
- Designed for comfort



Code

**EYWV** Clear

10

**EYWVT** Tinted

10

## Wraparound Sports Style Specs

- EN166 1 F
- Flexible nose piece
- Adjustable
- Comfortable & smart



Code

**EYWZ**

10

## MAX Unbreakable Safety Specs

- EN166 1F
- Robust, flexible design
- Close fitting wraparound



Code

**EYMAXWV**

10

## EYE PROTECTION

### Continental Specs

- EN166
- Wraparound frame
- Lateral protection
- Adjustable non-slip nose
- Non-slip endtips
- Anti-scratch & anti-fog



Code



<b>CONT23C</b>	Clear	10
<b>CONT23S</b>	Smoke	10
<b>CONT23BB</b>	Blue blocker	10

### Expert Specs

- EN166
- Adjustable & non-slip nose pads
- Soft & non-slip endtips
- Flex temples
- Anti-scratch & anti-fog



Code



<b>EXP23C</b>	Clear	10
<b>EXP23S</b>	Smoke	10

### Uvex Pheos

- EN166 1F KNCE
- Supravision HC/AF Lens
- Anti-fog & anti-scratch
- Strong metal-free hinges



Code



<b>EYUVC</b>	Clear	5
<b>EYUVT</b>	Tinted	5
<b>EYUVA</b>	Amber	5

### Visitors Over Specs

- EN166 1 F
- Clear wrapped overspectacles



Code  **EYSJ** 12

### Classic Safety Eye Screen

- EN166 1F
- Panoramic polycarbonate lens
- Moulded side shields, nose bridge & browguard
- Adjustable arms



Code  **EYSS** Black frame: Clear/Amber 12

### Thermex™ Safety Goggles

- TMC™ Technology for fog free use
- UV, dust, liquid splash, molten metal & extreme temperature protection
- Comfortable and secure fitting
- Can be worn with safety helmet or bumpcap
- Anti-scratch & anti-mist



Single lens

Double lens

Code  **AMG623** Single lens 1  
**AMG020** Double lens 1

### UVEX Ultrasonic

- BS EN 345 1B 349
- Panorama field of vision
- Elasticated headband
- Excellent comfort & design with great ventilation system
- Suitable for use with prescription glasses
- Anti-scratch & anti-fog



Code  **EYUGUV** 4

### Direct Vent Safety Goggles

- EN166 1B AS AF
- Lens: clear polycarbonate
- Frame: PVC
- Medium impact

ENQUIRE FOR BULK RATES



Code  **EYGEP** 20

### Professional Indirect Vent Goggles

- EN166 1F AS
- Lens: clear polycarbonate
- Frame: PVC
- Vented frame
- Anti-mist lens coating



Code  **EYGU** 100

EYE AND FACE PROTECTION

**Bollé Atom Goggles**

- EN166 B K N
- Anti-scratch & anti-fog
- Clip-on face shield attachment available.



Code

EYBAG



5

**Bollé Atom Goggles Faceshield Polycarbonate Visor**

- EN166 B
- Anti-scratch & anti-fog
- Used in conjunction with Atom goggle (not included).



Code

EYBAFS



1

**Atlantic Safety Goggles**

- EN166 1 B 3 4 9
- Deluxe anti-mist wide angle goggle
- Wide elastic headband for improved comfort
- Moulded-in ventilation for dust, liquid, molten metal and hot solid protection



Code

AGP020



10

**Safety Specs Neck Cord**

- Breaks free in an emergency
- Black
- Glasses not included



Code

SPCORD



100

**Shape Visor and Cradle**

- EN166
- Perfect optical quality
- Wide field of vision
- Adjustable headband
- Compatible with prescription glasses



Visor

Cradle & Visor

Code

SHA20C

Cradle



1

SHAPEVISOR

Visor

1

**Safety Visor and Carrier for JSP Helmet**

- EN166 1 B 3 9
- To suit Mk1, Mk2, Mk3, EVO2, EVO3 & EVOLite
- Offers protection against medium energy, high speed particles at 120m/s (270mph), liquid droplets & molten metal
- Spare visors available separately



Code

HHVISOR01 Safety Visor & carrier



5

ANX060

Surefit 20cm spare visor

10

### JSP Complete Lens Cleaning Station

- Wall mounted plastic station
- Includes 4 boxes of 280 tissues & one bottle of cleaning spray
- All items easily replaceable
- Includes mirror
- Comes with 4 x screw/plug mounting pack

NEW



Code

EYCLCS



12

### JSP Lens Spray

- Spray cleaning fluid
- Anti bacterial
- 300ml



Code

EYCLSP

PRICE EACH

10+	5 - 9	1 - 4	
8.36	8.92	9.55	12

### Lens Cleaning Station

- For use on plastic, glass & polycarbonate lenses
- 8oz anti-fog & anti-static solution
- 600 tissues per box



### JSP Lens Tissues

- Low lint tissues
- Box of 280



Code

EYCLTS



12

Code

EYCLS



10

## RESPIRATORY EQUIPMENT

**IDENTIFY THE HAZARDS** - dust, metal fume, gas, vapour.

**ASSESS THE HAZARDS** - measure the hazard level/other protection - skin & eye.

**SELECT THE RESPIRATOR** - disposable, half mask, full face, powdered airline.

### HAZARDS:

#### 1) DUST:

Formed by the breaking down of solid materials, the smaller the dust particles the greater the hazard presents.

#### 2) MISTS:

Formed by the processes that involve atomisation (such as spraying), mists consist of tiny droplets.

#### 3) FUMES:

Formed by the vapourisation of a solid material by the application of extreme heat. Extremely fine particles are created as the vapour cools and condenses.

#### 4) VAPOURS:

A gaseous state formed by evaporation from substances that are normally either solid or liquid at room temperature. A fume may form as vapour condenses.

#### 5) GASES:

An air-like substance at room temperature that has the ability to diffuse and spread quickly and travel far.

## TAKE CARE AND PROTECT YOUR AIR

Read the information on this page to help you choose the right breathing protection.

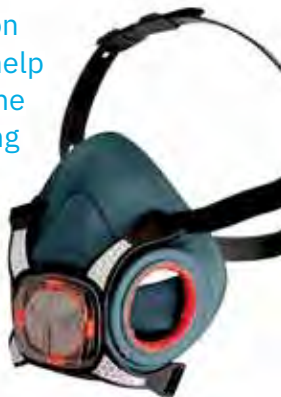

### EUROPEAN STANDARDS

Our respirators are tested to the relevant European Standards. All respirators carry the CE mark plus the European Standard and performance category markings:

**EN149** – Filtering facepiece and particulate respirators

**EN405** – Valved filtering half mask respirators for gases and/or particulates

**EN140** – Half mask facepieces

**EN136** – Full facepieces

**EN137** – Self-contained open-circuit compressed air breathing apparatus

**EN143** – Particulate filters

**EN146** – Powered Respirators – Hoods & Helmets

**EN147** – Powered – Full Face Masks

**EN270** – Heavy Duty Supplied Air

**EN402** – Escape Apparatus. SCBA with full face mask or mouthpiece assembly

**EN529** – Respiratory selection, use and care

**EN1146** – Compressed air escape apparatus with hood

**EN1835** – Light Duty Supplied Air

**EN12941** – Powered Respirators – Hoods and Helmets

**EN12942** – Powered Respirator Full Face Masks

**EN14387** – Gas & vapour filters

Due to current global shortages, prices and availability on these products may be affected. Please contact our sales team to discuss your requirements.

### Disposable FFP1 Moulded Face Mask

- EN149:2001  
+A1:2009



Code

FFP1



20

### Disposable FFP1 Valved Moulded Face Mask

- EN149:2001  
+A1:2009



Code

FFP1V



20

### Disposable FFP2 Moulded Face Mask

- EN149:2001  
+A1:2009



Code

FFP2



20

### Disposable FFP2 Valved Moulded Face Mask

- EN149:2001  
+A1:2011



Code

FFP2V



20

### Disposable FFP3 Valved Moulded Face Mask

- EN149:2001  
+A1:2009
- Fast flow exhalation valve for lighter breathing resistance.
- Double elasticated head straps.
- Adjustable comfort, plus nose seal for optimised fit.

**MAX**  
QUALITY.  
UNMATCHED.



**BEST  
SELLER**

Code

FFP3V



10

ORDER 6AM TO 7PM FOR NEXT MORNING DELIVERY

Set up an account for our discounted rates / prices

# CMT are the **first UK** manufacturer to produce certified **Type II, IIR and 3-Ply** face masks

**No.1 UK  
Manufacturer  
of Certified  
Face Masks**

Our extensive knowledge of personal protective equipment and our commitment to leading innovations in safety, led us to start manufacturing surgical and standard use masks. Producing millions of masks per week with constant expansion to accommodate demand.

Masks are fully certified to EN14638:2019, with official certification and test reports in English - making it clear and simple to process through your own compliance systems.

Production facilities are based at the same complex as our head office, with over 400,000 sq. ft. of manufacturing and warehousing. Get in touch to book a visit, and see the manufacturing process from raw material to finished masks with your own eyes.



**Type II, IIR and 3-Ply face masks are available in a range of pack sizes and packaging options, including own branding**

Our focus is on helping you in guaranteeing a consistent, secure supply of UK manufactured masks at more competitive rates than offshore-sourced products.

**Benefits of ordering through an accredited UK supplier rather than importing:**

- Removes any risk of inconsistent supply
- Save weeks of time on delivery
- Deal with a professional UK team
- Avoid overstocking with reduced MOQs
- Supports UK manufacturing
- Avoid exchange rate fluctuations
- Supports our economy

Call us: **020 8311 1144**  
Email: [enquiries@cmtgroup.co.uk](mailto:enquiries@cmtgroup.co.uk)  
[www.cmtgroup.co.uk](http://www.cmtgroup.co.uk)





# Specification for Type II & IIR

These high-quality products are independently tested and accredited by ISO 17025 accredited laboratories, in line with all elements of the following international standards. Test reports and other documentation are available on request.

<b>Full product name:</b>	Disposable Non-Sterile Medical Face Masks Type IIR 3-Ply
<b>Product size:</b>	180mm x 90mm (ear loops = 180mm)
<b>Product Weight:</b>	2 grams
<b>Product Material:</b>	Inner layer: White spunbonded non-woven polypropylene 25g/sqm
<b>Outer layer:</b>	Blue spunbonded non-woven polypropylene 25g/sqm
<b>Filter media:</b>	Meltblown white non-woven polypropylene 25g/sqm, 0.35mm thickness
<b>Elastic strap:</b>	2mm thick white elastic – latex free
<b>Nose piece:</b>	3mm thick metal wire encased in white plastic, 165mm length
<b>Product Performance:</b>	EN14683:2019 Bacterial Filtration Efficiency (BFE) $\geq$ 99% Differential Pressure $\leq$ 10.2 Pa/cm <sup>2</sup> Synthetic Blood Resistance: PASS (2R only) Microbial Contamination/Bioburden $\leq$ 23 C.F.U./g
<b>Product Colour:</b>	Blue / White
<b>Packaging Size:</b>	70mm x 200mm x 100mm
<b>Packaging Units:</b>	5, 10 or 50 per inner box
<b>Manufacturer:</b>	CMT Equipment LTD – Trident Works, Mulberry Way, Belvedere, London, DA17 6AN
<b>Storage Conditions:</b>	Store in a well-ventilated room where the relative humidity does not exceed 80%. Avoid high temperatures, keep away from fire and flammable materials.
<b>Shelf Life:</b>	5 years in original packaging
<b>Handling:</b>	Keep in original packaging until use – do not reuse. Replace when damp or damaged
<b>Conformities:</b>	EN 14683:2019: CE Marked; Registered with MHRA. Produced in accordance with MDR 2017/745. Class I medical device (non-sterile)
<b>Dermatological Tolerance:</b>	No known intolerance, does not contain latex
<b>Conditions:</b>	Non-sterile



DISPOSABLE RESPIRATORS

**3M FFP3 Valved Face Mask**

- Secure face fit for increased comfort
- Reliable, effective protection against fine particulates
- Comfortable, lightweight design
- Soft inner face-seal ring
- Protection factor 50
- Pack of 10
- Availability dependent on manufacturer supply



Code

**3M8833**



1

**Pro Series Respirator**

- Pack of 10
- 3 panel fold flat design
- Low breathing resistance
- Lightweight
- Available in small sizes
- Sculpted nose fit
- Chin tab
- Availability dependent on manufacturer supply



Code

**3M9332**



12

**Moldex 2555 Mask**

- FFP3
- Pack of 10
- EN149:2001 + A1:2009
- Availability dependent on manufacturer supply



Code

**M2555**



10

**Moldex 2305 Mask**

- FFP3
- Pack of 10
- EN149:2001 + A1:2009
- Availability dependent on manufacturer supply



Code

**MM2505**



10

**Uvex Silv-Air**

- FFP3 breathing protection folding mask
- Exhalation valve
- Labelled for use with high levels of dust exposure (D)
- Adjustable headband length
- Pack of 15
- Availability dependent on manufacturer supply



Code

**UVFFP3V**



10

**Uvex Silv-Air Valved Moulded Disp Mask**

- FFP3 breathing protection preformed mask
- Exhalation valve
- Labelled for use with high levels of dust exposure (D)
- Comfortable, four-point headband attachment
- Pack of 15
- Availability dependent on manufacturer supply



Code

**UVFFP32310**



10

**Flexinet FFP3 Valved Face Mask**

- P3 valved
- High efficiency (99% minimum) filtering with exhale valve
- Fully adjustable 4-point harness
- Availability dependent on manufacturer supply



Code



FFP3V832

5

**Olympus FFP3 Valved Moulded Face Mask**

- EN149:2001 +A1:2009
- Colour coded to show FFP value
- Harness
- Availability dependent on manufacturer supply



Code



FFP3VOLYMPUS

5

**Typhoon Horizontal Fold Flat FFP3 Face Mask**

- EN149:2001 +A1:2009
- Individually wrapped
- Comfort foam
- Unique valve system
- Availability dependent on manufacturer supply



Code



FFP3335

10

**Olympus Fold Flat FFP3 Valved Face Mask**

- EN149:2001 +A1:2009
- Individually wrapped
- Shaped to fit for added comfort
- Colour coded to show FFP value
- Availability dependent on manufacturer supply



Code



P3VOLFF

10

# PPE Recycling

Secure  
Sustainable  
Solutions

CMT has teamed up with one of the UK's leading secure destruction specialists to provide a nationwide service for the secure destruction and recycling of all types of PPE. As well as improving your carbon footprint and protecting the environment, this service can also be used as a secure way to protect your brand. All materials can be collected from your site and taken to a secure facility where it is destroyed by shredding and recycled.



**1** Order your recycling station with one of our sales team using code: **SBRP**



**3** Choose either a 1, 2 or 4 week collection time frame and we will collect the bin and take the items to a secure recycling facility

**2** We deliver your recycling point to your chosen delivery address.

**4** We will provide you with a Certificate of Destruction if required, giving you peace of mind

Footwear



Hearing Protection



Eyewear



Gloves



Helmets



Respiratory Equipment



Workwear



Working in conjunction with our Charity Partners some of the unbranded garments can be sent out to 3rd world countries in support of less fortunate communities

CMT embraces the circular economy concept, whereby we keep resources in use for as long as possible, extract the maximum value from them whilst in use, then recover and regenerate products and materials at the end of each service life.

Contact our team  
**020 8311 1144**

Licensed Waste Carrier No. **CBDL318836**

## FACE FIT TESTING

Qualitative Fit Testing can be used on what are defined as tight fitting respirators, with the exception of full face masks.

Qualitative Fit Testing can be used not only as a test method to ensure your employees are properly protected; but also as a very effective way of training them in the correct way of fitting a mask. Dust and half masks commonly fail to do the job they are intended to do because of poor fitting and care by the user.

CONTACT US FOR MORE DETAILS

**020 8311 1144**

### Qualitative Face Fit Testing Kit

- FACET - Full test kit
- FACESOL - 2x bottles



Code

FACET



1

FACESOL

1

ORDER **6AM TO 7PM** FOR NEXT MORNING DELIVERY

Set up an account for our discounted rates / prices

**315**

JSP FORCE 8 RESPIRATORS

Force8™ PressToCheck™ Half Mask

- One of the lightest, most well balanced half face masks available
- Facepiece padded thermoplastic, moulds to face shape for excellent seal
- CR2 reflective strips increase visibility in low-light environments for added safety
- Filter Force8™ filters available with low profile angle design for minimal visual impairment
- Conforms to EN142
- Daily Face Fit reassurance
- Passes dolomite
- Protection against construction dusts
- Improved hygiene
- Inhalation valve for easy maintenance
- Low profile covers protect filters
- Convenient belt bag available



BHT0A3



BHT003



BPT170

Code			
<b>BHT0A3</b>	Size: Medium	Half mask kit complete, including P3 filters	10
<b>BHT003</b>	Size: Medium	Half mask only (no filters included)	10
<b>BHG003-1L5</b>	Size: Small	Half mask only (no filters included)	10
<b>BHG003-2L5</b>	Size: Large	Half mask only (no filters included)	10
<b>BPT170</b>		Force8™ belt bag	10

P3 Twin Filter

- BMN990-001-700 (F8-003.1)
- Twin filter cartridges for Force8™
- High efficiency dust
- Press to check technology
- Offers an assigned protection factor (APF) of 20 x Workplace Exposure Limit (WEL) against fine dusts, fibres, fumes and liquid aerosols when attached to Force8™



Code  BMN990 10

Compact P3 Twin Filter

- BGC310-001-000
- Twin filter cartridges for Force8™
- High Efficiency Dust
- Press to check technology
- Compact and lightweight.



Code  BGC310 10

P2 Twin Filter

- BMN380-011-700 (F8-002)
- Twin filter cartridges for Force8™
- Medium efficiency dust
- Press to check technology
- Offers an assigned protection factor (APF) of 10 x Workplace Exposure Limit (WEL) against fine dusts, fibres, fumes and liquid aerosols when attached to Force8™



Code  BMN380 10

### PG30 Full Face Visor Respirator

- FogControl™ innovative valves to direct breath downwards
- Full-face non-mist clear sealed visor provides excellent visibility
- Pressure-correcting pivot headband attachment that ensures an even seal
- Soft ComfortPlus Silicon Seal
- Extra Lightweight Manufactured Components
- Dual elastic headband with scull cradle
- CE Certified
- EN140:1998
- Compatible with PGP3 EN143:2000 P3 certified filters



PG30



PGP3

Code

<b>PG30</b>	Face Visor
<b>PGP3</b>	Filters

	10
	10

### MOD28 Half Mask Respirator

- 2 Filter Half Mask that has a soft and flexible body in order to obtain a very good fit to the users face
- Well balanced and weighted and even pressure distribution to the face
- Incorporates a patented bayonet system making removing and exchanging filters very simple and easy
- Suitable for use against vapours, gases and/or particles and dust.
- Complies to EN140:1998
- CE Marked according to EU regulation 89/686/EEC as PPE CAT III



MOD28F

MOD28

Code

<b>MOD28</b>	10
<b>MOD28F</b>	10



### PG28 Half Mask Respirator

- FogControl™ innovative exhale valve to direct breath downwards and not mist goggles or spectacles
- Pressure-correcting pivot headband attachment that ensures an even seal
- Soft ComfortPlus Silicon Seal
- Dual elastic headband with scull cradle
- CE Certified
- EN140:1998
- Compatible with PGP3 EN143:2000 P3 certified filters



PGP3



PG28

Code

<b>PG28</b>	10
<b>PGP3</b>	10



## POWERED AIR RESPIRATOR

### Jetstream Constructor Kit

- Jetstream® Mk® 7 Helmet with Visor, Nylon Hood and Hose – Battery pack and filter unit not included
- HDPE industrial safety helmet for EN397 protection against falling hazards with sealed visor
- Conforms to EN 12941:1999. Polycarbonate Visor conforms to EN 166.1.B.3.9.

CBP020



CBH010

Code



**CBP020**

Kit

1

**CBH010**

Helmet and visor

1

### Jetstream 8 Hour Switch & Go Kit

- White nylon hood and reinforced hose to prevent kinking
- Belt mounted rechargeable respirator with large capacity disposable dust filter
- EN 12941:1999

CBB610



CBH030

Code



**CBB610**

Kit

1

**CBH030**

Alternative headpiece

1

### Jetstream Filters & Spares

- EN 12941:1999



CBU220



CBU620



CBU610

Code



**CBU220**

Jetstream waist mounted power unit Gas / Vapour TH2A2 filter

1

**CBU620**

Gas / Vapour GV-XA2 filter

1

**CBU610**

Jetstream PSL filter

1



## PowerCap Infinity Powered Air

- Nominal protection factor = 500
- Unique powered air respiratory protection system
- User responsive smart PPE
- Conforms to EN 12491:1998 + A2:2008, EN166.B, EN397
- High capacity HEPA filters
- Delivers 160 litres of clean air per minute
- Carry / storage box
- Easy maintenance
- Weight: approx 1.6kg



Code

CEA646



1

ORDER 6AM TO 7PM FOR NEXT MORNING DELIVERY

Set up an account for our discounted rates / prices

319

## HEAD PROTECTION

### EVOLite® Mid & Micro Peak Ventilated Helmet with Slip Ratchet

- Conforms to EN397
- Extremely lightweight and ultra strong helmet
- Ultra comfortable 6-point terylene harness with 3D precision fitting
- Easyjust slip ratchet adjustment, UV stabilised
- Chamlon sweatband for maximum absorption
- Side and rear ventilation



#### Code



<b>HHEVOLS-WHT</b>	White	Mid peak	10
<b>HHEVOLS-YEL</b>	Yellow	Mid peak	10
<b>HHEVOLS-GRN</b>	Green	Mid peak	10
<b>HHEVOLS-BLU</b>	Blue	Mid peak	10
<b>HHEVOLS-RED</b>	Red	Mid peak	10
<b>HHEVOLS-ORG</b>	Orange	Mid peak	10
<b>HHEVOLS-BLK</b>	Black	Mid peak	10
<b>HHEVOLM-WHT</b>	White	Micro Peak	10
<b>HHEVOLM-YEL</b>	Yellow	Micro Peak	10
<b>HHEVOLM-BLU</b>	Blue	Micro Peak	10
<b>HHEVOLM-RED</b>	Red	Micro Peak	10

### EVO®3 Standard (Mid) Peak Ventilated Helmet with Slip Ratchet

- Conforms to EN397
- Extremely tough HDPE shell
- Ultra comfortable 6-point terylene harness, 3D precision fit
- Easyjust slip ratchet adjustment, UV stabilised
- Chamlon sweatband for maximum absorption
- Side & rear ventilation
- Micro peak, non vented & wheel ratchet available to order



#### Code



<b>HHEVO3S-WHT</b>	White		10
<b>HHEVO3S-YEL</b>	Yellow		10
<b>HHEVO3S-GRN</b>	Green		10
<b>HHEVO3S-BLU</b>	Blue		10
<b>HHEVO3S-RED</b>	Red		10
<b>HHEVO3S-ORG</b>	Orange		10
<b>HHEVO3S-BLK</b>	Black		10

### EVO®2 Standard (Mid) Peak Ventilated Helmet with Slip Ratchet

- Conforms to EN397
- Top level protection at an economical price
- 6 point polyethylene harness
- One touch slip ratchet adjustment, UV stabilised
- Side & rear ventilation
- Micro peak & non vented available to order



Code		
<b>HHEVO2-WHT</b>	White	10
<b>HHEVO2-YEL</b>	Yellow	10
<b>HHEVO2-GRN</b>	Green	10
<b>HHEVO2-BLU</b>	Blue	10
<b>HHEVO2-RED</b>	Red	10
<b>HHEVO2-ORG</b>	Orange	10
<b>HHEVO2-BLK</b>	Black	10

### EVO®3 Micro Peak Ventilated Helmet with Slip Ratchet

- Conforms to EN397
- Extremely tough HDPE shell
- Ultra comfortable 6-point terylene harness, 3D precision fit
- Easyjust slip ratchet adjustment, UV stabilised
- Chamlon sweatband for maximum absorption
- Side & rear ventilation
- Mid peak, non vented & wheel ratchet available to order



Code		
<b>HHEVO3M-WHT</b>	White	10
<b>HHEVO3M-YEL</b>	Yellow	10
<b>HHEVO3M-BLU</b>	Blue	10
<b>HHEVO3M-RED</b>	Red	10
<b>HHEVO3M-BLK</b>	Black	10

## HEAD PROTECTION

### EVOLite® Skyworker™ Industrial Working At Height Helmet

- Specifically designed with a suspension system & shell structure that offer maximum head protection, making working at height safer than it has ever been
- Shock-absorbing expanded polystyrene liner for excellent side, front and rear impact protection
- Conforming to EN12492 & the impact test of EN397
- High strength ABS shell
- Micro peak
- Four point 'X-over' chinstrap & adjustable harness system
- Wheel ratchet adjustment system for firm & comfortable fit



Code

Code	Color	Quantity
AJS260-WHT	White	10
AJS260-YEL	Yellow	10
AJS260-GRN	Green	10
AJS260-BLU	Blue	10
AJS260-RED	Red	10
AJS260-ORG	Orange	10
AJS260-BLK	Black	10

### EVO®5 Dualswitch™ Dual Standard Safety Helmet

- JSP's EVO®5 DualSwitch™ is fully certified to both EN397 (ground level) and EN12492 (at height), with the ability to change between the two standards easily at the flick of a switch
- Micro peak
- Four point 'X-over' chinstrap & adjustable harness system
- Wheel ratchet adjustment system for firm & comfortable fit.



Code

Code	Color	Quantity
AKS270-WHT	White	10
AKS270-YEL	Yellow	10
AKS270-BLU	Blue	10
AKS270-ORG	Orange	10
AKS270-BLK	Black	10

**Eco Hard Hat**

- Conforms to EN397
- 6 point harness
- Lightweight
- Slip ratchet adjustment
- Comfort plus sweatband



Code



**HHECON-WHT** White

10

**HHECON-BLU** Blue

10

**Centurion Concept Safety Helmet**

- Extremely light yet strong helmet
- 6-point terylene crade with highly absorbent sweat band
- Side and rear ventilation for comfort
- Extended nape area for extra neck protection
- Reduced peak and wheel ratchet adjustment available to order



Code



**S09WF**

10

**Centurion Reflex Safety Helmet**

- 6 point Nylon Textile webbing
- Brushed nylon sweatband
- Ventilated
- Supplied with a Silver rear Flash as standard. Also available with a High visibility Yellow or Orange rear Flash or as a complete High Visibility helmet
- White or orange helmets available



Code



**S12WMVOA**

10

## HEAD PROTECTION

### EVOSpec - Helmet Mounted Eyeshield

- Retracts neatly and securely into helmet when not in use
- Stylish design
- 6 base curve lens offers optimum coverage for all users
- Low profile Bi-Polymer nose clip for improved comfort and security
- To suit EVO2, EVO3 and Evolite hard hats



Code

**ANT010** Clear



10

**ANT120** Smoke

10

### Centurion Face Carrier and Screen

- Fits S09WF



Code

**S54CE** Carrier



10

**S590C** Screen

10

### Safety Visor and Carrier for JSP Helmet

- EN166 1 B 3 9
- To suit Mk1, Mk2, Mk3, EVO2, EVO3, EVOLite
- Offers protection against medium energy high-speed particles at 120m/s (270mph), liquid droplets and molten metal



Code

**HHVISOR01**



10

## EVO® VISTAlens™

- EVO® safety helmet incorporating a fully retractable optical class 1 integrated overspec.
- Easy to deploy, adjust and maintain ensuring protection is on hand whenever required.
- Fully adjustable wheel ratchet and unique 3D adjustment system.
- Anti-scratch and anti-mist resistance.
- Conforms to EN166.1.FT impact protection.
- Clear or smoke overspec options available



**NEW**

### Code

Code		
HHVSTLC-WHT	White - clear lens	10
HHVSTLC-BLU	Blue - clear lens	10
HHVSTLS-WHT	White - smoke lens	10
HHVSTLS-BLU	White - smoke lens	10

## EVO® VISTAshield™

- EVO® safety helmet incorporating a fully retractable optical class 1 integrated faceshield offering A-rated impact protection.
- Easy to deploy, adjust and maintain ensuring protection is on hand whenever required.
- Anti-scratch and anti-mist resistance.
- Fully adjustable wheel ratchet and unique 3D adjustment system.
- Conforms to EN166.1.AT impact protection.
- Clear or smoke overspec options available



**NEW**

### Code

Code		
HHVSTSC-WHT	White - clear shield	10
HHVSTSC-BLU	Blue - clear shield	10
HHVSTSS-WHT	White - smoke shield	10
HHVSTSS-BLU	White - smoke shield	10

## HELMET ACCESSORIES

### Reflective Helmet Sticker Kits

- Helmet not included
- Packs of 10

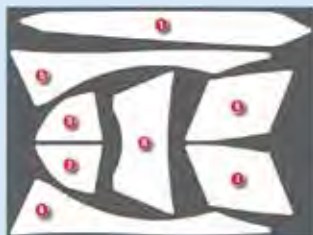

AHV390



AHV391



Code



**AHV391** For EVO2 and EVO3

1

**AHV390** For EVOLite

1

### VISILite Helmet Light

- Increases worker visibility without dazzling
- Offers 3 light modes
- Fits all EVO safety helmets
- Up to 50m visibility
- USB rechargeable



AHV855



AHV860

Code



**AHV860** EVOLite

10

**AHV855** EVO2 and EVO3

10

### Quick Release 4 Point Linesman Harness

- Fits EVO2, EVO3 and EVOLite
- Ideal for working at heights
- With 4-point chin strap harness
- Conforms to EN397, ENS0365 and ANSIZ89
- Helmet not included



Code



**AHV200**

10

### Helmet Chin Straps



CS10

CS10D

Code



**CS10** Chin strap

10

**CS10D** Chin strap deluxe

10

### Chamlon Helmet Sweatband

- Fits EVO2, EVO3 and EVOLite
- Egyptian cotton core
- Porous PU coating for sweat absorption
- PH neutral
- Dermatologically tested



Code



**AJA840**

10

### In Case Of Emergency (Ice) Info Holders

- Gives instant access to potentially life saving information
- Helmet not included



Code



**ID10**

100



### Winter Helmet Liners

- Suitable for all helmets
- Velcro straps for a secure fit
- Can be worn with a chin strap
- Polycotton
- One size
- Hi vis versions conform to EN471
- Helmet not included



HHLIN



HHLINHV

Code



**HHLINHV** Hi vis yellow

10

**HHLIN** Black

50

### Railway Helmet Warmer

- Hi visibility orange full head and face comforter
- Conforms to EN471 GO/RT 3279
- Helmet not included



Code



**AHV380**

10

### Helmet Comforter

- Egyptian cotton core
- Porous PU coating for sweat absorption
- PH neutral
- Dermatologically tested



Code



**AHV000**

10

### Surefit Thermal Helmet Liner

- Contact us for details on how to get your logo embroidered onto this product
- Helmet not included



Code



**SFITBN**

144



**BRANDit**

## FALL ARREST & RESTRAINT

### 2m Single Tail Scaffolder's Lanyard

- Complete with 1 steel karabiner and 1 steel scaffold hook
- Lanyard conforms to EN355:2002
- Connectors conform to EN362:2004 Class B/T



Code

**FAR0305**



5

### K2™ Single Tail

- Complete with 1 captive pin aluminium screw gate karabiner and 1 aluminium scaffold hook
- Lanyard conforms to EN355:2002
- Connectors conform to EN362:2004 Class B/T



Code

**FAR0404**



5

### Pioneer™ Scaffolder's 2m FAL

- Complete with 1 captive pin aluminium screw gate karabiner and 1 aluminium scaffold hook
- Lanyard conforms to EN355:2002
- Connectors conform to EN362:2004 Class B/T

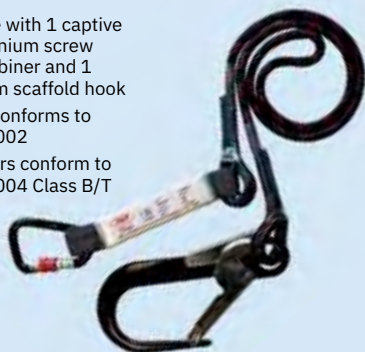

Code

**FAR0206**



5

### Spartan™ Work Positioning Lanyard

- 2m adjustable restraint lanyard made from 14mm polyamide 3-strand twisted rope
- Manual ring type adjuster made of forged alloy steel
- Cost effective
- Conforms to EN358:1999



Code

**FAR0308**



10

### 2m Lightweight Retractable Fall Limiter

- Weighing less than 600g this fall limiter is the lightest in its class in the world
- Fall indicator
- External shock absorber
- Conforms to EN360:2002



Code

**FAR0701**



5

### 5m Wire Retractable Fall Limiter

- Atex approved
- Complete with 1 steel karabiner and 1 steel scaffold hook
- Lanyard conforms to EN355:2002
- Connectors conform to EN362:2004 Class B/T



Code

**FAR0705**



5

FALL ARREST AND RESTRAINT

**Pro-Fit™ 1-Point Harness**

- Comfort is important to users as this leads to good practice when donning the product
- Fully elasticated
- Lightweight and ultra comfortable
- Conforms to EN361:2002



Code



**FAR0101**

5

**Pioneer™ 2-Point Harness**

- Two attachment points
- Fully adjustable chest, shoulder and leg straps to a weight of 136kg
- Ideal for fall arrest and restraint
- Conforms to EN361:2002



Code



**FAR0203**

5

**Spartan™ 1-Point Harness**

- A stylish product that does not falter when safety is paramount
- Cost effective
- Conforms to EN361:2002



Code



**FAR0301**

10

**JSP Confined Space Tripod**

- Suitable for use on un-even surfaces
- A pulley system provided for steel cable guiding in case a winch is used
- Securely connected two eyebolts to be used for connection to PPE
- Adjustment achieved by sliding telescopic legs
- Load capacity 500kg
- Height: 1.35 to 2.15m
- Footprint: 0.80 to 1.50m
- Weight: 13kg
- Conforms to EN795 class B



Code



**FAR1003**

1

FALL ARREST AND RESTRAINT

**Pioneer™ Fall Arrest Kit**

- 2-point harness
- 2m fall arrest lanyard
- JSP rucksack
- Harness conforms to EN361:2002
- Fall arrest lanyard conforms to EN355:2002



Code



**FAR1104**

5

**Spartan™ Restraint Kit**

- 1-point Spartan harness
- 1.8m fixed length lanyard
- JSP woven drawstring bag
- Harness conforms to EN361:2002
- Restraint lanyard conforms to EN354:2010



Code



**FAR1101**

5

**Pioneer™ Construction Kit**

- 2-point Pioneer harness
- 2m lightweight retractable fall limiter
- JSP rucksack
- Harness conforms to EN361:2002
- Retractable fall limiter conforms to EN360:2002



Code



**FAR1110**

3

# HI VIS CLOTHING & WORKWEAR



Work Bags	334
Hi Vis Clothing	335-345
Weather Proof Clothing	346-349
Ladies Clothing	350-351
PPE Recycling	352
Rail Vests	353
Rail Clothing	354-358
Rail Accessories	359-360
Workwear	361-368
Knee Protection	369
Flame Retardant Clothing	370-377
Arc & Flame Retardant Clothing	378-382

**BRAND** 

KEY TO SYMBOLS

CLOTHING SIZE COMPARISON:

MEN'S CHEST SIZES		MEN'S WAIST SIZES	
SIZES	INCHES	SIZES	INCHES
SMALL	36 - 38"	SMALL	30 - 32"
MEDIUM	40 - 41"	MEDIUM	33 - 34"
LARGE	42 - 44"	LARGE	36 - 38"
X LARGE	46 - 48"	X LARGE	40 - 41"
2X LARGE	50 - 52"	2X LARGE	42 - 44"
3X LARGE	54 - 55"	3X LARGE	46 - 47"
4X LARGE	56 - 58"	4X LARGE	48 - 50"



Waterproof



Anti-static



Breathable



Water repellent



Flame retardant



Arc flash protected



**3 EN ISO 20471**  
High visibility clothing



**3/1 EN 343**  
Breathable, wind and waterproof clothing



**3/2 EN 342**  
Certified Protection against cold



**EN ISO 11611**  
Protection against infective agents



**EN ISO 11612 & 14116**  
Protection against heat and flame



**EN 1073-2**  
Protection against radioactive contaminants



**EN 61482-1-2**  
Protection against electric arc flashes



**EN 13034**  
Protective clothing against liquid chemicals



**EN 1149-3 / EN 1149-5**  
Protective clothing with electrostatic properties



**EN ISO 13982**  
Protection against solid particulates



**UV Standard 801**  
Protection from UV rays



**RIS 3279**  
High visibility for rail workers



**EN510 Anti Entanglement**  
Protective clothing that minimises the risk of entanglement



# GARMENT PRINTING & EMBROIDERY

We offer a range of in-house garment decoration options

We'll work with you to print your garments exactly how you need them and we're dedicated to providing you with a reliable, cost effective and fast service

## HEAT TRANSFER

Printed designs are often best suited for larger and more intricate designs, and tend to behave better when applied to lighter weight materials, such as reflective vests and jackets. The downside is that they tend to have a shorter lifespan than embroidered alternatives.



## EMBROIDERY

Embroidery gives a high quality and long lasting result that is perfect for staple workwear items such as polo-shirts and fleece jackets. Ideal for most standard company logos, embroidery is more durable and can survive multiple washes, often retaining its quality for the lifetime of the garment.



**CALL 020 8311 1144**

WORK BAGS

Hi Vis Rucksacks



- 250gsm
- 600D Polyester
- 25 litre capacity
- Multiple pockets
- Padded back panel for comfort
- L 28cm, W 21cm, H 43cm



HVRKO



HVRKY

Code

- HVRKY** Yellow
- HVRKO** Orange

Holdall Bags



- 520gsm
- Nylon PVC coated
- Ideal for tools or clothing
- ID holder
- Two zipped compartments
- Adjustable shoulder strap
- Call for details & prices on having your logo printed



Code

- B900KITBAG** L680 x W250 x H390mm
- B903KITBAG** L480 x W230 x H320mm

Jumbo Kitbag



- Polyester fabric
- L750 x W350 x H300mm
- Ideal for tools or clothing
- Zipped end pockets
- Padded hand grip
- Call for details & prices on having your logo printed



Code

**KITBAG**



OPERATIVE MAN-PACK KIT BAGS



**CONTACT US TODAY**  
**020 8311 1144**



**Hi Vis Superior Waistcoats**

- 100% polyester
- Deeper arm holes
- Scooped sides allowing pocket access
- ID pocket
- Mobile phone pocket
- 2 front bellowed storage pockets
- Double pen pocket with D-Ring

BRAND **it**

**NEW**



**Code**

- W11-Y/N** Yellow / Navy
- W11-O/N** Orange / Navy
- W11-Y/O** Yellow / Orange
- W11-R/GY** Red / Grey

ORDER **6AM TO 7PM** FOR NEXT MORNING DELIVERY

Set up an account for our discounted rates / prices

HI VIS CLOTHING

Hi Vis Vests

- 100% polyester
- Hook & loop fastener
- Pink vest non EN471
- Other colours available to order
- S-4XL



Code

- HVWY** Yellow
- HVWO** Orange
- HVWR** Red
- HVWP** Pink

Hi Vis Executive Vest

- 100% polyester
- Mobile phone pocket
- ID pocket
- 2 front pockets
- Double pen pocket
- Heavy duty zip
- Contrast colours available
- S-4XL



Code

- HVWY1151** Yellow
- HVWO1161** Orange

Hi Vis Long Sleeved Executive Vest

- Scooped sides allowing pocket access
- Mobile phone pocket
- ID pocket
- 2 front bellowed storage pockets
- Double pen pocket with D ring
- S-4XL



Code

- HVWY1251** Yellow
- HVWY1261** Orange

**Long Sleeved Hi Vis Vest with Orange Brace** BRAND 

- Zip fastener
- Ventilated mesh shoulders, sides & under arms
- ID pocket & mic loop
- Phone pocket
- Pen holder
- S-4XL



Code

**1286CV**

**¾ Sleeved Hi Vis Vest with Orange Brace** BRAND 

- Zip fastener
- Ventilated mesh shoulders, sides & under arms
- ID pocket & mic loop
- Phone pocket
- Pen holder
- S-4XL



Code

**HVSW1246CV**

**Classic T-Shirt** BRAND 

- 150gsm
- 100% polyester birds eye knit
- Lightweight, breathable & extremely comfortable
- S-4XL



HVTSO

HVTSY



Code

**HVTSY** Yellow

**HVTSO** Orange

**Hi Vis Long Sleeved Vest** BRAND 

- S-4XL



HVSWY

HVSWO



Code

**HVSWY** Yellow

**HVSWO** Orange

50% less emissions  
  
50% less carbon dioxide

## PROTECTION THAT DOESN'T COST THE EARTH



### 100% recycled polyester



Recycled clothing is chopped into pieces.



Pieces are processed into raw polyester material.



Polymerisation produces ECO CIRCLE™ fibres from Jiaren, Japan.

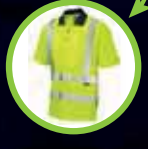

We take these fibres to create EcoViz® rp – a polyester fabric that fully conforms to ISO 20471.

### 100% recycled polyester



**Ecoviz Polo Shirt**



- Generous Fit
- 100% Ecovis Recycled Polyester
- Split-Hem Design
- Strategically Positioned Reflective Tape for Optimal Wearer Movement
- UV Protection to UPF 40+ meeting EN 13758-2
- S-4XL



HVPSEY

HVPSEO



Code

**HVPSEY** Yellow

**HVPSEO** Orange

**Ecoviz Sleeved Polo Shirt**



- Generous Fit
- 100% Ecovis Recycled Polyester
- Split-Hem Design
- Strategically Positioned Reflective Tape for Optimal Wearer Movement
- UV Protection to UPF 40+ meeting EN 13758-2
- S-4XL



HVSPSEY

HVSPSEO

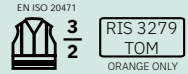

Code

**HVSPSEY** Yellow

**HVSPSEO** Orange

**WE OFFER WORKWEAR AND PPE RECYCLING**



FOR MORE INFO SEE PAGE 352



HI VIS CLOTHING

Short Sleeved Polo Shirt



- 175gsm
- 100% polyester birds eye knit
- Solar protection factor (SPF) rating 50+
- Wicking treatment for added comfort
- S-4XL



HVPSO

HVPSY

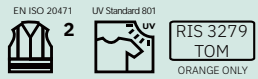

Code

- HVPSY** Yellow
- HVPSO** Orange

Long Sleeved Polo Shirt



- 175gsm
- Polycotton double knitted: 75% polyester 25% cotton
- Wicking polyester fibres channel moisture away from the body
- S-4XL



HVLPSO

HVLPSY



Code

- HVLPSY** Yellow
- HVLPSO** Orange

Classic Sweatshirt



- 300gsm
- Polycotton: 65% polyester 35% cotton
- Ideal when it's too cold for a T-Shirt but too warm for a jacket
- Hard-wearing, functional & comfortable
- Elasticated waistband & cuffs
- S-3XL



HVSSO

HVSSY



Code

- HVSSY** Yellow
- HVSSO** Orange

Classic Hoodie



- 300gsm
- Polycotton: 65% polyester 35% cotton
- S-3XL



B304O

B304Y



Code

- B304Y** Yellow
- B304O** Orange

Lined Fleece



- 380gsm
- Anti-pil polyester
- Full length front zip
- Front pockets
- Elasticated cuffs and hem
- S-4XL



HV2066



HV2061



Code

- HV2061** Yellow  
**HV2066** Orange

Body Warmer



- 300D PU coated polyester
- Fleece lined collar
- Quilted lining
- Interactive YKK zip fastener
- Mobile phone pocket
- Multiple pockets
- Cord hem & cuff adjuster
- S-3XL



HVBWO



HVBWY



Code

- HVBWY** Yellow  
**HVBWO** Orange

Soft Shell Jacket



- 100% stretch polyester with internal micro fleece
- Fleece lined collar
- Interactive YKK zip fastener
- Mobile phone pocket
- Semi concealed zipped chest pocket & zipped front hand pockets
- Shock cord hem & cuff adjuster
- Retromax reflective tape
- S-3XL



HV2110



HV2100



Code

- HV2100** Yellow  
**HV2110** Orange

## HI VIS CLOTHING

### MAX Polycotton Cargo Trousers



- 280gsm
- Poly/cotton: 80% polyester 20% cotton
- Water & stain repellent fabric
- Triple stitched main seams with reflective piping
- Internal knee pad pockets
- Back pocket with reflective piping



<b>Short</b>	30-40	
<b>Reg</b>	28-46	30-44
<b>Tall</b>	28-48	30-44



HVYPT

HVOPT



EN ISO 20471



Code

**HVYPT** Yellow

**HVOPT** Orange

### Polycotton Cargo Trousers



- 280gsm
- Poly/cotton: 80% polyester 20% cotton
- Water & stain repellent fabric
- Triple stitched main seams with reflective piping
- Internal knee pad pockets
- Back pocket with reflective piping



<b>Reg</b>	30-40	28-54
<b>Tall</b>	28-48	28-54



HVYNVPT

HVONVPT



EN ISO 20471



Code

**HVYNVPT** Yellow / Navy

**HVONVPT** Orange / Navy

### Sweat Jogging Bottoms



- 280gsm anti-pill fleece fabric
- Comfortable to wear, allowing maximum movement without restriction
- 2 hip pockets with zip closure
- Rear patch & cargo pockets on both legs all with velcro flaps
- Reinforced nylon knee patches
- Elasticated ankles
- S-3XL



BSJBYSO

BSJBYSY

EN ISO 20471



Code

**BSJBYSY** Yellow

**BSJBYSO** Orange

### Pulsar® Teflon Coated Combat Trousers



- Durable 275gsm
- Poly/cotton: 80% polyester 20% cotton
- Water repellent in light showers
- 3M Scotchlite reflective tape
- Knee pad pockets (pads not included)
- Partially elasticated waistband for comfort
- Double press stud & button with zip fly
- Ladies sizes available
- S-3XL



P346

PR336



EN ISO 20471



Code

**P346** Yellow

**PR336** Orange



### Hi Vis Two Toned Jogging Bottoms

- 100% polyester
- Brushed polyester warm lining
- Knee 300D reinforced Oxford denier area
- 2 side pockets with reflective tape for added visibility
- 2 thigh pockets & 1 back pocket, all with velcro fastening
- Elasticated ankle, perfect for fitting into boots
- Elasticated waistband with adjustable drawstring
- S-3XL



J9041

J9081

EN ISO 20471



1



Code

**J9041** Yellow / Navy

**J9081** Orange / Navy

### Hi Vis Two Toned Hooded Sweater

- 100% polyester
- Brushed polyester warm lining
- 3 piece hood design
- Lightweight birds eye hood lining
- Oversized kangaroo style pocket
- Adjustable drawcord around hood
- Rib cuff with thumb loop for extra comfort
- S-3XL



YN41

ON81

EN ISO 20471



2



Code

**YN41** Yellow / Navy

**ON81** Orange / Navy

### 7-in-1 Storm Coat



- 190gsm
- 300D breathable PU fabric
- Concealed hood
- Removable body warmer & sleeves
- S-3XL



EN ISO 20471



3

EN 343



3

Code

**S427** Yellow

### Traffic Jacket Grey / Yellow



- Waterproof PU coated polyester
- Hi visibility yellow with reflective tape
- Unique graphite panel design
- Quilt lined with internal lycra storm cuffs
- Full length zip with storm flap
- Velcro cuff adjustment
- Chin protector - fleece
- Chest pocket
- S-3XL



EN ISO 20471



3

EN 343



3

Code

**HVTRJGY** Grey / Yellow

HI VIS CLOTHING

**Bomber Jacket**



- 190gsm
- 100% polyester
- Padded lining
- S-4XL



HVBJY



HVBJO



EN ISO 20471 **3** EN 343 **3/1** RIS 3279 TOM ORANGE ONLY

Code

- HVBJY** Yellow  
**HVBJO** Orange

**Site Jacket**



- 190gsm
- 100% polyester
- Padded lining
- S-4XL



HVJY



HVJO



EN ISO 20471 **3/2** EN 343 **3/3** EN 342 **3** RIS 3279 TOM ORANGE ONLY

Code

- HVJY** Yellow  
**HVJO** Orange

**Breathable Bomber Jacket**



- 190gsm
- 100% polyester
- Breathable
- Lined collar for added warmth and comfort
- Concealed detachable hood
- S-3XL



HVBBJY



HVBBJO



EN ISO 20471 **3** EN 343 **3/3** RIS 3279 TOM ORANGE ONLY

Code

- HVBBJY** Yellow  
**HVBBJO** Orange

**Breathable Site Jacket**



- 190gsm
- 100% polyester, breathable 300D, Oxford Weave with a stain resistant finish, PU coated
- 100% polyester mesh lining
- Detachable hood
- Lined not padded
- S-3XL



HVBRJY



HVBRJO



EN ISO 20471 **3/2** EN 343 **3/3** RIS 3279 TOM ORANGE ONLY

Code

- HVBRJY** Yellow  
**HVBRJO** Orange

### Anorak with Orange Braces



- 300D waterproof PU coated polyester
- Warm quilt lining & lycra storm cuff
- Integral hood
- Mic loop
- Phone pocket
- Internal wallet pocket
- S-3XL



Code

**BA3RB** Yellow

### Bomber Jacket with Orange Brace



- 300D waterproof PU coated polyester
- Warm quilt lining & lycra storm cuff
- Integral hood
- Mic loop
- Multiple pockets
- ID pockets
- Phone pockets
- S-4XL



Code

**HV1782** Yellow

### Pulsar® Padded Storm Coat



- Class 3 waterproof & breathable 300 denier PU coated polyester outer fabric
- Padded with micro fleece collar for extra warmth & comfort
- 3M Scotchlite reflective tape & unique flip out ID window
- Full length YKK 2-way zip concealed by velcro storm flap with chin protector
- 3 pen pockets on left sleeve
- S-3XL



Code

**P187** Yellow

### Pulsar® 7-in-1 Yellow Storm Coat



- 300D fabric
- Removable inner body warmer
- Detachable hood
- Velcro storm flap & chin protector
- ID window
- Right chest waterproof zip pocket
- Multiple pockets
- Adjustable storm cuffs
- S-3XL



Code

**P487** Yellow

WEATHER PROOF CLOTHING

Nylon Rain Jacket

- 200gsm 100% polyester PVC coated
- 60gsm 100% polyester mesh yoke
- S-3XL



H4400

H440Y



Code

H440Y Yellow

H4400 Orange

Breathable Rain Jacket

- 185gsm
- Water & wind proof
- Breathable
- S-4XL



RTSO

S491



Code

S491 Yellow

RTSO Orange

Nylon Rain Trousers

- 200gsm
- 100% polyester PVC coated
- Elasticated waist
- S-5XL



HVOTO

HVOTY



Code

HVOTY Yellow

HVOTO Orange

Breathable Rain Trousers

- 185gsm
- Elasticated waist
- S-3XL



HVOTBO

S493



Code

S493 Yellow

HVOTBO Orange

WEATHER PROOF CLOTHING

**Pulsar® Waterproof & Breathable Trousers**

- 300D PU coated polyester fabric
- Fully waterproof
- 3M Scotchlite reflective tape
- Full length vertical stripes front & rear to show height in the wearer, increasing visibility
- Elasticated waistband & draw cord for a more precise fit
- S-3XL



PR503

P206



Code

**P206** Yellow

**PR503** Orange

**Executive Cargo Over Trousers**

- Fabric: LTEC 10,000 laminated polyester
- Breathable & waterproof
- Large velcro fastened cargo pockets
- Lower leg zip opening with velcro fastened storm flap
- Side pocket access
- Elasticated waist with shock cord adjuster
- S-3XL



HV1365

HV1355



Code

**HV1355** Yellow

**HV1365** Orange

**Hi Vis FR & Arc Protected Rain Jacket**

- Waterproof 8000mm
- High frequency welded seams
- Fixed hood with drawstring
- Zipped under storm flap with press studs
- Adjustable press stud on sleeves
- S-3XL



HW44

HW41



Code

**HW41** Yellow

**HW44** Orange

**Hi Vis FR & Arc Protected Rain Trousers**

- Waterproof 8000mm
- Flame retardant
- High frequency welded seams
- Adjustable press studs by the ankles
- Elasticated waist
- S-3XL



HW46

HW43



Code

**HW43** Yellow

**HW46** Orange

WEATHER PROOF CLOTHING

Sealtex Ultra Coverall



- 185gsm
- Sealtex ultra
- Water & windproof
- Breathable
- S-2XL



Code

S495 Yellow

Unlined Breathable Contrast Salopettes



- 190gsm
- 300D Oxford weave breathable fabric
- 60gsm 100% polyester mesh lining
- Stain resistant finish
- Phone pocket
- Double rule pocket
- S-3XL



HVBBO

HVBBY



Code

HVBBY Yellow

HVBBO Orange

Heavy Duty Hi Vis Wet Suit

- 170gsm 100% polyester PVC
- 60gsm 100% polyester mesh yoke
- S-3XL



Code

HVOT440Y Yellow

### Light Duty 2 Piece Wet Suit

- Yellow
- Underarm vents & vent holes to prevent water ingress
- Zipped front with studded overlap
- Includes hood with neck cord
- Twin jacket pockets
- M-2XL



Code

CLWS

### Heavy Duty Wet Suit Trousers & Jacket

- Concealed hood
- Access for side pockets with flaps
- Available in yellow & navy
- Studded cuff
- Elasticated waist
- Hip draw cord
- Stud ankle adjustment
- S-3XL



Code

<b>CLWSHDSY</b>	Yellow	Trousers & Jacket
<b>CLWSHDTY</b>	Yellow	Trousers only
<b>CLWSHDJY</b>	Yellow	Jacket only
<b>CLWSHDSB</b>	Navy	Trousers & Jacket
<b>CLWSHDTB</b>	Navy	Trousers only
<b>CLWSHDJB</b>	Navy	Jacket only

**BEST  
SELLER**

## THE LEO WORKWEAR WOMENS RANGE

-EMPOWERING WOMEN TO WORK SAFELY



The most comprehensive range of womens high visibility clothing.



**FOCUSED ON FIT**  
**FOCUSED ON QUALITY**



Womens Polycotton Trousers



- Triple Stitched Main Seams
- Quadruple Stitched Reflective Tape
- Cargo Style Leg Pockets with Reflective Piping
- Internal Knee Pad Pockets
- Back Pocket
- Side Waist Elastic
- 7 Belt Loops
- UK Sizes: 8-26



HVOWT

HVVWT



Code

HVVWT Yellow

HVOWT Orange

Womens Breathable Jacket



- Polyester Mesh Lined Body & Sleeves
- Full Length Hook & Loop fastened Storm Flap
- Micro Fleece Lined Collar
- Zip Detachable Hood
- Zipped Hand Warmer Front Pockets Two Internal Drop Pockets
- Nelson Pocket
- Cuff Adjusters
- UK Sizes: 6 - 22



HWWLPSY

HWWLPSO



Code

HWWJY Yellow

HWWJO Orange

Womens Polo Shirt



- Hydrophobic fabric draws moisture to the outer where it is evaporated
- Split hem design with extended back
- 3 button placket with contrast grey lining and buttons
- Anti-microbial for protection against the build up of bacteria and odour
- Soft handle fabric prevents irritation
- Segmented reflective tape for garment stretch and improved breathability
- UV protection to UPF40+ meeting EN13758-2
- Tested to 50 wash cycle
- UK Sizes: 8-26



HWWPSO

HWWPSY



Code

HWWPSY Yellow

HWWPSO Orange

Womens Sleeved Polo Shirt



- Hydrophobic fabric draws moisture to the outer where it is evaporated
- Split hem design with extended back
- 3 button placket with contrast grey lining and buttons
- Anti-microbial for protection against the build up of bacteria and odour
- Soft handle fabric prevents irritation
- Segmented reflective tape for garment stretch and improved breathability
- UV protection to UPF40+ meeting EN13758-2
- Tested to 50 wash cycle
- UK Sizes: 8-26



HWWLPSO

HWWLPSY



Code

HWWLPSY Yellow

HWWLPSO Orange

# PPE Recycling

Secure  
Sustainable  
Solutions

CMT has teamed up with one of the UK's leading secure destruction specialists to provide a nationwide service for the secure destruction and recycling of all types of PPE. As well as improving your carbon footprint and protecting the environment, this service can also be used as a secure way to protect your brand. All materials can be collected from your site and taken to a secure facility where it is destroyed by shredding and recycled.



**1** Order your recycling station with one of our sales team using code: **SBRP**



**3** Choose either a 1, 2 or 4 week collection time frame and we will collect the bin and take the items to a secure recycling facility

**2** We deliver your recycling point to your chosen delivery address.

**4** We will provide you with a Certificate of Destruction if required, giving you peace of mind

Footwear



Hearing Protection



Eyewear



Gloves



Helmets



Respiratory Equipment



Workwear



Working in conjunction with our Charity Partners some of the unbranded garments can be sent out to 3rd world countries in support of less fortunate communities

CMT embraces the circular economy concept, whereby we keep resources in use for as long as possible, extract the maximum value from them whilst in use, then recover and regenerate products and materials at the end of each service life.

Contact our team  
**020 8311 1144**

Licensed Waste Carrier No. CBDL318836

### 3 Part Polyester Vests

- 100% knitted polyester
- 69cm long
- S-3XL



1290V



1290Z



RIS 3279  
TOM



Code

**1290V** Orange 3 part polyester vest - velcro front, side & shoulders

**1290Z** Orange 3 part polyester vest - zippered front, velcro side & shoulders

### London Underground Vest



- Tested & certified to EN510
- Anti-entanglement
- Press stud front, velcro sides & shoulders
- S-2XL



EN ISO 20471



RIS 3279  
TOM



Code

**HVWRU** Orange

### 3 Part Polyester Vest Zip & Stud



- Zip front, studded side & shoulder
- 75cm long
- Anti-entanglement
- S-3XL



EN ISO 20471



RIS 3279  
TOM



Code

**HVWRO** Orange

RAIL CLOTHING - RIS 3279 TOM

Pulsarail™ Short Sleeved Polo Shirt



- 100% polyester birds eye knit fabric with added wicking treatment for extra comfort
- Solar protection factor (SPF) rating 50+
- S-3XL



pulsarail™



RIS 3279 TOM

Code

PR176 Orange

Pulsarail™ Long Sleeved Polo Shirt



- 100% polyester birds eye knit fabric with added wicking treatment for extra comfort
- Solar protection factor (SPF) rating 50+
- Knitted collar & cuffs
- S-3XL



pulsarail™



RIS 3279 TOM

Code

PR470 Orange

Short Sleeved Polycotton Polo Shirt



- 175gsm
- 100% polyester birds eye knit fabric with added wicking treatment for extra comfort
- Solar protection factor (SPF) rating 50+
- S-3XL



RIS 3279 TOM

Code

HVPSO Orange

Long Sleeved Polo Shirt



- 175gsm
- Poly/cotton double knitted: 75% polyester 25% cotton
- Certified to the UV Protective Clothing Standard EN13758-2, UPF 40+
- Wicking polyester fibres channel moisture away from the body
- Solar protection factor (SPF) rating 50+
- Elasticated cuff
- S-3XL



RIS 3279 TOM

Code

HVLPSO Orange

Classic Sweatshirt



- 300gsm
- Poly/cotton: 65% polyester 35% cotton
- Ideal when it's too cold for a T-Shirt but too warm for a jacket
- Hard-wearing, functional & comfortable
- Elasticated waistband & cuffs
- S-3XL



RIS 3279 TOM

Code

HVSSO Orange

Classic T-Shirt



- 150gsm
- 100% polyester birds eye knit
- Lightweight, breathable & extremely comfortable
- S-4XL



RIS 3279 TOM

Code

HVTSO Orange

**Pulsarail™ Waterproof Coverall**



- 300D PU coated 100% polyester fabric
- 100% polyester mesh lining
- Thinsulate liner available (**G100COV** see below)
- Unique design underarm ventilation system
- Modern sports style waterproof zip away lined arctic style hood with draw cord
- Elasticated waistband for a more precise fit
- S-3XL



pulsarail™



Code

**PR505** Orange

**Pulsarail™ Waterproof Over Trousers**



- 300D PU coated polyester fabric
- Full length vertical reflective 3M stripes front & rear to show height in wearer, increasing visibility
- Rear & thigh pockets with reflective piping details on flaps
- Gusseted at hem of legs for ease over boots with waterproof zips to help prevent excess dirt forming
- S-3XL



pulsarail™



Code

**PR503** Orange

**Flame Retardant & Anti Static Waterproof Salopettes**

- 250gsm
- BizFlame rain material
- Waterproof & breathable
- Unlined
- S-2XL



Code

**HW25** Orange

**Thinsulate Liner for Pulsarail Coverall**

- Suits PR505 coverall (see above)
- 3M Thinsulate Insulation Type G100 quilting for maximum heat retention & comfort
- 5 anchorage points at the ankles, cuffs & back of neck
- Knitted cuffs & ankles
- YKK zip
- S-3XL



Code

**G100COV** Grey

RAIL CLOTHING - RIS 3279 TOM

Polycotton Coverall



- 280gsm
- Poly/cotton: 80% polyester 20% cotton
- Texpel stain resistant finish
- Phone & rule pockets
- Side access pockets
- Mobile phone pocket
- Back elastic for ease of movement
- S-3XL

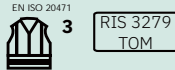

Code

RT42 Orange

Polycotton Bib & Brace



- 280gsm
- Poly/cotton: 80% polyester 20% cotton
- Texpel stain resistant finish
- Phone & rule pocket
- Zipped security pocket
- Side access pocket
- 7 pockets for ample storage
- Ergonomic kneepad pocket
- S-3XL



Code

HVBBPO Orange

Polycotton Cargo Trousers



- 280gsm
- Poly/cotton with water & stain repellent finish
- Triple stitched main seams
- Metal button fastener & YKK zip fly
- See page 264 for other colours
- Available in short, regular & tall
- S-4XL

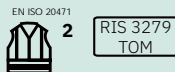

Code

HVOPT Orange

Pulsarail™ Teflon Combat Trousers



- Durable 275gsm
- Poly/cotton: 80% polyester 20% cotton fabric with twill finish
- S-3XL



Short	30-44
Reg	28-50
Tall	28-46



Code

PR336 Orange

**Pulsarail™ Polycotton Coverall**



- 275gsm
- Poly/cotton:  
80% polyester  
20% cotton twill
- Knee pad pockets  
(pads not included)
- S-3XL

**pulsarail™**

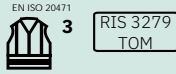

Code

**PR339** Orange

**Pulsarail™ Breathable Bomber Jacket**



- Microfleece collar for extra warmth & comfort
- Full length YKK 2-way zip concealed by velcro storm flap with chin protector
- Zipaway detachable lined hood
- 3 pen pockets on left sleeve with embroidered eyelets for water expulsion
- Sports style waterproof zip pocket to right chest ideal for mobile phones
- S-3XL

**pulsarail™**



Code

**PR515** Orange

**Pulsarail™ Unlined Storm Coat**



- Sports style waterproof zip pocket to right chest ideal for mobile phone
- Interactive internal zips to accommodate either **PR498** (Sleeved body warmer) **PR508** (Polar fleece) or **PR535** (Soft-shell jacket) available to order
- S-3XL

**pulsarail™**



TO ORDER  
2-3 DAY  
DELIVERY



Code

**PR499** Orange

**Pulsarail™ 7-in-1 Jacket**



- 300D PU fabric
- Removable inner body warmer
- Detachable hood
- Micro fleece collar
- Velcro storm flap & chin protector
- ID window
- Right chest waterproof zip pocket
- Multiple pockets
- Adjustable storm cuffs
- S-3XL

**pulsarail™**



Code

**PR497** Orange

RAIL CLOTHING - RIS 3279 TOM

Hi Vis Contrast Softshell Jacket



- 94% polyester  
6% spandex
- Water resistant & breathable
- Waterproof zips
- Multiple pockets
- S-4XL



RIS 3279  
TOM

Code

HV2110 Orange

Bodywarmer PU Coated Polyester



- 300D PU coated polyester
- Warm quilt lining & water repellent outer fabric
- YKK front zip
- Mobile phone pocket
- Front storage & hand warmer pockets
- S-3XL



RIS 3279  
TOM

Code

HVBWO Orange

Breathable Bomber Jacket



- 190gsm
- 100% polyester
- Breathable
- Lined collar for added warmth and comfort
- Concealed detachable hood
- S-3XL



RIS 3279  
TOM

Code

HVBBJO Orange

Breathable Site Jacket



- 190gsm
- 100% PU coated polyester, breathable 300D Oxford weave with a stain resistant finish
- 100% polyester mesh lining
- Lined not padded
- Detachable hood
- S-3XL



RIS 3279  
TOM

Code

HVBRJO Orange



## Complete Lookout Kit

Lookout holdall, chequered flag, red flag, flag poles x 2, detonators (fog signals) x 6, plastic detonator case, chain for whistle, whistle, complete horn, hand lantern, red lens aspect, 6 volt battery, track circuit clip, 1 person first aid kit, lookout armlet, site warden armlet



Code

TSCLK

## Hand Signalman Kit

Handsignal holdall, red flag, green flag, yellow flag, flag poles x 3, hand lantern, red lens aspect, orange lens aspect, green lens aspect, 6 volt battery



Code

TSHSK

## Level Crossing Attendant Kit

Level crossing holdall, red flag, green flag, flag poles x 2, hand lantern, red lens aspect, orange lens aspect, green lens aspect, 6 volt battery x 5, maxi-lite red lens x 2



Code

TSLCAK

## Torches & Aspects

- LED floating lantern
- 300 lumens
- 10 hours run time
- 250m range
- 6 volt battery **EB6V** not included (See page 164)



Code

UK47 Torch

TS010 Red lens aspect

TS011 Green lens aspect

TS012 Orange lens aspect

TS013 Blue lens aspect

## RAIL ACCESSORIES

### Detonators & Cases

- Coin sized
- To be placed on top of the rail
- Triggered by pressure rather than impact so safe to transport
- Loud warning to train drivers



Code

- TS001** Detonators
- TS002** Plastic detonator case

### Flags & Poles



Code

- TS004** Flag pole 54"
- TS005** Chequered flag
- TS006** Red flag
- TS007** Green flag
- TS008** Yellow flag

### Armlets with Inserts

- If you do not see the armband you are looking for please ask



Code

- TSA001** Lookout
- TSA002** Site warden
- TSA003** COSS
- TSA004** Machine controller
- TSA005** Crane controller
- TSA006** Engineering supervisor
- TSA007** Protection controller
- TSA008** Site person in charge

### Level Crossing Lamp

- MaxiLite red lens



Code

- LRSMXLR**

# FOR EVERYTHING EMBROIDERY

DON'T FORGET

SEE PAGE 333



## Classic Polo Shirt

BRANDit

- 220gsm
- Poly/cotton: 50% polyester 50% cotton
- Knitted collar, hemmed sleeve & bottom
- Taped neck
- 3 self coloured button placket
- Reactive dyed, washable at 60 degrees
- Stock colours: black, navy, charcoal & royal blue (other colours available to order)
- XS-4XL



Code	
CLPS-BLK	Black
CLPS-NAV	Navy
CLPS-CHA	Charcoal
CLPS-RBL	Royal blue

## Classic T-Shirt

BRANDit

- 180gsm
- 100% cotton
- Crew neck
- Twin needle stitching on neck & shoulders
- Taped shoulder to shoulder
- Reactive dyed
- Stock colours: black, navy & red (other colours available to order)
- XS-4XL



Code	
CLTS-BLK	Black
CLTS-NAV	Navy
CLTS-RED	Red

WORKWEAR

Premium T-Shirt



- 200gsm
- 100% cotton
- Crew neck
- Twin needle stitching on neck & shoulders
- Taped shoulder to shoulder
- Reactive dyed
- Stock colours: black & navy (other colours available to order)
- S-3XL



Code

CLPTS

Long Sleeved Polo Shirt



- 220gsm
- Poly/cotton: 50% polyester 50% cotton
- Knitted collar, hemmed sleeve & bottom
- 3 self coloured button placket
- Reactive dyed, washable at 60 degrees
- Stock colours: black, navy & red (other colours available to order)
- XS-4XL



Code

CLPSL

Jersey Polo Shirt



- 190gsm
- 100% cotton
- Knitted collar, hemmed sleeve & bottom
- Taped neck
- 3 self coloured button placket
- Reactive dyed, washable at 60 degrees
- Stock colours: black & navy (other colours available to order)
- XS-3XL



Code

CLJPS

**Oxford Weave Shirt - Short Sleeves**



- 120gsm
- Easy iron material
- Poly/cotton: cotton rich 70% cotton 30% polyester
- Collar size 15" - 20"



Code

**KK350-WHT** White

**KK350-SB** Sky blue

**Oxford Weave Shirt - Long Sleeves**



- 120gsm
- Easy iron material
- Poly/cotton: cotton rich 70% cotton 30% polyester
- Collar size 15" - 20"



Code

**KK351-WHT** White

**KK351-SB** Sky blue

**Classic Sweatshirt**



- 300gsm
- Poly/cotton: 50% cotton 50% polyester
- Lycra ribbed cuffs, welt & neck
- Stock colours: black, navy, charcoal & royal blue (other colours available to order)
- XS-4XL



Code

**CLSS-BLK**

**CLSS-NAV**

**CLSS-CHA**

**CLSS-RBL**

**Classic Hooded Sweatshirt**



- 300gsm
- Poly/cotton: 50% cotton 50% polyester
- Taped neck, lycra ribbed cuffs & welt
- Double fabric hood, front pouch pocket
- Brushed effect for superior comfort & look
- Available with or without self coloured full zip
- Reactive dyed
- Stock colour: navy (other colours available to order)
- S-3XL



UC501

UC504

Code

**UC501** No zip

**UC504** Full zip

WORKWEAR

Apache Softshell Jacket



- 94% polyester 6% spandex
- Micro fleece lined
- Water repellent & breathable
- Zipped pockets
- Velcro adjustable cuffs & draw cord waist
- Black
- M-2XL



Code  
APSSHELL

Technik Softshell Jacket



- 310gsm
- 94% polyester 6% spandex
- Laminated micro polar fleece
- Windproof, water resistant, breathable membrane
- Mobile phone pocket
- Stock colours: black & navy
- S-4XL



Code  
TK50

Standard Fleece



- 300gsm
- 100% polyester super anti-pill micro fleece
- 2 zip pockets
- Stock colours: black, navy & red
- XS-4XL



Code  
CLFJ

Premium Full Zip Softshell Jacket



- 325gsm
- 3 layer 10000mm bonded fabric
- Mid layer: TPU waterproof, breathable & windproof membrane
- Outer layer: 93% polyester 7% elastane
- Inner storm flap
- Inner pouch & phone pockets
- Fully adjustable cuffs
- Adjustable hem with toggles
- XS-3XL



Code  
UC611

Apache All Season Work Jacket



- Lightweight, highly water repellent PU coated jacket with incredibly warm fleece lining
- Removable hood
- Two tone with reflective piping
- Zipped pockets
- Velcro adjustable cuffs & draw cord waist
- Black
- M-2XL



Code  
APASWJ

Regatta Red/Grey Jacket





- Anorak
- Reflective tape
- Lycra storm cuff
- Full length hook & loop-fastened storm flap
- Hood in collar
- Drop tail back
- Mobile phone pocket
- Internal wallet pocket



Code  
HVJYBA3-RG

### Iona Safety Combat Trouser

- 245gsm
- Kingsmill fabric
- Knee pad pocket (pad not included)
- Stock colours: black, navy

		
<b>Reg</b>	S-4XL	S-2XL
<b>Tall</b>	S-2XL	n/a



BRAND 





Code

**S917**

### Action Trouser

- 245gsm
- Kingsmill fabric
- Reinforced at seat & knee
- Knee pad pocket (pad not included)
- Multiple zip pockets
- Stock colours: black & navy (other colours available to order)
- S-3XL

		
<b>Short</b>	28-48	30-44
<b>Reg</b>	28-48	28-48
<b>Tall</b>	28-48	28-48



BRAND 

Code

**S887**

### Ballistic Trousers 3/4 Protection

- Navy
- Sizes: short, regular & tall
- S-2XL



BRAND 

Code

**TRBLT**

WORKWEAR

Action Trouser  
Car Safe

- 245gsm
- Poly/cotton: 65% polyester 35% cotton
- Triple stitched on all main seams for ultimate strength
- Multifunctional & hardwearing
- Internal knee pad pocket (pad not included)
- Multiple pockets with extra strong lining
- Stock colours: navy, black (other colours available to order)



<b>Short</b>	30-42	28-48
<b>Reg</b>	30-42	28-48
<b>Tall</b>	30-40	30-44



BRAND 

**BEST  
SELLER**

Code

CLATNZ

Standard Boiler Suit  
with Zip

BRAND 

- 345gsm
- Top quality pre-shrunk Kingsmill fabric
- Various pockets & a hammer loop
- Navy
- S-3XL



Code

PRICE EACH

C813

Standard Boiler Suit  
with Poppers

BRAND 

- Polycotton: 65% polyester 35% cotton
- Concealed stud front
- Various pockets including rule pocket
- Elastocated waist
- Navy
- S-4XL



Code

CLBS



### Disposable Coverall Type 5/6

- Type 5/6
- Elasticated hood, wrists & ankles
- Colours: white & navy
- White S-4XL  
Flame L-3XL  
retardant
- Navy M-2XL  
Orange M-2XL

ENQUIRE FOR BULK RATES



Code		
<b>CLDCV-WHT</b>	White	50
<b>CLDCVFR</b>	Flame retardant	50
<b>CLDCV-NAV</b>	Navy	50
<b>STCLDCV-ORA</b>	Orange	50

### 3M Disposable Coverall

- Excellent protection against dust & certain liquids
- Taped deams for additional protection
- Elasticated waist & ankles for convenience & freedom of movement
- Elasticated hood with three panel design
- Knitted cuffs for increased comfort
- Two-way zipper with sealable storm flap
- Offers protection against certain biohazards
- Low linting
- Colours: white & blue
- White M-3XL  
Blue M-XL



Code	
<b>3M4565</b>	White
<b>3M4530</b>	Blue

### Tyvek™ Disposable Coverall Blue Panel

- Chemical protective clothing, Category III, Type 5-B & 6-B
- Stitched external seams featuring patent-pending technology for enhanced liquid spray tightness
- Very low inward leakage thanks to optimised design
- Tyvek™ auto-lock zipper & zipper flap for increased protection
- White
- L-2XL



Code	
<b>CLTYVEK</b>	

### Microporous Shoe Cover Type 6B

- One size fits all
- Blue
- Pack of 100



Code		
<b>CLOV</b>		100

WORKWEAR

Knitted Beanie



- Outer fabric 100% soft touch acrylic
- Double layer knit
- One size fits all
- Black, navy & grey



Code

- CLBN-BLK
- CLBN-NAV
- CLBN-GRY

Baseball Cap



- One size (Adjustable strap)
- Black & navy available



Code

- B010CAP-BLK
- B010CAP-NAV

Mesh Ear Balaclava

- Double thermal layer
- Mesh ear design accordance with Network Rail requirements
- Moisture wicking and quick dry fabric



Code

TSXUT30

Surefit Thermal Helmet Liner



- Deep edges to cover the entire ear
- Stretchy material provides a tight fit



Code

SFITBN



144



BEANIES EMBROIDERED

NEXT DAY DELIVERY



KNEE PROTECTION

Lightweight Kneepad

- Nylon construction
- EVA foam
- Black



Code

KP20

Standard Kneepads

- Allows user to move with confidence on their knees while working
- Strong outer shell protects your knee from sharp objects



Code

CLKP

Professional Gel Kneepads

- Gel cushion acts as a shock absorber for your joints
- Flexible and wide footprint gives the wearer stability



Code

CLGKP

Trousers Insert Kneepad

- Suitable for work trousers with internal pockets (see Hi Vis Clothing & Workwear section)
- 21.5 x 16.5cm
- Can be cut to size



Code

S156

# ARC FLASH & FLAME RESISTANT CLOTHING

Make the smart choice for Arc Flash and Flame Resistant garments.

100%

**100% INHERENT**



**LIFETIME SEAM GUARANTEE**

ThermSAFE™

**THERMSAFE COMPONENTS**



## Combined Ebt/ATPV Ratings

Garments can be layered to achieve an overall Arc Thermal Performance Value (ATPV) or Energy Break open Threshold (Ebt) rating. For example, thermals may achieve an Ebt of 4.3 Cal/cm<sup>2</sup>, and an outer coverall may achieve an ATPV of 13.6 Cal/cm<sup>2</sup>. However the combination ATPV will be greater than the sum of the two single layers, as the air gap between the two layers affords the wearer additional protection.



+



+



=

**33**  
**CAL**

HW10/11

HW14

HW60

**= 33 Cal**

# THE IMPORTANCE OF FLAME RETARDANT CLOTHING

## WHAT MAKES FR CLOTHING DIFFERENT?

- Self extinguishes or resists ignition
- Does not melt onto skin
- Provides thermal insulation from heat
- Resists breaking and exposing skin
- Reduces burn injury & increases chance of survival

## THE COST OF A SINGLE BURN INJURY CAN BE MORE THAN THE COST OF AN ENTIRE FLAME RETARDANT CLOTHING PROGRAMME

If workers are in a dangerous environment where heat & flame are present, it's in the employer's responsibility to ensure they are protected.

FR clothing is an investment; not only does it help prevent the potentially huge costs of an incident occurring, it is also better quality & lasts longer than standard clothing, leading to savings in the long term.



## KEY TO SYMBOLS



Waterproof



Anti-static



Breathable



Water repellent



Flame retardant



Arc flash protected

## FLAME RETARDANT EN STANDARDS



### EN ISO 14116

Protective clothing against heat & flame. Limited flame spread materials



### EN ISO 11612

Protection clothing against flame



### EN ISO 13034

Protective clothing against liquid chemicals



### EN 1149-3 / EN 1149-5

Protective clothing with electrostatic properties



### EN 61482-1-2

Protection against electric arc flashes



### EN ISO 11611

For use in welding & allied processes



### EN ISO 13506

Manikin test

## EN STANDARDS FOR SAFETY WORKWEAR GUIDE



**3** EN ISO 20471  
High visibility clothing



### EN ISO 11611

Protection against infective agents



### EN ISO 1073-2

Protection against radioactive contaminants



### ISO EN 13982

Protection against solid particulates



### EN ISO 343

$\frac{3}{1}$  Breathable, wind & waterproof clothing



### EN ISO 342

$\frac{3}{2}$  Certified Protection against cold



### UV Standard 801

Protection from UV rays

FLAME RETARDANT CLOTHING

FR & AS Long Sleeve Polo Shirt



- 200gsm
- Inherently flame retardant fabric
- Stock colours: black & navy
- S-5XL



Code

HW10

FR & AS Long Sleeve T-Shirt



- 200gsm
- Inherently flame retardant fabric
- Navy
- S-3XL



Code

HW11

FR & AS Leggings



- 200gsm
- Stock colours: black & navy
- S-4XL

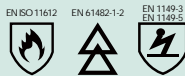

Code

HW14

FR & AS Sweatshirt



- 200gsm
- Navy
- S-3XL



Code

HW12

FLAME RETARDANT CLOTHING

Heavy Duty FR Trousers



- 325gsm
- 100% cotton
- FR coating to EN470 & EN531
- Zip fly
- Two swing pockets to front
- Rear patch pocket
- Map pocket with flap
- Button waist
- Navy
- Regular leg



Reg	S-4XL
Tall	S-3XL

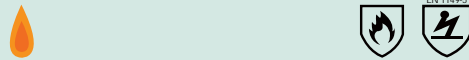

Code

HW15

Standard FR Trousers



- 325gsm
- 99% cotton, 1% carbon fibre
- Very comfortable & breathable fabric
- Triple stitched seams
- Radio loops
- Hi-Vis stripes can be added
- Elasticated waist
- Sizes regular & tall
- Navy



Reg	S-4XL
Tall	S-3XL

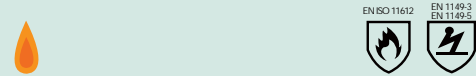

Code

HW16

FR Boiler Suit



- 330gsm
- Radio loop
- Side elastic waist
- Navy
- Regular & tall
- S-3XL



Code

HW17

Super Lightweight FR & AS Coverall



- 210gsm
- Knee pad pockets
- Sleeve pocket
- Radio loop
- Colours: Navy & orange
- S-4XL



Code

HW21

FLAME RETARDANT CLOTHING

FR  
Coverall

- 330gsm
- Knee pad pockets
- Phone pockets
- Radio loop
- Colours:  
Red & orange
- Regular & tall



<b>Reg</b>	S-3XL	S-3XL
<b>Tall</b>	M-XL	M-XL



HW20

HW27



Code

HW20 Red

HW27 Orange

Hi-Vis FR & AS  
Multinorm Coverall

- 330gsm
- Knee pad pocket
- Radio loops
- Stud adjustable cuffs
- Yellow/Navy
- S-4XL



Code

HW19



**FR Waistcoat**  
3/4 Sleeve

- 100% knitted polyester
- 3/4 length sleeve
- Velcro fastener
- Length 77cm
- Hook & loop fastener
- S-3XL



BRAND **it**

EN ISO 20471

EN ISO 11612



Code

**HW26**

**FR Waistcoat**  
Long Sleeve

- 250gsm
- Bizflame rain
- Hook & loop fastener
- Quick release buckles
- Yellow or orange
- S-3XL



BRAND **it**

EN ISO 20471

EN 533  
Level 1



Code

**HW32** Yellow

**HW33** Orange

HW33

HW32

**FR & AS Waterproof**  
Salopettes

- 250gsm
- Bizflame rain
- Unlined (lined version available)
- Waterproof & breathable
- Quick release buckles
- Back waist buggy for added protection
- Yellow S-3XL
- Orange S-2XL

HW25



HW24



BRAND **it**

EN ISO 20471

EN 343

EN ISO 11612

EN 1149-3  
EN 1149-5



Code

**HW24** Yellow

**HW25** Orange

FLAME RETARDANT CLOTHING

Hi-Vis  
FR Trouser

- Inherently flame retardant fabric
- Orange
- Regular & tall



Reg S-4XL

Tall S-3XL



Code

BIZ30HV-ORN

Hi-Vis  
FR & AS Trouser

- 320gsm
- "TESLA" trousers
- 2 bands retro reflective tape to legs
- Plain ankles
- YKK brass zip fly
- Brass hook & bar waistband fastening
- 7 belt loops
- Two vertical side seam access pockets
- Yellow
- Regular & tall
- S-4XL



Reg 30-46

Tall 30-42



Code

HW54

Hi-Vis & FR  
Rain Trousers

- High frequency welded seams
- Waterproof: 8000mm
- Flame retardant Hi-Vis trousers
- Elasticated waist
- Adjustable press stud by ankles
- S-3XL

HW46



HW43



Code

HW43 Yellow

HW46 Orange

**Hi-Vis & FR  
Rain Jacket**

- High frequency welded seams
- Waterproof: 8000mm
- Fixed hood with drawstring
- Zipper under storm flap with press studs
- Adjustable press stud on sleeves
- S-3XL



HW41

HW44



Code

**HW41** Yellow

**HW44** Orange

**DON'T FORGET  
TO SPECIFY  
SIZE & COLOUR  
OF GARMENTS  
WHEN YOU  
PLACE AN  
ORDER**



ORDER **6AM TO 7PM** FOR NEXT MORNING DELIVERY

Set up an account for our discounted rates / prices

ARC & FLAME RETARDANT CLOTHING

ProGARM FR, AS & ARC Trousers



- 320gsm
- ThermSAFE™ plastic FR zipper
- Combat pocket with flap
- Side access pockets with flaps
- Kneepad pockets
- Short, regular & tall
- S-4XL



<b>Short</b>	32-42
<b>Reg</b>	30-52
<b>Tall</b>	32-44



Code

PG7418

Pulsar® FR, AS & ARC Combat Trousers



- 310gsm
- Aramid thread used throughout
- Internal knee pad pockets
- Short, regular & tall
- SM-3XL



<b>Short</b>	30-44
<b>Reg</b>	28-50
<b>Tall</b>	30-44



RIS 3279 TOM

Code

PRARC07

Hi-Vis Multinorm FR, AS & ARC Coverall



- 345gsm
- Bizflame multi fabric
- Concealed side access pockets & rule pockets
- Knee pad pockets
- S-3XL



EN ISO 20471

EN ISO 11612

EN 61482-1-2

EN 13034

EN 1149-3 EN 1149-5

EN ISO 11611



Code

HW60

Pulsar® FR, AS & ARC Combat Coverall



- 310gsm
- Aramid thread used throughout
- Internal knee pad pockets
- Racing suit style collar & fastening
- S-4XL



EN ISO 20471

EN ISO 11612

EN 61482-1-2

EN 1149-3 EN 1149-5

EN ISO 11611



RIS 3279 TOM

Code

PRARC05

## Hi-Vis Long Sleeve FR, AS & ARC Polo Shirt **BRANDit**

- 210gsm
- Modafume knitted fabric
- Flame retardant tape
- Arc rated
- S-4XL



Code

**HW28**

## Hi-Vis Long Sleeve FR, AS & ARC Polo Shirt **BRANDit**

- 60% Protal, 38% Viloft, 2% anti-static fibres
- Inherently flame retardant
- Fashion knit collar & 3 button placket
- Elasticated knitted FR cuffs
- S-3XL



Code

**HW29**

## ProGARM FR & ARC Sweatshirt **BRANDit**

- Arc flash protected
- Brushed fleece inner
- Breathable
- Arm pocket for phone or small items
- S-4XL



Code

**PRO5648**

## Hi-Vis FR, AS & ARC Sweatshirt **BRANDit**

- 300gsm
- Modafume knit
- Inherently fire resistant material
- Snug rib knit cuffs
- S-3XL



Code

**HW30**

ARC & FLAME RETARDANT CLOTHING

Hi-Vis FR & ARC Protected Rain Jacket BRAND **it**

- High frequency welded seams
- Waterproof: 8000mm
- Fixed hood with drawstring
- Zipper under storm flap with press studs
- Adjustable press stud on sleeves
- S-3XL



Code  
**HW41** Yellow  
**HW44** Orange

Hi-Vis FR & ARC Protected Rain Trousers BRAND **it**

- High frequency welded seams
- Waterproof: 8000mm
- Flame retardant Hi-Vis trousers
- Elasticated waist
- Adjustable press stud by ankles
- S-3XL



Code  
**HW43** Yellow  
**HW46** Orange

Hi-Vis Multinorm FR, AS & ARC Jacket BRAND **it**

- 345gsm
- 99% cotton, 1% carbon fibre
- Triple stitched seams
- Very comfortable & breathable fabric
- Radio loops
- Yellow/navy
- S-3XL



**HW10 or HW11** + **HW14** + **HW61 & HW62** = 33 CAL  
 Code  
**HW61**

Hi-Vis Multinorm FR, AS & ARC Trouser BRAND **it**

- 345gsm
- 99% cotton, 1% carbon fibre
- Triple stitched seams
- Very comfortable & breathable fabric
- Two tir knee pad pockets
- Elasticated waist
- Yellow/navy
- S-2XL



**HW10 or HW11** + **HW14** + **HW61 & HW62** = 33 CAL  
 Code  
**HW62**

## ProGARM FR, AS & ARC Trouser

- 320gsm triple stitched seam
- ThermSAFE™ flame resistant zip
- Kneepad & phone pockets
- Combat & side access pockets with flaps
- Short, regular & tall



PG4616

PG7418



Code

**PG7418** Yellow

**PG4616** Orange

## ProGARM Linesman FR, AS & ARC Coverall

- 240gsm
- Triple stitched on all main seams
- Vertical zip chest pockets
- Kneepad pockets
- Side access pockets with flaps
- Mobile phone pocket
- Expandable ankle opening with zippers
- S-4XL



Code

**PG6458**

## ProGARM FR, AS & ARC Coverall

- 360gsm
- GO/RT
- Chest pockets with zippers
- Kneepad pockets
- Side access pockets with flaps
- Mobile phone pocket
- Velcro secured cuff tabs
- S-4XL



Code

**PG4690**

ARC & FLAME RETARDANT CLOTHING

ProGARM FR, AS & ARC Polo Shirt

- VXS+ blend - natural feel, comfortable & soft
- ThermaSAFE™ plastic flame resistant poppers - CE certified
- Rib knit cuffs - close fit
- S-4XL



PG5290



PG5286



Code

PG5286 Yellow

PG5290 Orange

ProGARM FR, AS & ARC Trousers

- 250gsm
- Triple stitched seams
- Combat pocket with flap
- Kneepad pockets
- Mobile phone pocket
- Side access and rear pockets
- Short, regular & tall

<b>Short</b>	30-52
<b>Reg</b>	30-52
<b>Tall</b>	30-52



Code

PG7638

FR & ARC Gloves

- 13 gauge knitted liner Kevlar® Modacrylic & fibreglass
- Sponge neoprene coating
- L-XL



Code

HW45



# FIXINGS & FASTENERS



Nails & Screws	<b>384-385</b>
Screwdriver Bits & Drill Chucks	<b>386-387</b>
Chemical Anchor Studs & Accessories	<b>388</b>
Chemical Anchor Resin Overview	<b>389</b>
Chemical Anchor Resins	<b>390-393</b>
Masonry & Steel Fixings	<b>394</b>
Sleeve & Wedge Anchors	<b>395</b>
Multi Fixing Bolts & Threaded Bars	<b>396</b>
Bolts	<b>397</b>
Nuts & Washers	<b>398</b>
Site Ironmongery	<b>399-400</b>

## NAILS & SCREWS

### Bright Round Wire Nails

- 25kg box

**BEST SELLER**



Code		
<b>HDN1</b>	length 25mm	1
<b>HDN15</b>	length 40mm	1
<b>HDN2</b>	length 50mm	1
<b>HDN25</b>	length 65mm	1
<b>HDN3</b>	length 75mm	1
<b>HDN4</b>	length 100mm	1
<b>HDN5</b>	length 125mm	1
<b>HDN6</b>	length 150mm	1

### Nails for Hilti Gun Nailer

- Box of 100



Code		
<b>TN19K</b>	length 19mm	1
<b>TN22K</b>	length 22mm	1
<b>TN27K</b>	length 27mm	1
<b>TN32K</b>	length 32mm	1
<b>TN37K</b>	length 37mm	1
<b>TN42K</b>	length 42mm	1
<b>TN47K</b>	length 47mm	1
<b>TN52K</b>	length 52mm	1
<b>TN62K</b>	length 62mm	1
<b>TN72K</b>	length 72mm	1

### Square Twisted Nails - Galvanised

- 30mm x 3.75mm
- 2.5kg box



Code	
<b>TN30375</b>	1

### Ring Shank Nails

- Annular Ringshanks
- Sherardised
- 25kg box
- Available in 50, 65 & 100mm lengths



Code		
<b>RSN50</b>	50mm	1
<b>RSN65</b>	65mm	1
<b>RSN100</b>	100mm	1

### Bright Panel Pins

- 5kg tub
- 30mm x 1.6mm



Code	
<b>BPP30</b>	1

### Rawl Plugs

- 100 pack
- RRP100, red, drill bit 5.5mm
- BRP100, brown, drill bit 7mm



Code	Qty.
RRP100	1
BRP100	1

### Drywall Screws Black PH2

- Price per box
- Complete with Phillips bit



Code	Size	Qty.
DWB3525	3.5x25mm	1,000
DWB3538	3.5x38mm	1,000
DWB3545	3.5x45mm	1,000
DWB4275	4.2x75mm	500

### Classic Wood Screws

- Single thread
- Pozi countersunk (PZD)
- Zinc & yellow
- Price per box

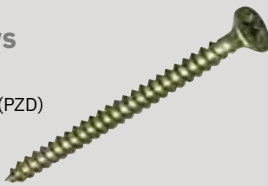

Code	Size	Qty.
WS420	4.0x20mm	200
WS425	4.0x25mm	200
WS430	4.0x30mm	200
WS440	4.0x40mm	200
WS450	4.0x50mm	200
WS460	4.0x60mm	200
WS470	4.0x70mm	200
WS530	5.0x30mm	200
WS540	5.0x40mm	200
WS550	5.0x50mm	200
WS560	5.0x60mm	200
WS570	5.0x70mm	200
WS580	5.0x80mm	200
WS590	5.0x90mm	200
WS5100	5.0x100mm	100
WS650	6.0x50mm	100
WS6100	6.0x100mm	100
WS6150	6.0x150mm	100

### Premium Wood Screws

- Improved countersinking & holding power
- Anti-friction thread reduces splitting
- Serrated thread for improved pull-out & torque when inserting
- Double cutting point for faster Drilling



Code	Size	Qty.
PWS420	4.0x20mm	200
PWS425	4.0x25mm	200
PWS430	4.0x30mm	200
PWS440	4.0x40mm	200
PWS450	4.0x50mm	200
PWS460	4.0x60mm	200
PWS470	4.0x70mm	200
PWS530	5.0x30mm	200
PWS550	5.0x50mm	200
PWS560	5.0x60mm	100
PWS570	5.0x70mm	100
PWS580	5.0x80mm	100
PWS590	5.0x90mm	100
PWS5100	5.0x100mm	100
PWS650	6.0x50mm	100
PWS6100	6.0x100mm	100
PWS6150	6.0x150mm	100

**SCREWDRIVER BITS & DRILL CHUCKS**

**Phillips Bits**

- Length 25mm
- Shank ¼" hexagon
- Titanium coated
- Shock & wear resistant
- S2 grade chrome vanadium steel



Code		
<b>FAISBPH1</b>	PH1	3
<b>FAISBPH2</b>	PH2	3
<b>FAISBPH3</b>	PH3	3

**Pozidrive Bits**

- Length 25mm
- Shank ¼" hexagon
- Titanium coated
- Shock & wear resistant
- S2 grade chrome vanadium steel
- Pack of 3



Code		
<b>FAISBPZ1</b>	PZ1	10
<b>FAISBPZ2</b>	PZ2	12
<b>FAISBPZ3</b>	PZ3	12

**Screwdriver Bit Set**

- Pozi: PZ1, PZ2
- Phillips: PH1, PH2
- Slotted: SL4.5, SL6.5
- Magnetic bit holder



Code		
<b>BD60480</b>		1

**Magnetic Bit Holders**

- ¼" 60mm length
- Chrome vanadium
- ¼" drive
- ¼" capacity



**BMBHSTD**



**BMBHQ5**

Code		
<b>BMBHSTD</b>	Hex	1
<b>BMBHQ5</b>	Quick release	1

### Magnetic Hex Sockets

- 8mm magnetic socket
- ¼ hex shank



Code

**MBHNUT8**



1

### Keyless Chucks

- Capacity 1.5 - 13mm
- x 20 mount keyless chuck
- Tungsten carbide jaw inserts
- Jaw locking system for hammer use



CHUCKSDS



CHUCK12K

Code

**CHUCK12K** ½" x 20

**CHUCKSDS** SDS



1

1

### Keyed Chuck

- 13mm capacity
- Rotary & impact drills
- For use with SDS & SDS Plus machines
- ½" x 20 UNF thread
- Complete with chuck key & adapter
- DIN6349



Code

**CHUCK12**



1

### Chuck Adaptor

- SDS chuck adaptor SDS to ½" UNF
- Allows drill chucks to be used with SDS & SDS Plus machines



Code

**CHUCKSDSA**



1

# CHEMICAL ANCHOR STUDS & ACCESSORIES

## Chemical Anchor Studs

- 5.8 grade Zinc plated steel
- Chisel point to prevent rod turning when tightening
- Complete with nut & washer
- With embedment depth mark

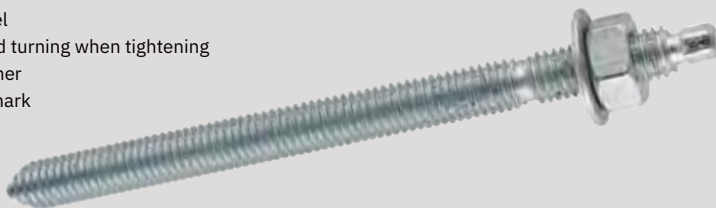

Code	Size	Max. fixing thickness	Recommended hole size req.	Box qty.	
<b>CASM8110</b>	M8 x 110mm	13mm	10 x 80mm	10	1
<b>CASM10130</b>	M10 x 130mm	20mm	12 x 90mm	10	1
<b>CASM12160</b>	M12 x 160mm	25mm	14 x 110mm	10	1
<b>CASM16190</b>	M16 x 190mm	35mm	18 x 125mm	10	1
<b>CASM20270</b>	M20 x 270mm	55mm	24 x 170mm	4	1

## Blow Out Pump Hole Cleaner

- Ideal for cleaning dust from drilled holes prior to applying bonded anchors or installing mechanical anchors
- Hole cleaning is necessary for correct loads
- Manual, easy to use
- Serial application

### Suitable for use in:

Cracked Concrete  
 Non Cracked Concrete  
 C20/25-C50/60  
 Aerated Concrete Block  
 Hollow or Solid Sand-lime Brick  
 Hollow Brick  
 Hollow Lightweight Concrete Block



Code	
<b>BOP01</b>	1

## FOR OUR FULL RANGE OF SDS DRILL BITS



SEE PAGES  
42-43

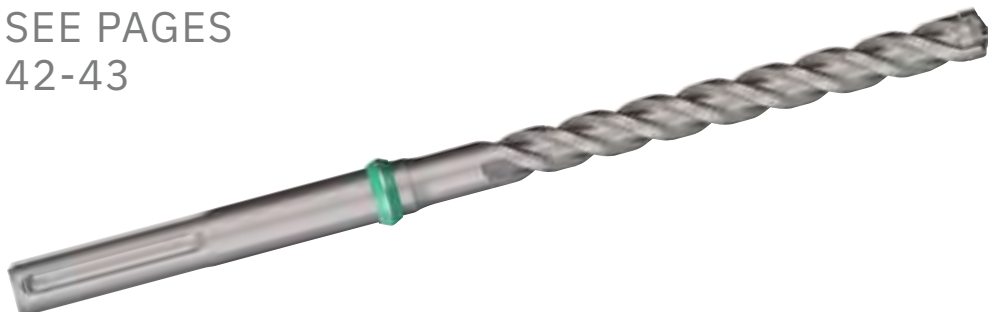

## Types & Features Of Resins Available

Types	Strength Performance Level	Cracked Concrete	Non Cracked	Indoor Use	Outdoor Use	Wet Application	Low Odour	Use With Rebar	Cure Speed	Suitable for use in all general masonry
<b>Pure Epoxy</b>	Extreme	✓	✓	✓	✓	✓	Solvent Free	✓	Slow	✓
<b>Vinylester</b>	High	✓	✓	✓	✓	✓	Styrene Free	✓	Fast	✓
<b>Epoxy Acrylate</b>	Medium	✗	✓	✓	✓	✓	Styrene Free	✓	Fast	✓
<b>Polyester</b>	Standard	✗	✓	✓	✓	✓	Styrene Free	✗	Fast	✓

### General Information:

- Cracked Concrete - Determined by structural engineer according to fixing application.
- Styrene Free - Low odour. More expensive. Better performance, higher strength. Friendly to environment. A+ Rating VOC content.
- Wet application - Curing time is twice as long and slightly lower performance. All performance testing is done in wet so stated figures are accurate for wet application. Performance in dry will be higher than stated figures.

## Product Approval Overview

Types	C2 Seismic	C1 Seismic	ETA Option 1	ETA Option 7 Non- Cracked	TR023 Post Installed Rebar	Diamond Drilled Holes	Fire Rated	WRAS	Strength	Cure Temp. Range
<b>PUR500585</b> Resin 585ml	✓	✓	✓	✓	✓	✓	✓	✓	*****	5 - 45 deg
<b>MAXCR04</b> Resin 410ml	✗	✗	✓	✓	✓	✗	✓	✓	*****	-10 to 35 deg
<b>MAXCR03</b> Resin 410ml	✗	✗	✗	✓	✓	✗	✓	✓	*****	-10 to 35 deg
<b>MAXCR02</b> Resin 300ml	✗	✗	✗	✓	✗	✗	✗	✗	*****	-10 to 35 deg
<b>MAXCR01</b> Resin 410ml	✗	✗	✗	✓	✗	✗	✗	✗	*****	-10 to 35 deg

## Installation Guide



## Standard Hole Dimensions In Concrete

Threaded Rod Diameter	M8	M10	M12	M16	M20	M24	M30
<b>Hole Diameter (mm)</b>	10	12	14	18	24	28	35
<b>Hole Embedment Depth (mm)</b>	80	90	110	125	170	210	280
<b>Est No. of holes per 410ml</b>	85	52	31	16	7	4	2

Rebar Distance (mm)	8	10	12	14	16	18	20	22	25	28	32
<b>Hole Diameter (mm)</b>	12	14	16	18	20	22	25	28	32	35	38
<b>Hole Embedment Depth (mm)</b>	110	120	130	140	150	160	170	190	210	280	320
<b>Est No. of holes per 410ml Cartridge</b>	42	28	20	14	11	8	6	4	3.1	1.9	1.4

# CHEMICAL ANCHOR RESINS

## PUR500585 - PUR Epoxy Solvent Free Chemical Anchor Resin 585ml

### Product Description

PUR 500 is a 2 component high strength pure epoxy chemical anchoring resin system. It is designed for deep embedment and large diameter holes due to its zero shrinkage, and longer working times. For diamond drilled holes, with rebar, and in areas of high chemical exposure eg. Seasalt and swimming pools.

Use MET585 for correct applicator

### Features & Benefits

- High bond strength with High load resistance
- Used with all grades of threaded rod and rebar in accordance with TR029
- Ideal for deep embedment installations
- Used in non-cracked and cracked concrete
- Used in dry and wet concrete and also in wood
- Used in flooded holes
- Used for overhead applications
- ETA approved for diamond drilled holes
- Ideal for elevated temperatures - temperature ranges I, II and III
- ETA approved for rebar installations under TR023 and EN1992-1-1:2004 EC2
- Zero shrinkage enables large diameter installations
- **ETA approved for Seismic Loads C2**
- Manual cleaning up to 20mm diameter and embedment depths of 240mm
- Independently tested and approved - anchor life 50 years
- 24 Month shelf life
- A+ Rating VOC content

### Approvals

- ETA Option 1 ETAG 001 for cracked concrete with studs and rebar TR029
- ETA Option 1 ETAG 001 for rebar TR023 : Approved for Seismic Loads C2
- F120 Fire Test report • ICC-ES Approval ESR 3853
- BS6920 for use with potable water WRAS Approved 1309522
- ETA approved in flooded holes, wet and dry concrete
- Tested according to LEED 2009 EQ c4.1, SCAQMD rule 1168 (2005)



MET585



### Minimum Curing Time

Concrete Temperature	Gel - Working Time	Minimum Curing Time In Dry Concrete	Minimum Curing Time In Wet Concrete
<b>5 C</b>	120 minutes	3000 minutes	x2
<b>15 C</b>	60 minutes	1200 minutes	x2
<b>25 C</b>	25 minutes	480 minutes	x2
<b>35 C</b>	16 minutes	240 minutes	x2
<b>40 C</b>	10 minutes	150 minutes	x2

### Code

<b>PUR500585</b>	585ml	12
<b>MET585</b>	585ml extrusion tool	12
<b>RNOZZLE</b>	Applicator nozzle	12



**MAXCR04 - MAX Vinylester Styrene Free Chemical Anchor Resin 410ml**



**Product Description**

MAX Vinylester is a 2 component high strength 10:1 ratio chemical anchoring resin system. It is designed as a fast curing high strength resin fixing anchor for very high loads and critical and overhead fixings especially in corrosive environments, or damp conditions.

Use MET410 for correct applicator.

**Features & Benefits**

- High bond strength with High load resistance
- Used with all grades of threaded rod and rebar in accordance with TR029
- Used in non-cracked and cracked concrete
- Fast gelling and curing
- Used in dry and wet concrete
- Used in critical or overhead applications
- Used in corrosive environments
- ETA tested based on life of anchor 50 years
- Used for elevated temperatures - temperature ranges I, II and III
- Used for post installed rebar installations under TR029 and TR023
- Low shrinkage enables large diameter installations
- Close edge distance and small spacing
- Manual cleaning up to 20mm diameter and embedment depths of 240mm
- Independently tested and approved

**Approvals**

- ETA Option 7 ETAG 001 for uncracked concrete with studs and rebar TR029
- ETA Option 1 ETAG 001 for cracked concrete with studs
- ETA for post installed Rebar TR023
- Fire approved R180
- Tested to BS6920 for use with potable water
- Tested according to LEED 2009 EQ c4.1, SCAQMD rule 1168 (2005).



MET410



**Minimum Curing Time**

Concrete Temperature	Gel - Working Time	Minimum Curing Time In Dry Concrete	Minimum Curing Time In Wet Concrete
<b>-10 C *</b>	50 minutes	240 minutes	x2
<b>-5 C *</b>	40 minutes	180 minutes	x2
<b>5 C</b>	20 minutes	90 minutes	x2
<b>15 C</b>	9 minutes	60 minutes	x2
<b>25 C</b>	5 minutes	30 minutes	x2
<b>35 C</b>	3 minutes	20 minutes	x2

**Code**

<b>MAXCR04</b>	410ml	12
<b>MET410</b>	410ml applicator	12
<b>RS410G</b>	410ml applicator	12
<b>RNOZZLE</b>	Applicator nozzle	12

# CHEMICAL ANCHOR RESINS

## MAXCR03 - MAX Epoxy Acrylate Styrene Free Chemical Anchor Resin 410ml



### Product Description

MAX Epoxy Acrylate is a 2 component high strength 10:1 ratio chemical anchoring resin system. It is designed as a fast curing high strength resin fixing anchor for high loads and medium loads and is particularly advantageous for fixings in damp environments or with chemical exposure.

Use MET410 for correct applicator.

### Features & Benefits

- High bond strength with High load resistance
- Used with all grades of threaded rod and rebar
- Used in concrete and masonry
- Fast gelling and curing
- Used in dry/wet concrete and flooded holes
- Resistance to chemicals and damp conditions
- Close edge distance and small spacing
- European approval for use in masonry with nylon sleeves
- Economical fixing resin
- Extremely versatile
- Styrene free with low odour
- Manual cleaning up to 20mm diameter and embedment depths of 240mm
- Independently tested and approved

### Approvals

- 18/0800 - ETA EAD 330499-00-0601 M8-M24 Threaded Rods 8-25mm Rebar
- 18/0799 - ETA EAD 330076-00-0804 M6-M12 Masonry Installations.
- CE Certified 1404-CPR-3054/3053 - ZAG, Slovenia.
- Tested according to LEED 2009 EQ c4.1, SCAQMD rule 1168 (2005).
- WRAS Approved for use with Potable drinking water no. TBA.
- A+ Rating VOC content



### Minimum Curing Time

Concrete Temperature	Gel - Working Time	Minimum Curing Time In Dry Concrete	Minimum Curing Time In Wet Concrete
<b>-10 C *</b>	50 minutes	240 minutes	x2
<b>-5 C *</b>	40 minutes	180 minutes	x2
<b>5 C</b>	20 minutes	90 minutes	x2
<b>15 C</b>	9 minutes	60 minutes	x2
<b>25 C</b>	5 minutes	30 minutes	x2
<b>35 C</b>	3 minutes	20 minutes	x2

### Code

<b>MAXCR03</b>	410ml
<b>RNOZZLE</b>	Applicator nozzle



12

12

**MAXCR02 - MAX Polyester Styrene Free Chemical Anchor Resin 300ml**

**MAXCR01 - MAX Polyester Styrene Free Chemical Anchor Resin 410ml**



**Product Description**

MAX Polyester a 2 component high strength 10:1 ratio chemical anchoring resin system. It is designed as a fast curing high strength resin fixing anchor for high loads and medium loads and is particularly advantageous for fixings in masonry due to the European approval and gives excellent value for money. Use MET410 or RS300G for correct applicator.

**Features & Benefits**

- Good bond strength with High load resistance
- Used with all grades of threaded rod
- Used in concrete and masonry
- Fast gelling and curing
- Used in dry and wet conditions
- European approval for use in concrete ETAG001 Option 7
- European approval for use in masonry with nylon sleeves
- Close edge distance and small spacing
- Also suitable as a filler for gap and crack filling
- Economical fixing resin
- Extremely versatile
- Styrene free with low odour
- Close edge distance and small spacing
- Manual cleaning up to 20mm diameter and embedment depths of 240mm
- Independently tested and approved

**Approvals**

- ETA ETAG 001 Option 7 M8-M16
- ETA ETAG 029 for Masonry Size M10
- ITB approved AT-15-6900:2011 - ITB-978/W
- Association Socotec Approval CAZ 0834/1
- Tested according to LEED 2009 EQ c4.1, SCAQMD rule 1168 (2005).
- A+ Rating VOC content



**Minimum Curing Time**

Concrete Temperature	Gel - Working Time	Minimum Curing Time In Dry Concrete	Minimum Curing Time In Wet Concrete
<b>-10 C *</b>	50 minutes	240 minutes	x 2
<b>-5 C *</b>	40 minutes	180 minutes	x 2
<b>5 C</b>	20 minutes	90 minutes	x 2
<b>15 C</b>	9 minutes	60 minutes	x 2
<b>25 C</b>	5 minutes	30 minutes	x 2
<b>35 C</b>	3 minutes	20 minutes	x 2

Code		📦
<b>MAXCR02</b>	300ml	12
<b>MAXCR01</b>	410ml	12
<b>MET300</b>	300ml tool	12
<b>MET410</b>	410ml applicator	12
<b>RS410G</b>	410ml applicator	12
<b>RSNOZZLE</b>	Applicator nozzle	12

## MASONRY & STEEL FIXINGS

### Nylon Hammer In Fixings

- Nylon hammer fixings are for quick & easy fixing into concrete & solid masonry
- Zinc & Yellow passivated



Code	Size	Qty.	
<b>NHF660</b>	M6x60mm	100	1
<b>NHF880</b>	M8x80mm	100	1
<b>NHF8120</b>	M8x120mm	50	1

### Construction Screws Self Drilling Hex Head - Steel (Light)

- Self-drilling screws for light section 5mm steel to steel with a coarse self-tapping thread
- HEX head self-drill screw with 16mm washer

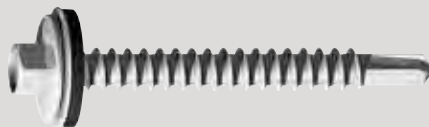

Code	Size	Qty.	
<b>CSSL5525</b>	5.5x25mm	100	1
<b>CSSL5538</b>	5.5x38mm	100	1
<b>CSSL5548</b>	5.5x48mm	100	1
<b>CSSL5550</b>	5.5x50mm	100	1
<b>CSSL5551</b>	5.5x51mm	100	1

### Construction Screws Self Drilling Hex Head - Steel (Thick)

- Self-drilling screws for heavy section 12mm steel to steel
- HEX head self-drill screw with 16mm washer



Code	Size	Qty.	
<b>CSSH5532</b>	5.5x32mm	100	1
<b>CSSH5538</b>	5.5x38mm	100	1
<b>CSSH5560</b>	5.5x60mm	100	1
<b>CSSH5580</b>	5.5x80mm	100	1

### Construction Screws Self Drilling - Timber (Light)

- Phillips recess wing tip self-drilling screws for light section steel. They have a coarse self-tapping thread & 6 ribs on the head to assist completion of countersinking
- Self-drilling screws for light section timber to steel up to 4mm thick



Code	Size	Qty.	
<b>CSTL5540</b>	5.5x40mm	200	1
<b>CSTL5560</b>	5.5x60mm	200	1
<b>CSTL5580</b>	5.5x80mm	100	1
<b>CSTL55100</b>	5.5x100mm	100	1

### Construction Screws Self Drilling - Timber (Thick)

- Self-drilling screws for heavy section timber to steel up to 12mm thick
- Phillips recess



Code	Size	Qty.	
<b>CSTH5560</b>	5.5x60mm	200	1
<b>CSTH5585</b>	5.5x85mm	100	1
<b>CSTH55100</b>	5.5x109mm	100	1

### Multi-Fix Concrete Frame Screws

- Countersunk
- Torx TX30



Code	Size	Qty.	
<b>MCS75/50</b>	M7.5x50mm	100	1
<b>MCS75/60</b>	M7.5x60mm	100	1
<b>MCS75/80</b>	M7.5x80mm	100	1
<b>MCS75/100</b>	M7.5x100mm	100	1
<b>MCS75/120</b>	M7.5x120mm	100	1
<b>MCS75/150</b>	M7.5x150mm	100	1
<b>MCS75/180</b>	M7.5x180mm	100	1

## SLEEVE & WEDGE ANCHORS

### Setting Punch for Wedge Anchor

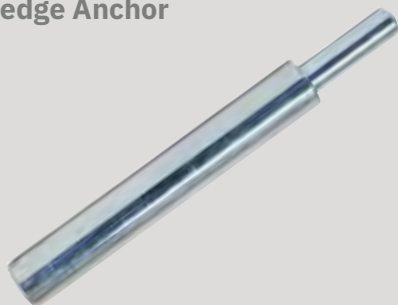

Code	Size	Qty.
<b>DZSP08</b>	M8 setting punch	1
<b>DZSP10</b>	M10 setting punch	1
<b>DZSP12</b>	M12 setting punch	1

### Drop in Wedge Anchors Standard - Non Lipped

- An internally threaded socket anchor for use with bolts or threaded rod of any length. May be set flush or at a depth
- Full expansion can be guaranteed by using the correct shouldered setting punch.
- Suitable for use in concrete



Code	Size	Qty.
<b>DWA830</b>	M8 x 30mm	100
<b>DWA1040</b>	M10 x 40mm	100
<b>DWA1260</b>	M12 x 50mm	50
<b>DWA1665</b>	M16 x 65mm	25

### Through Bolts Zinc Plated & Yellow Passivated

- The through bolt is the ultimate "through fixing" with the hole diameter as the bolt diameter. It is ideal for bolting in place awkward fixtures without the need for marking out, removal or repositioning
- It is a torque controlled anchor suitable for use in concrete over C20/25 strength



Code	Size	Qty.
<b>TB10100</b>	M10 x 100mm	50
<b>TB10120</b>	M10 x 120mm	50
<b>TB12100</b>	M12 x 100mm	20
<b>TB12120</b>	M12 x 120mm	20

### Sleeve Anchors Hex Bolt Zinc Plated and Yellow Passivated

- The Hex Nut sleeve anchor is a thin walled sleeve anchor suitable for use in concrete, stone, brickwork, perforated bricks & dense concrete blocks
- The diagonal slot enables the small gaps to be pulled down & a positive clamping force to be exerted through the fixture



Code	Size	Qty.
<b>SLB10055</b>	M10 x 55mm	50
<b>SLB10100</b>	M10 x 100mm	50
<b>SLB12100</b>	M12 x 100mm	50
<b>SLB12125</b>	M12 x 125mm	25

### Hi-Tensile Sockets

- For use with concrete screw anchors



Code	Size	Qty.
<b>HSKT13</b>	13mm ½" drive	1
<b>HSKT16</b>	16mm ½" drive	1
<b>HSKT17</b>	17mm ½" drive	1
<b>HSKT19</b>	19mm ½" drive	1
<b>HSKT21</b>	21mm ½" drive	1
<b>HSKT24</b>	24mm ½" drive	1
<b>HSKT27</b>	27mm ½" drive	1

## MULTI FIXING BOLTS & THREADED BARS

### Hex Head Concrete Anchor Bolts

- Heavy duty anchoring into concrete, brick, stone, wood & concrete blocks
- High low parallel threads for ease of insertion & high pull out values
- B point for use in pre-drilled shallow holes



Code	Size	Box qty.	
<b>M0860</b>	M8 x 60mm	100	1
<b>M0875</b>	M8 x 75mm	100	1
<b>M08100</b>	M8 x 100mm	100	1
<b>M1075</b>	M10 x 75mm	100	1
<b>M10100</b>	M10 x 100mm	100	1
<b>M12100</b>	M12 x 100mm	50	1
<b>M12150</b>	M12 x 150mm	25	1
<b>M14100</b>	M14 x 100mm	50	1
<b>M16100</b>	M16 x 100mm	25	1
<b>M16150</b>	M16 x 150mm	10	1

### Threaded Bar

- Grade 4.8g zinc threaded bar
- 2m lengths
- 8, 10 & 12mm diameters
- Can be used with chemical resin

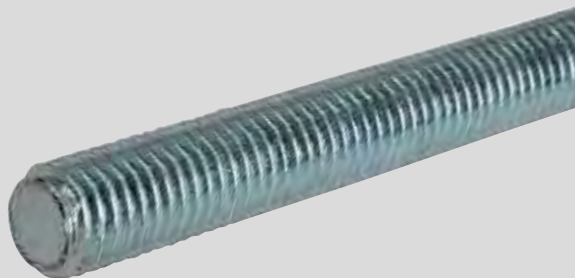

Code	Size	Sold per	
<b>M82NTRTR</b>	M8 x 2m	each	25
<b>M102NTRTR</b>	M10 x 2m	each	15
<b>M122NTRTR</b>	M12 x 2m	each	10

### Zinc Connector Nuts

- For extending the length of threaded bar
- Conforms to DIN6334

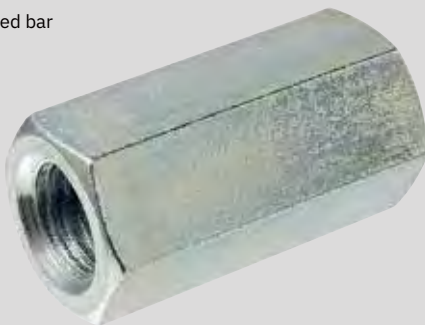

Code	Size	Pack size	
<b>M10TBCN100</b>	M10 x 30mm	100	1

## Hexagon Set Screws Fully Threaded BZP

- Grade 8.8  
Din 933
- Bright zinc



Code	Size	Box qty.	
HSF0650	M6 x 50mm	200	1
HSF0820	M8 x 20mm	200	1
HSF0850	M8 x 50mm	200	1
HSF0890	M8 x 90mm	100	1
HSF1025	M10 x 25mm	200	1
HSF1040	M10 x 40mm	100	1
HSF1050	M10 x 50mm	100	1
HSF1080	M10 x 80mm	50	1
HSF1090	M10 x 90mm	50	1
HSF10100	M10 x 100mm	50	1
HSF10150	M10 x 150mm	50	1
HSF1230	M12 x 30mm	100	1
HSF1240	M12 x 40mm	100	1
HSF1250	M12 x 50mm	50	1
HSF1255	M12 x 55mm	50	1
HSF1265	M12 x 65mm	50	1
HSF1280	M12 x 80mm	50	1
HSF1290	M12 x 90mm	50	1
HSF12100	M12 x 100mm	50	1
HSF12150	M12 x 150mm	25	1
HSF1630	M16 x 30mm	50	1
HSF1635	M16 x 35mm	50	1
HSF1640	M16 x 40mm	50	1
HSF1650	M16 x 50mm	50	1
HSF1660	M16 x 60mm	25	1
HSF1670	M16 x 70mm	25	1
HSF1690	M16 x 90mm	25	1
HSF16100	M16 x 100mm	25	1
HSF16120	M16 x 120mm	25	1
HSF16150	M16 x 150mm	25	1
HSF2030	M20 x 30mm	25	1
HSF2040	M20 x 40mm	25	1
HSF2050	M20 x 50mm	25	1
HSF2080	M20 x 80mm	20	1
HSF20100	M20 x 100mm	20	1
HSF20150	M20 x 150mm	10	1

## Hexagon Bolt Part Thread Bright Zinc Plated

- Grade 8.8  
Din 931
- Bright zinc



Code	Size	Box qty.	
HPF1050	M10 x 50mm	100	1
HPF1080	M10 x 80mm	50	1
HPF10100	M10 x 100mm	50	1
HPF10120	M10 x 120mm	50	1
HPF10150	M10 x 150mm	50	1
HPF10180	M10 x 180mm	25	1
HPF10220	M10 x 220mm	25	1
HPF1250	M12 x 50mm	100	1
HPF1280	M12 x 80mm	50	1
HPF12100	M12 x 100mm	50	1
HPF12120	M12 x 120mm	50	1
HPF12140	M12 x 140mm	25	1
HPF12150	M12 x 150mm	25	1
HPF12180	M12 x 180mm	25	1
HPF12220	M12 x 220mm	25	1
HPF1650	M16 x 50mm	25	1
HPF1680	M16 x 80mm	25	1
HPF16100	M16 x 100mm	25	1
HPF16120	M16 x 120mm	25	1
HPF16140	M16 x 140mm	10	1
HPF16150	M16 x 150mm	20	1
HPF16180	M16 x 180mm	10	1
HPF16220	M16 x 220mm	10	1
HPF2050	M20 x 50mm	25	1
HPF2080	M20 x 80mm	20	1
HPF20100	M20 x 100mm	10	1
HPF20150	M20 x 150mm	10	1

## NUTS &amp; WASHERS

Square Plate Washers BZP  
-Bright Zinc Plated

- Square plate washer
- Zinc & clear
- Round hole
- BS3410



Code	Size	Qty.	
<b>SPW1040</b>	M10 x 40 x 3mm	100	1
<b>SPW1050</b>	M10 x 50 x 3mm	100	1
<b>SPW1240</b>	M12 x 40 x 3mm	100	1
<b>SPW1250</b>	M12 x 50 x 3mm	100	1
<b>SPW1650</b>	M16 x 50 x 3mm	100	1

Steel Flat Washer  
Form A BZP

- Bright plain washer
- Form A zinc & clear
- BS432



Code	Size	Qty.	
<b>FWM06</b>	M6	100	1
<b>FWM08</b>	M8	100	1
<b>FWM10</b>	M10	100	1
<b>FWM12</b>	M12	100	1
<b>FWM16</b>	M16	100	1
<b>FWM20</b>	M20	100	1
<b>FWM24</b>	M24	100	1

Hexagon Full Nuts  
Bright Zinc Plated

- Zinc plated
- DIN934



Code	Size	Qty.	
<b>HFN06</b>	M6	200	1
<b>HFN08</b>	M8	200	1
<b>HFN10</b>	M10	100	1
<b>HFN12</b>	M12	100	1
<b>HFN16</b>	M16	100	1
<b>HFN20</b>	M20	50	1
<b>HFN24</b>	M24	25	1



**Butt Hinges  
- Zinc Plated**

- Pack of 2



Code	Size	
<b>BHZP75</b>	75mm (3")	6
<b>BHZP100</b>	100mm (4")	6

**T Hinges  
- Black Japanned**

- Pack of 2



Code	Size	
<b>TH150B</b>	150mm (6")	1
<b>TH300B</b>	300mm (12")	1
<b>TH400B</b>	400mm (16")	1

**Hasp & Staple  
- Zinc Plated**

- 150mm
- Staple hole size: 12mm
- Fixings not included

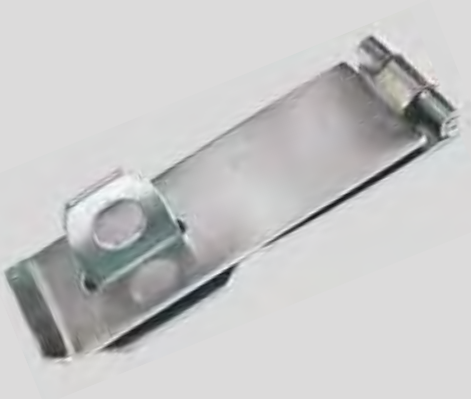

Code	
<b>FAIPHS150</b>	1

**Padlock Bolt**

- Bright zinc plated brenton padbolt
- 200mm (8")



Code	
<b>PADB200</b>	1

SITE IRONMONGERY

Digital Keypad Lock

- Satin chrome



Code

DIGKEY



10

Brass Padlock

- Brass body
- Hardened steel shackle
- Complete with 2 keys



Code



PDLB30	30mm	6
PDLB40	40mm	6
PDLB50	50mm	6
PDLB60	60mm	6

FOR OUR FULL RANGE OF PADLOCKS



SEE PAGES 156-157



# CONCRETE & FORMWORK ACCESSORIES



Concrete Testing	402-403
Rakes	404
Concrete Placers & Brooms	405
Curing Tank, Frost Protection & Thermometers	406
Tying Wire, Cutters & Denso Tape	407
Chemicals & Sealants	408
Formwork Oil Sprayers	409
Rebar Safety Strip & Mushroom Caps	410

CONCRETE TESTING

Metal Test Cube Moulds

• BS 1881



TCMS4



TCMS6

Code		
TCMS4	100mm	1
TCMS6	150mm	1

Plastic Test Cube Moulds

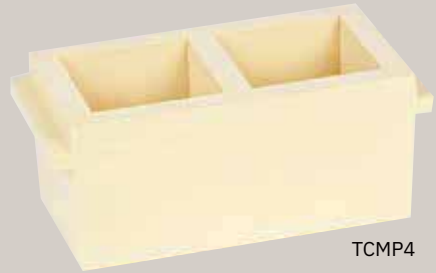

TCMP4



TCMP6

Code		
TCMP4	100mm (2-gang)	1
TCMP6	150mm	1

Polystyrene Test Cube Moulds

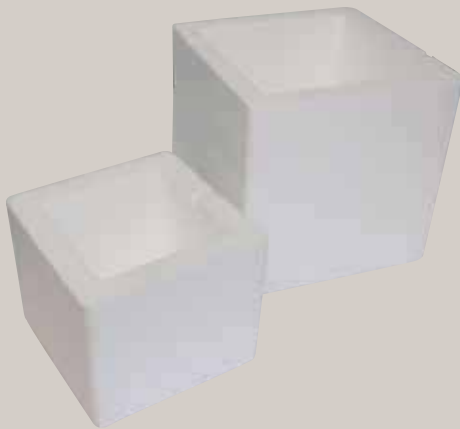

Code		
TCMPT4	100mm	1
TCMPT6	150mm	1

2 Part Metal Test Cube Mould



Code		
TCMS4-2PART	100mm	1
TCMS6-2PART		1

**Test Cube  
Tamping Bar**



Code  **CNTCTB** 1

**Tamping Rod  
for Slump**



Code  **CNTRSC** 1

**Aluminium Concrete  
Scoop**



Code  **CNTSC** 10

**Concrete  
Slump Cone**



Code  **CNSC** 100mm cone 1  
**CN012** Cone base 1  
**CN010** BS slump cone 1

**Indent  
Roller**

• 250 x 100mm

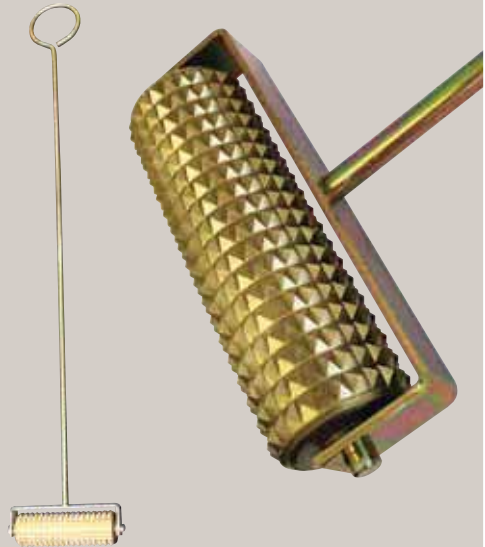

Code  **CNINR** 10

RAKES

Round Tooth  
Tarmac Rake

- 48" hardwood plain handle
- Head size 16 x 4"
- 16 tooth



Code

RKTRTW



5

Round Tooth  
Tarmac Rake

- 66" tubular steel handle
- Head size 16 x 4"
- 16 tooth



Code

RKTRTS



5

Square Tooth  
Asphalt Rake

- 66" tubular steel handle
- Head size 16 x 4"
- 16 tooth

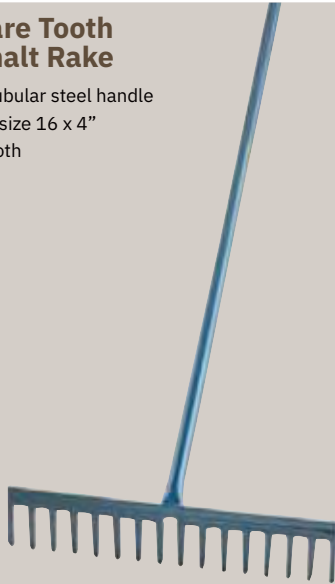

Code

RKASTS



5

Square Tooth  
Asphalt Rake

- 48" hardwood plain handle
- Head size 16 x 4"
- 16 tooth



Code

RKASTW



5

### Heavy Duty Concrete Placer

- 60" hardwood handle
- Blade size 20 x 4"
- Double dipped interchangeable aluminium blade

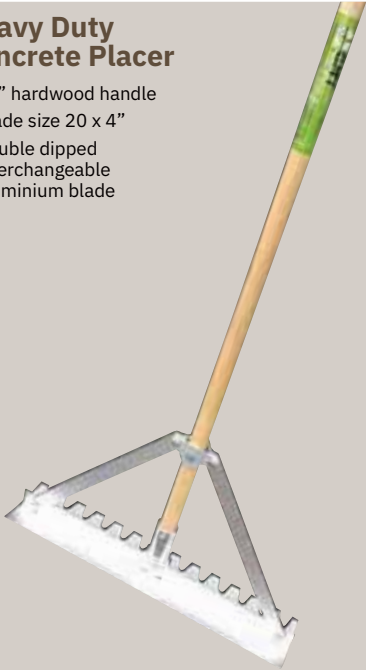

Code

CA160



5

### Aluminium Spazzle

- 60" hardwood handle
- Blade size 24 x 4"
- Aluminium blade



Code

CA150



5

### Concrete Finishing Broom c/w Handle & Stay



Code

BRCON450 450mm (18")

BRCON600 600mm (24")

BRCON900 900mm (36")

BRCON1200 1200mm (48")



5

5

5

5

### Big Blue Float Kit c/w Knuckle Head & 3 Handles

- Width 1200mm (48")
- Depth 300mm
- Weight 11kg
- Curved blade prevents marks in the work surface

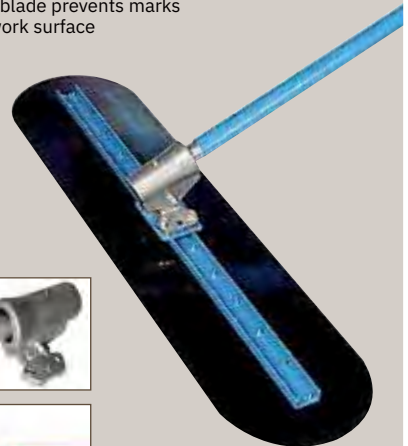

Code

CA1200E



1

**CURING TANK, FROST PROTECTION & THERMOMETERS**

**Polypropylene Concrete Curing Tanks**

- 700 x 540 x 530mm
- Accepts 12 x 150mm or 40 x 100mm cubes
- Includes thermostat



Code		
<b>CT110V</b>	110v	1
<b>CT240V</b>	240v	1

**Frost Protection Foam Blanket**

- 8mm x 1.5m x 75m

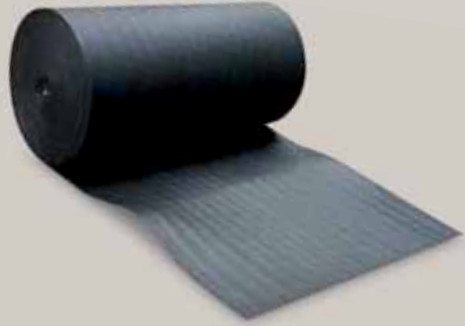

Code		
<b>FROST05</b>		1

**Digital Thermometer**

- Celsius & Fahrenheit
- -50°C to +125°C (-58F to +257F)
- Easy read screen
- Includes battery



Code		
<b>THDIGI</b>		1

**Thermometer Max-Min Standard**

- -40°C to +50°C



Code		
<b>TH100</b>		1

**Concrete Brass Probe Thermometer**

- -35°C to +50°C



Code		
<b>THC200</b>		1



**Stainless Steel Tying Wire**

- 18 gauge
- 20kg coil



Code 1  
**TYWBS**

**Black Annealed Tying Wire**

- 16 gauge
- 12kg coil



Code 1  
**TYWBA**

**Professional End Cutters**

- Made in the same factory as Knippex



Code 6  
**NCPEC200**

**Denso Tape**

- 10m length



Code	Width	
<b>DENSO50</b>	50mm	24
<b>DENSO75</b>	75mm	16
<b>DENSO100</b>	100mm	12
<b>DENSO150</b>	150mm	8

**CHEMICALS & SEALANTS**

**Mould Oil**

- Provides a physical barrier & chemical release
- Application: spray, brush or mop
- Kerosene based



Code		
<b>CRA05L</b>	5 litre	4
<b>CRA25L</b>	25 litre	40
<b>CRA200L</b>	200 litre	40

**Ecotard MF Mould & Form Face Retarder**

- Colour tinted to assist application
- Application: roller or brush



Code		
<b>CATARDMF25</b>	25 litre	40

**Concrete Curing Compound**

- 25 litre
- An economical water based silicate general purpose curing compound
- Red tinted
- Application: Help curing process in concrete



Code	
<b>WBCA25</b>	40

**Ecolase Form Release Agent**

- 25 litre
- Water based
- For use in environmentally sensitive applications
- Application: spray



Code	
<b>FRA25</b>	40

**Ecotard TF Top Face Retarder**

- 25 litre
- Spray applied
- Slows the set of surface mortar
- Application: spray



Code	
<b>CATARDTF25</b>	40

### MAX Professional Sprayer

- Filling contents: 5 litre
- Total contents: 7 litre
- Operating pressure: 3 bar (44psi)
- Weight when empty: 1.7kg
- Tank: Plastic with large pressure reservoir
- Carried at the side
- Seals: FPM
- Nozzle: Flat-jet plastic nozzle
- Spray wand: Plastic, 50cm, 360° rotatable
- Hose: 2m, transparent, oil resistant
- Viton seals for chemical resistance



Code

CONSPRAY5



### Professional Formwork Oil Sprayer

- 5 litre capacity
- Pressure gauge & safety valve
- 6 bar (90psi)
- Metal tank



Code

WS500P



REBAR SAFETY STRIP & MUSHROOM CAPS

Rebar Safety Strip

- Reuseable
- Weather resistant
- Plastic or steel reinforced
- 1m length strips



SPS100



SPP100

Code



<b>SPP100</b>	Plastic (visual aid only)	10
<b>SPS100</b>	Steel (anti-impalement)	6

Mushroom Caps

- Small 6 - 16mm
- Large 16 - 32mm
- Pack of 250



MUSHS

MUSHL

Code



<b>MUSHS</b>	Small	40
<b>MUSHL</b>	Large	40

OTHER CONCRETE ACCESSORIES ARE AVAILABLE

- Concrete square bar
- Continuous plastic chair
- Plastic spacers
- Concrete spacers
- Tierod bar
- Dowel bar



CONTACT US WITH YOUR REQUIREMENTS

# PLANT, POWER TOOLS & AUTOMOTIVE



Drills, Batteries & Chargers	414
Saws & Grinders	415
Pressure Washers & Dust Extractor	416
Submersible Pumps	418
Wet Concrete Equipment	419
Hand Tampers & Breaker Steels	420
Compaction Equipment	421-422
Floor Saws	423
Cut-Off Saws	424-425
Trailer Parts	426-427
Automotive Supplies	428-429
Automotive Maintenance & Cleaning	430

# ONE BATTERY PLAYS OVER 170 SOLUTIONS

Makita 18V Li-ion  
batteries charge  
in under an hour



**22**  
minute  
charge



**36**  
minute  
charge



**45**  
minute  
charge



**55**  
minute  
charge



**18v + 18v**

# PLATFORM TOOLS

CONTACT  
CMT FOR  
SPECIAL  
DEALS  
020 8311 1144



36v

**18v**  
LITHIUM-ION

3.0Ah Li-ion 4.0Ah Li-ion 5.0Ah Li-ion 6.0Ah Li-ion

**BL**  
MOTOR

Visit our website for more information [www.makitauk.com](http://www.makitauk.com)

## DRILLS, BATTERIES & CHARGERS

### Makita Combi Drill & Impact Driver Kit

- Includes: case, charger, Combi drill, impact driver & 3 x 18v Li-ion batteries



Code

**MAKCOMBOJX1**



1

### Makita Li-ion Rapid Battery Charger

- Suits 3.0Ah, 4.0Ah & 5.0Ah Li-on batteries
- 14.4v - 18v
- Air cooled rapid charge technology



Code

**MAKFC18**



1

### Makita Lithium Li-ion Batteries

- Lightweight & shock absorbing
- Li-ion offers 430% more capacity than traditional Ni-Cad
- Remains cool even in heavy use



Code

**MAKBAT3AH** 3.0Ah

1

**MAKBAT4AH** 4.0Ah

1

### Makita DDF453Z 18v LXT Drill Driver

- 18v Combi drill
- Single sleeve keyless chuck
- Compatible with Li-ion battery
- Body only



Code

**MAKDDB3**



1

### Makita 110v SDS Plus Drill

- AVT anti-vibration technology
- 850 Watt
- 5 Joule impact energy

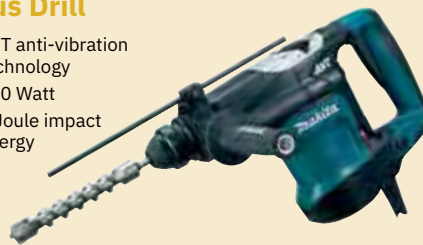

Code

**MAKSDSP210C**



1

### Makita DTD152Z 18V LXT Impact Driver

- Compact design impact driver
- Twin LED lights
- Compatible with Li-ion battery
- Body only



Code

**MAKDTD152Z**



1

### Makita SDS Max Rotary Hammer Drill 110v

- AVT anti-vibration technology
- 850 Watt
- 9.4 Joule impact energy



Code

**MAKSDSM511C**



1



### Makita 5903R Circular Saw 235mm - 110v

- Powerful motor
- Dust extraction facility
- Quick release height adjustment
- Suits our MAXTCT-235 range of blades. See page 38



Code

MAK5903R



1

### Makita Dustbag To Suit 5903R Circular Saw

- Cleaner finish & less dust
- Cloth bag for efficient collection



Code

MAKDUSTB903



1

### Makita Reciprocating Saw - 110v

- Variable speed control
- Double insulation
- Tool-less blade change



Code

MAKRECI110V



1

### Makita Orbital Action Jigsaw - 110v

- Quick release tool-less blade change
- Variable electronic speed control
- Sturdy adjustable base for accurate cutting



Code

MAK4350CT-110V



1

### Makita 115mm Angle Grinder - 110v

- Small gear housing for easy handling & manoeuvrability
- Anti-restart function
- Machine bevel gears
- Powerful 720W motor with excellent heat-resistance
- Soft start feature
- Ergonomic 20 degree side grip angle
- Lock-on switch to reduce user fatigue



Code

MAKAG115-110V



1

### Makita 230mm Angle Grinder - 110v

- Compact & lightweight design
- Large trigger switch
- Small gear housing for easy handling & manoeuvrability
- Double insulation



Code

MAKAG230-115



1

**PRESSURE WASHERS & DUST EXTRACTOR**

**MAX High Pressure Washer 165 Bar 240v**

- 165 bar max. pressure
- 2.1kW 240v motor
- 468 litres per hour max. flow rate
- 5m hose length on integrated reel with hose & lance storage
- Built in detergent tank
- Auto stop/start
- Fully adjustable spray nozzle



Code  
MAXPW165



1

**Kärcher Compact Pressure Washer 130 Bar - 240v**

- 420 litres per hour flow rate
- 6m hose length
- Weight: 11.4kg
- 1800 Watt motor



Code  
KARK4



1

**Kärcher Compact Pressure Washer 110 Bar - 240v**

- 360 litres per hour flow rate
- 4m hose length
- Weight: 4kg
- 1400 Watt motor



Code  
KARK2C



1

**M-Class Wet & Dry Dust Extractor 110v**

- 42 litre tank capacity
- Includes hose, adapters, fleece filter bag & disposal bag
- Weight: 16kg
- 1200 Watt motor



Code  
VC4210MX



1



#PERFORMANCE  
#DURABILITY  
#SAFETY



**OTEC**<sup>TM</sup>  
a cut above the rest

## SUBMERSIBLE PUMPS

### Submersible Pumps

For use in civil engineering, construction, landscaping, utilities and flooding emergency applications.

In these environments you need a pump that can handle the unknown subsurface conditions of mud, sludge, sand and other debris without breaking down.

#### SUBPMP1

- Robust & compact contractor pump
- 50mm (2") outlet
- Tough steel base & body

#### SUBPMP2

- Puddle sucker pump able to pump water down to 1m
- 25mm (1") outlet
- Tough steel base & body



SUBPMP1



SUBPMP2

#### Code

<b>SUBPMP1</b>	Submersible abrasive water pump	1
<b>SUBPMP2</b>	Puddle sucker flood water pump	1

#### FR95416

- Electric \*\* pump
- 50mm (2") outlet
- Heavy duty steel cast construction

#### LFH

- Layflat hose for pump discharge
- Available in various sizes



LFH



FR95416

#### Code

<b>FR95416</b>	2" submersible pump with float	1	
<b>LFH210</b>	Layflat hose	2" x 10m	1
<b>LFH250</b>	Layflat hose	2" x 50m	1
<b>LFH2100</b>	Layflat hose	2" x 100m	1
<b>LFH350</b>	Layflat hose	3" x 50m	1

WET CONCRETE EQUIPMENT

**Belle MiniMix  
150 Cement Mixer**

Built for site durability, these are quality, portable mixers for all small to medium building projects. The number one choice for mixers worldwide

- Compact & portable for easy transportation
- Complete with barrow height swivel & stand
- Extra thick drum with quick mix paddles
- CE compliant with NVR (No Volt Release) safety power switch
- 130 litre drum capacity



Code

**BMM150-230V**

**BMM150-110V**

**PDU Drive  
Unit**

Petrol unit to power flexible drive pokers or submersible pumps. Extra tough large diameter tubular steel frames

- Tough 32mm steel tube engine protection
- Fully welded frame for extra durability
- Drive coupling choices suitable for most makes of poker
- Honda GX160 engine

**Power HP/kW**  
5.5/4.0  
**Weight Kg** 23  
**Guaranteed sound power dB**  
94.5  
**Speed RPM**  
2800  
**Height mm** 515  
**Width mm** 445  
**Length mm** 405



Code

**FR92776**

**Aluminium  
Dapple Bars**

- 900mm Aluminium Dapple Bar
- Cranked Handle
- A high quality, lightweight aluminium fully powder coated & welded flowing screed dapple bar
- Includes a 38mm bottom bar and cranked handle for superior 'moveability' when using on site.



Code

**DAP0900** 900mm

ORDER **6AM TO 7PM** FOR NEXT MORNING DELIVERY

Set up an account for our discounted rates / prices

# HAND TAMPERS & BREAKER STEELS

## Hand Tampers

Choose beam lengths to suit your bay widths, allow a minimum of 0.1m overhang.  
Special size hand tampers made to order, sizes from 4.2 to 7.2m

- Aluminium Beam section, light & easy to use
- Solid handles, improves control, work without bending
- Smooth surfaces, just hose down after use



Code		Beam width mm	Beam height mm	Overall length m	Handle mm	Weight Kg
<b>FR93282</b>	4.2 metre beam length hand tamp c/w handles	28/32	102	4.72	680	20
<b>FR93113</b>	5.2 metre beam length hand tamp c/w handles	28/32	102	5.72	680	25
<b>FR93114</b>	6.2 metre beam length hand tamp c/w handles	28/32	102	6.72	680	30
<b>FR93115</b>	7.2 metre beam length hand tamp c/w handles	28/32	102	7.72	680	35

## Points, Chisel & Tarmac Steels

- Forged, ground, hardened & tempered for the highest performance
- 1¼" (32mm) & 1" (25mm) shanks
- Other sizes are available



**P81054**  
Tarmac cutter



**P81042**  
Moil point



**P81027**  
Narrow chisel



**WBP2022**  
Clay spade



Code		Shaft mm	Length from collar inches / mm	Cutter size inches / mm	Weight Kg	
<b>P81042-25</b>	Moil point	25	18 / 450		4	10
<b>P81042-32</b>	Moil point	32	18 / 450		4	2
<b>P81027-25</b>	Narrow chisel	25	18 / 450		4	5
<b>P81027-32</b>	Narrow chisel	32	18 / 450		4	2
<b>P81054-25</b>	Tarmac cutter	25	10 / 250	4.5 / 115	4	2
<b>P81054-32</b>	Tarmac cutter	32	10 / 250	4.5 / 115	4	2
<b>WBP2022</b>	Clay spade	32	18 / 450		4	8

### Red Range - Plate Compactors FPC

- The advantages of a lightweight plate with the features of a heavyweight
- Very low vibration levels without the additional weight
- Double mounted, mass plate anti-vibration system
- Total engine protection frame
- Optional paving mat available
- Optional transport wheels available
- 300, 320, 350, 400 & 450mm plates
- UK built
- Honda engines



Code		Power HP/kW	Centrifugal force kN	Plate size W & L mm	Compaction ratio Kg/m <sup>2</sup>	Guaranteed sound power dB	HAV level m/sec <sup>2</sup>	Weight Kg
<b>FR93132</b>	FPC320 Plate compactor	3.0 / 2.2	10	320 x 318	527	105	3.04	52
<b>FR93122</b>	FPC350 Plate compactor	5.5 / 4.0	14	350 x 348	566	108	2.95	65
<b>FR93125</b>	FPC400 Plate compactor	5.5 / 4.0	14	400 x 348	494	108	2.60	67
<b>FR93133</b>	FPC450 Plate compactor	5.5 / 4.0	14	450 x 348	451	108	2.87	69

### Red Range - Plate Compactors FPL

- A lightweight plate with heavyweight features
- “Soft feel” handle for operator comfort
- Low vibration levels without the additional weight
- Mechanical lifting point
- 300 & 320mm plates
- Honda engine



Code		Power HP/kW	Centrifugal force kN	Plate size W & L mm	Compaction ratio Kg/m <sup>2</sup>	Guaranteed sound power dB	HAV level m/sec <sup>2</sup>	Weight Kg
<b>FR94217</b>	FPL320 Plate compactor	3.0 / 2.2	10	320 x 318	527	105	6.10	52
<b>W14783</b>	FPL320 Water sprinkler kit							

ORDER 6AM TO 7PM FOR NEXT MORNING DELIVERY

Set up an account for our discounted rates / prices

COMPACTION EQUIPMENT

Red Range -  
Plate Compactors FPCL

- A lightweight plate with heavyweight features
- Lower mounted handle for versatile operation
- Folding handle, will fit into the boot of most cars
- 350, 400 & 500 base width - covers a range of applications
- 350, 400 & 450mm plates
- Honda engines



Code		Power HP/kW	Centrifugal force kN	Plate size W & L mm	Compaction ratio Kg/m <sup>2</sup>	Guaranteed sound power dB	HAV level m/sec <sup>2</sup>	Weight Kg
FR94252	FPCL 350 Honda GX160	5.5 / 4.0	14	350 x 348	583	108	9.6	65
FR94253	FPCL 400 Honda GX160	5.5 / 4.0	14	400 x 348	523	108	8.3	67
FR94254	FPCL 450 Honda GX160	5.5 / 4.0	14	450 x 348	477	108	9.0	69



**Floor Saws**

- Right or left hand cutting enabled by dual flanges and reversible guard (MFS500H only)
- Long guide pointer for accurate cutting
- Compact dimensions for high manoeuvrability & easy transportation
- Water tank over the blade for increased stability in the cut
- Petrol engines with cyclonic air filters for prolonged working in dusty conditions
- Hand wheel operated blades raising & lowering
- Honda engine
- Blade not included (see pages 9 - 30)



Power HP/kW  
5.5/4.0

Weight Kg 185

Guaranteed sound power dB  
108

Centrifugal force kN  
10

Vibrator frequency VPM  
4560

HAV level m/sec2  
4.8

Code	Power HP	Blade dia. mm	Max cut depth mm	Water tank capacity litres	Sizes L x W x H mm	Weight Kg
FR94410	MFS350H Fairport 5.5	350	135	31	1516 x 568 x 1000	106
FR94409	MFS500H Fairport 13	450	184	31	1696 x 632 x 1010	125

**FOR OUR FULL RANGE OF QUALITY DIAMOND BLADES TO SUIT**



**SEE PAGES 11 - 35**



## CUT-OFF SAWS

### STIHL Petrol Cut-Off Saw 14"

- Compact design and optimised balance for excellent cutting and guide characteristics
- Long-life filter system with cyclone pre-separation minimises maintenance
- Extremely low vibration levels ( $3.9\text{m/s}^2$ )
- For use with 350mm/14" cutting wheel
- Blade not included (see pages 11 - 35)



Code

TS420

### STIHL Petrol Cut-Off Saw 12"

- Compact design and optimised balance for excellent cutting and guide characteristics
- Long-life filter system with cyclone pre-separation minimises maintenance
- Extremely low vibration levels ( $3.9\text{m/s}^2$ )
- For use with 300mm/12" cutting wheel
- Blade not included (see pages 11 - 35)



Code

TS410

### STIHL Battery Cut-Off Saw

- Compact and lightweight design for unrestricted mobility and flexibility
- Completely emission-free for clean work both indoors and outdoors, even in confined spaces
- Starts quickly and easily at the touch of a button
- For use with 230mm/9" cutting wheel
- Blade not included (see pages 11 - 35)



Code

TSA230

### Husqvarna Petrol Cut-Off Saw

- Compact and lightweight machine producing a superb power-to-weight ratio
- Improved digital ignition enables easy starting and efficient combustion with optimized engine timing
- Maintenance-free starter, strong poly-V belt and efficient filter-system ensure long service intervals and minimal downtime
- For use with 300mm/12" cutting wheel
- Blade not included (see pages 11 - 35)



Code

K770

TRAILER PARTS

**Breakaway Cable**

- Overall length 1010mm



Code

TP324



1

**Tow Ball & Hitch Pin**

- Hitch '3500'kg (D=17.5kn, 5=250kg)
- Pin & wire '3500'kg



TP326



TP325

Code

TP325 Hitch

TP326 Pin & wire



1

1

**Trailer Number Plate Clips**

- Spring loaded rectangular type



Code

TP327



1

**Trailer Light Board**

- 4' c/w 5m cable
- 7 pin plug



Code

TP328



1

Jockey  
Wheels



TP332

TP334

Code		
TP332	43mm - smooth shaft	1
TP333	48mm - smooth shaft	1
TP334	48mm - serrated shaft	1

Jockey Wheel  
Brackets



TP335

TP336

Code		
TP335	Bracket cast 43mm	1
TP336	Bracket cast 48mm	1

Coiled Connection  
Lead

- 2.5m
- 7 pin (plug/plug)



Code		
TP329		1

Plastic Plug  
& Socket

- 12N
- 7 pin



TP330

TP331

Code		
TP330		1
TP331		1

**AUTOMOTIVE SUPPLIES**

**Screen De Icer**

- 500ml spray can



Code  **DE500** 12

**Screen Wash**

- 5 litre
- Ready mixed



Code  **SWASH** 4

**Anti Freeze**

- Effective to -36°C
- Handy 500ml ready to use or 5 litre concentrated



Code  **AF500ML** 500ml ready to use 6  
**CAF5L** 5 litre concentrated 2

**Ice Scraper**

- Extra soft grip handle
- Colour/design may vary



Code  **ICES1** 24

**Heavy Duty Jump Leads**

- Zinc coated crocodile clips
- 2.5m cable
- 200 Amp



Code  **HDJL100** 1

**AdBlue Additive**

- 10 litre
- With spout



Code  **ADBLUE10** 40

**Plastic Fuel Cans**

- 5 litre



Code		
<b>FCPG05</b>	Green	6
<b>FCPR05</b>	Red	6
<b>FCPB05</b>	Black	6

**Double Foot Pump**

- 1.1kg
- Durable metal
- Multi-purpose



Code		
<b>DFP100</b>		10

**Puncture Repair Kit**

- 5 repair patches included
- Solvent and scourer included
- Suitable for any inner tube tyres



Code		
<b>PRKIT</b>		16

**Air Compressor 12v**

- With inbuilt gauge
- 30cm hose
- Thumb lock
- 2.5m cable



Code		
<b>AIRC12V</b>		12

**AUTOMOTIVE MAINTENANCE & CLEANING**

**Car Seat Cover Set**

- Universal fit
- Water, oil & grease resistant
- Durable nylon
- Air bag friendly
- Easy to clean



Code

**CARSCBU**

10

**Van Seat Cover Set**

- Universal fit
- Water, oil & grease resistant
- Durable nylon (standard)
- 100% waterproof fabric (heavy duty)
- Air bag friendly
- Easy to clean
- 1 x single seat
- 1 x twin seat



Code

**VANSCBU** Standard

**HDVANSC** Heavy duty

10  
10

**Car Mats - 4 Set**

- Colours may vary



Code

**CARMAT4**

10

**Truck Wash Traffic Film Remover**

- 20 litre
- Removes traffic film & grease
- For use with pressure washers



Code

**TRUCKW80**

1

**Car Wash & Wax**

- 5 litre
- Showroom finish
- High gloss



Code

**CARSWS**

4

**SPILL KITS & CONTAINMENT**  
**PAGES 228 - 229**



**CLOTHS & SPONGES**  
**PAGE 211**



# SAFESMART ACCESS



Insta-Deck & Mini Mobile Scaffold	432
Scaffold Tower	433
Portable Truck Access Stairs & Edge Protection	434
Portable Aluminium Stairs	435
Safeloader Platforms	436
Super Maintenance Podium	437
Stagings	438
Extension Ladders	439
Ladders & Steps	440
Ladders	441
Step Ladders	442
Platform Ladders & Step Ups	443
Access Podiums	444

CONTACT US  
FOR OUR  
**COMPLETE  
ACCESS  
BROCHURE**



# INSTA-DECK & MINI MOBILE SCAFFOLD

## Insta-Deck Scaffold

- Minimum platform height: 450mm
- Maximum platform height: 870mm
- Platform width: 600mm
- Weight: 26.8kg
- Safe working load: 200kg
- Folds flat for storage



**200kg**  
WEIGHT  
RATING

**WE  
HIRE**



Code

200205



1

## SafeSmart Mini Mobile Scaffold

- Quick & easy to erect
- Available in the following platform heights: 0.6m, 1.6m, 2.1m, 3.1m, 3.6m, 4.6m, 5.1m & 6.1m
- Width: 0.78m
- Length: 1.8m
- Maximum load per platform: 275kg
- Made from 2" tube
- Based on robust industrial tower specifications
- 1 piece folding toe-board set
- Base can be used alone or increased by a further 3 lifts, giving an extra 6 platform heights (using extra components)
- Complies with BS1139 (Part 3) 1994 BSEN 1004



**CALL FOR  
OUR FULL  
RANGE OF  
SIZES &  
PRICES**

**WE  
HIRE**



Code	Description	Max Plat. Height	Max Reach Height
200041	Standard tower	0.8m	2.8m
200042	Standard tower c/w toe board	1.8m	2.8m
200043	Standard tower c/w toe board & stabiliser	2.5m	4.5m
200045	Standard tower c/w toe board & stabiliser	3.5m	5.5m
200046	Standard tower c/w toe board & stabiliser	4.3m	6.3m
200047	Standard tower c/w toe board & stabiliser	5.3m	7.3m
200048	Standard tower c/w toe board & stabiliser	6m	8m

### SafeSmart Aluminium Scaffold Tower

- Length: 2.5m
- 275kg working load per platform - maximum 950kg per tower
- Integral ladders
- Self-closing trapdoor
- Phenol platform tops for good anti-slip properties
- Conforms to 3T erection/ dismantling method
- 150mm adjustable castors
- AGR also available

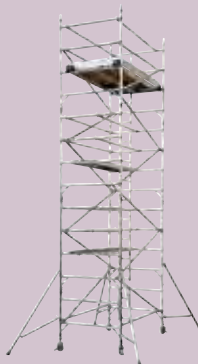

CALL FOR CURRENT BEST RATES

WE HIRE



Code

Single width (0.85m)

200049	Platform height: 1.2m	Reach height: 3.2m
200050	Platform height: 2.2m	Reach height: 4.2m
200051	Platform height: 3.2m	Reach height: 5.2m
200052	Platform height: 4.2m	Reach height: 6.2m
200053	Platform height: 5.2m	Reach height: 7.2m
200054	Platform height: 6.2m	Reach height: 8.2m
200055	Platform height: 7.2m	Reach height: 9.2m
200056	Platform height: 8.2m	Reach height: 10.2m
200057	Platform height: 9.2m	Reach height: 11.2m
200058	Platform height: 10.2m	Reach height: 12.2m
200059	Platform height: 11.2m	Reach height: 13.2m
200060	Platform height: 12.2m	Reach height: 14.2m

Double width (1.45m)

200073	Platform height: 1.2m	Reach height: 3.2m
200074	Platform height: 2.2m	Reach height: 4.2m
200075	Platform height: 3.2m	Reach height: 5.2m
200076	Platform height: 4.2m	Reach height: 6.2m
200077	Platform height: 5.2m	Reach height: 7.2m
200078	Platform height: 6.2m	Reach height: 8.2m
200079	Platform height: 7.2m	Reach height: 9.2m
200080	Platform height: 8.2m	Reach height: 10.2m
200081	Platform height: 9.2m	Reach height: 11.2m
200082	Platform height: 10.2m	Reach height: 12.2m
200083	Platform height: 11.2m	Reach height: 13.2m
200084	Platform height: 12.2m	Reach height: 14.2m

### Scafftag & Laddertag Kits



SCF01

SCF09

Code

- SCF01 Scafftag kit (10 holders, 20 inserts & 1 pen)
- SCF09 Laddertag kit (10 holders, 10 inserts & 1 pen)



1  
1

**PORTABLE TRUCK ACCESS STAIRS & EDGE PROTECTION**

**SafeSmart Portable Truck Access Stairs**

- Anti-skid rubber at the top of the stair
- Unique strutlock fittings ensure the stair stays rigid, safe & sturdy at all times
- Developed specifically for access to truck trays
- Folds flat for storage
- Large support foot
- Self levelling steps
- 6 step is pictured
- 300kg SWL
- BS EN 12811: Class B



STRUTLOCK FITTING

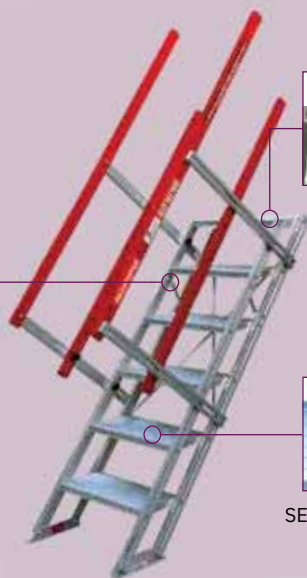

RIBBED RUBBER GRIP SECTION

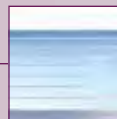

SELF LEVELLING STEPS

**300kg**  
WEIGHT RATING

**FOC**  
SITE DEMO

**WE**  
HIRE

Code

**210294**



1

**SafeSmart Truck Loading Podium**

- Built tough with 82 x 50mm Marine grade aluminium RHS
- Perforated & swaged deck for superior traction in wet and greasy conditions
- Foam filled tyres
- Anti-slip rubber feet
- Solid non slip treads
- Various configurations with options for single gate, salon gates, batwings
- Various heights available



CALL FOR OUR FULL RANGE OF SIZES & PRICES

**FOC**  
SITE DEMO



**✓ DEMO**

**✓ HIRE**

Code

**210196** 5 step 1400m platform height

**210195** 4 step 1130m platform height

## SafeSmart Adjustastairs

- Adjustable & self levelling aluminium safety stair
- Safe, fast, easy access between floors during construction
- Folds flat for easy storage
- Durable & built to last
- Width: 600mm
- BS EN 12811: Class B



**500kg**  
WEIGHT  
RATING

SELF  
LEVELLING

FOC  
SITE  
DEMO

WE  
HIRE



✓ DEMO

✓ HIRE

Code	Steps	Height	Height Adjustments	Weight	SWL	
<b>210290</b>	3 steps	0.8m	0.4 - 0.7m	20kg	500kg	1
<b>210291</b>	6 steps	1.8m	0.9 - 1.4m	38kg	500kg	1
<b>210292</b>	9 steps	2.7m	1.4 - 2.0m	55kg	500kg	1
<b>210293</b>	12 steps	3.7m	1.8 - 2.7m	73kg	500kg	1
<b>210295</b>	15 steps	4.8m	2.2 - 3.4m	93kg	500kg	1
<b>210296</b>	18 steps	5.4m	2.7 - 4.1m	108kg	500kg	1

ORDER **6AM TO 7PM** FOR NEXT MORNING DELIVERY

Set up an account for our discounted rates / prices

# SAFELoader PLATFORMS

## SafeSmart - Truck and Heavy Vehicle Loading Access Platform

- Comes standard with fork lifting channels and crane lifting points
- Fully cross braced aluminium frame, creating total rigidity throughout platform
- Self closing gate at entrance to platform
- 200mm heavy duty castors, Fully height adjustable through 350mm



✓ DEMO

✓ HIRE

Code	Platform height	Platform Dimensions - Description	
210694	2m	0.7mW x 1.4mH x 2.0mL Platform, Stairs one end	1
210695	4m	0.7mW x 1.4mH x 4.0mL Platform, Stairs one end	1
210696	6m	0.7mW x 1.4mH x 6.0mL Platform, Stairs one end	1

## Stepover 70° Ladder Range

- Standard ladder has rubber feet which can be changed for retro-fit permanent feet plates which will attach to the support surface
- Includes two ladder handrails which attach to the ladder style and the main platform handrail posts



Code	
210700	1
210701	1
210702	1
210703	1
210704	1

## Stepover 45° Ladder Range

- Simple to fix to a concrete/solid base or can be pinned for temporary use
- Includes two ladder handrails which attach to the stair and the main platform handrail posts
- Custom sizes, please enquire



Code	
210736	1
210737	1
210738	1
210739	1
210740	1

## SafeSmart Super Maintenance Podium

- Engineer's approval, SWL rating & serial number on certification plate
- Tough build with 82 x 50mm marine grade aluminium RHS - won't corrode or weaken with age
- Perforated & swaged deck for superior traction in wet & greasy conditions
- Large solid rubber wheels for ease of movement
- 7 - 11 step models come with retro-fittable outriggers as standard
- Comes with operator safety manual & assembly instructions
- BS EN 131-7: 2013
- Option for front gate access



PERFORATED ANTI-SLIP PLATFORM



225kg  
WEIGHT  
RATING

FOC  
SITE  
DEMO

WE  
HIRE



ERGONOMIC  
LIFTING  
HANDLES

RUBBER FEET



FOAM WHEEL



✓ DEMO

✓ HIRE

Code	Platform height	Platform size	Steps	
210183	565mm	800 x 1800mm	2 steps	1
210284	850mm	800 x 1800mm	3 steps	1
210185	1130mm	800 x 1800mm	4 steps	1
210186	1400mm	800 x 1800mm	5 steps	1
210187	1700mm	800 x 1800mm	6 steps	1
210188	1970mm	1000 x 2000mm	7 steps	1
210189	2250mm	1000 x 2000mm	8 steps	1
210190	2540mm	1000 x 2000mm	9 steps	1
210191	2828mm	1000 x 2000mm	10 steps	1
210192	3100mm	1000 x 2000mm	11 steps	1

ORDER 6AM TO 7PM FOR NEXT MORNING DELIVERY

Set up an account for our discounted rates / prices

**STAGINGS**

**Aluminium Lightweight Stagings**

- Strong stable platforms
- Aluminium stiles & cross bearers for strength
- Phenol anti-slip board
- Handrail system can be clamped on for safe working at height
- BS2037 certified - 270kg distributed load
- Also available in 450mm width



STAGING  
HANDRAIL  
SYSTEM



600mm  
WIDE  
STAGING



Code	Length		
<b>600mm wide staging</b>			
200032	2.50m		1
200033	3.05m		1
200034	3.65m		1
200035	4.20m		1
200036	4.80m		1
200037	5.40m		1
200038	5.95m		1
200039	6.55m		1
200040	7.10m		1
<b>Staging handrail system</b>			
200020	0.45m	Handrail post	1
200021	0.60m	Handrail post	1
200022	6.0m	Aluminium handrail tube	1

**CALL 020 8311 1144**

**FREE ON-SITE DEMOS  
AVAILABLE FOR ALL  
ACCESS PRODUCTS**

**MANY PRODUCTS  
ALSO AVAILABLE  
FOR HIRE**





## Triple Combination Ladders

- 3 way use: step ladder, extension ladder & free standing extension ladder
- Easy conversion
- Stabiliser for stability
- Lightweight aluminium
- 150kg load rating
- EN131 certified

150kg  
WEIGHT  
RATING



Code	Closed length	Extension length	Free standing extension length	
<b>200098</b>	1.85m	4.94m	2.92m	1
<b>200099</b>	2.41m	5.44m	3.76m	1
<b>200100</b>	2.97m	6.84m	4.88m	1
<b>200101</b>	3.53m	8.24m	5.72m	1
<b>200102</b>	4.09m	9.92m	6.56m	1

## Aluminium Extension Ladders

- Easy to use, free standing extension ladder
- Stabilisers for stability
- Lightweight aluminium construction
- BS EN 131

150kg  
WEIGHT  
RATING



Code	Closed length	Open length	
<b>Double</b>			
<b>210080</b>	3.10m	5.13m	1
<b>210081</b>	3.68m	6.29m	1
<b>210082</b>	4.26m	7.45m	1
<b>210083</b>	4.84m	8.61m	1
<b>210084</b>	5.42m	9.77m	1
<b>Triple</b>			
<b>210085</b>	3.10m	7.45m	1
<b>210086</b>	3.68m	9.19m	1

## Fibreglass Extension Ladders

- Easy to use, free standing extension ladder
- Stabilisers for stability
- Lightweight fibreglass construction
- Non-conductive
- Semi-automatic locks

150kg  
WEIGHT  
RATING



Code	Closed length	Open length	
<b>210076</b>	3.03m	5.06m	1
<b>210077</b>	3.61m	6.22m	1
<b>210079</b>	4.48m	7.96m	1

## LADDERS & STEPS

### Aluminium Swingback Step Ladder

- Channel section stiles
- Box section back legs
- Rubber feet
- Hinged locking stays
- EN131

**150kg**  
WEIGHT  
RATING



Code	Length	Treads	Kg	
200103	0.82m	4	4	1
200104	1.05m	5	5	1
200105	1.27m	6	6	1
200106	1.5m	7	7	1
200107	1.72m	8	8	1
200108	2.17m	10	10	1
200109	2.62m	12	12	1

### Fibreglass Step Ladder

- Reinforced moulded plastic top
- Wide serrated treads
- Hinged locking stays
- EN131

**150kg**  
WEIGHT  
RATING



Code	Length	Treads	Kg	
200111	1.2m	4	4	1
200112	1.5m	5	5	1
200113	1.8m	6	6	1
200114	2.4m	8	8	1
200115	3.0m	10	10	1

### Trade Series Telescopic Ladders

- Extends 0.77 - 3.2m & locks rung by rung (11 rungs)
- Reinforced nylon couplings
- Precision engineered aerospace grade aluminium
- Compacts down for ease of storage
- 10.6kg
- 1 year warranty
- 150kg load rating
- EN131



**150kg**  
WEIGHT  
RATING

Code	
200116	1

## Wooden Pole Ladders

- Finest quality heavy duty
- Matched Scandinavian whitewood stiles finished with two coats of ladder preservative
- Hardwood rungs



Code	Size	
200006	3m	1
200007	4m	1
200008	5m	1
200009	6m	1

## Steel Pole Ladders

- High quality steel ladder
- Fully coated
- Rubber feet

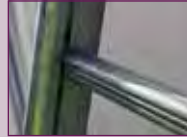

Code	Size	
200013	3m	1
200014	4m	1
200015	5m	1
200016	6m	1

## Aluminium Straight Ladders

- Unique frame design
- Stabilisers for stability
- Lightweight aluminium
- Meets BS2037 Class 1
- Other sizes available - just call us



**150kg**  
WEIGHT  
RATING



Code	Length	
210338	3m	1
210340	4.2m	1
210341	4.8m	1
210342	6.0m	1

ORDER **6AM TO 7PM** FOR NEXT MORNING DELIVERY

Set up an account for our discounted rates / prices

## STEP LADDERS

### Aluminium Adjustastep Platform

**150kg**  
WEIGHT RATING

- Height adjustable for working off a large safe platform at variable heights
- Platform heights adjusted through each ladder's range in seconds
- Set front and back stiles to varying heights for working on steps or uneven ground
- Handrail allows for 3 points of contact
- Large rubber feet for stable grip and hard wearing
- Rated to 200kg for industrial applications
- One-piece, smooth operation – simply folds flat and locks
- Can be fitted with accessories – tool bucket and full surround handrail



✓ DEMO

✓ HIRE

Code	Type	Height	Overall Stile Length	Weight	
210261	4-7 Step	1.15m - 2.02m	2.27m - 3.14m	8.0kg	1

### Trade Series Platform Ladder Accessories

- Full surround safety rail creates a safer working environment for any height
- Spring wheeled castors allow users to manoeuvre around work space with ease



Code	Type	
210334	Spring loaded castor	1
210335	Full surround safety rail	1
210336	Trade series Platform Ladder clip-on bucket	1

### Aluminium SafeSmart Platform Ladder

- Large non-slip platform surface
- Simply folds out
- Wide, comfortable treads
- Welded diagonal back brace
- BS EN 131-2: 2010

150kg  
WEIGHT  
RATING



Code	Deck height	Steps	
210300	0.6m	2	1
210301	0.9m	3	1
210302	1.2m	4	1
210303	1.5m	5	1
210304	1.8m	6	1
210305	2m	7	1
210306	2.4m	8	1
210307	2.7m	9	1

### Fibreglass SafeSmart Platform Ladder

- Fully electrically safe
- Large non-slip platform surface
- Simply folds out
- Wide, comfortable treads
- Welded diagonal back brace
- BS EN 131-2: 2010

150kg  
WEIGHT  
RATING

ELECTRICALLY  
SAFE



Code	Deck height	Steps	
210310	0.6m	2	1
210311	0.9m	3	1
210312	1.2m	4	1
210313	1.5m	5	1
210314	1.8m	6	1
210315	2m	7	1
210316	2.4m	8	1
210317	2.7m	9	1

### Low Level Platform Step Up

- 500mm high
- Legs lock out when in use
- Folds away to compact size
- Lightweight

150kg  
WEIGHT  
RATING



Code	Size	
200000	0.6m x 0.3m	1
200001	0.6m x 0.6m	1

**ACCESS PODIUM**

**BS8620  
Podium**

- Lightweight aluminium construction
- Easy to access in and out
- Folds up compactly
- Two height settings
- Can be fitted with anti-surf feet



Code	Platform height	
BS8620-07	0.75m	1
BS8620-1	1.0m	1
BS8620-12	1.2m	1
BS8620-15	1.5m	1
BS8620-17	1.75m	1
BS8620-20	2.0m	1

# SECURASITE



Temporary Fencing	446
Fencing & Vehicle Gates	447
Temporary Fencing Accessories	448
Pedestrian Barriers	450

**TEMPORARY FENCING****Securasite Temporary Fencing**

- Square top
- Anti climb mesh
- 2800mm (H) x 3800mm (W)



EXTRA CARRIAGE CHARGE CHARGES MAY APPLY

Code

SCAC40

**Securasite Temporary Fencing**

- Round top
- Anti climb mesh
- 2000mm (H) x 3500mm (W)



EXTRA CARRIAGE CHARGE CHARGES MAY APPLY

Code

SCRT40



## Securasite Fencing Gates

- Access for pedestrians on site
- 2000mm (H) x 1200mm (W)

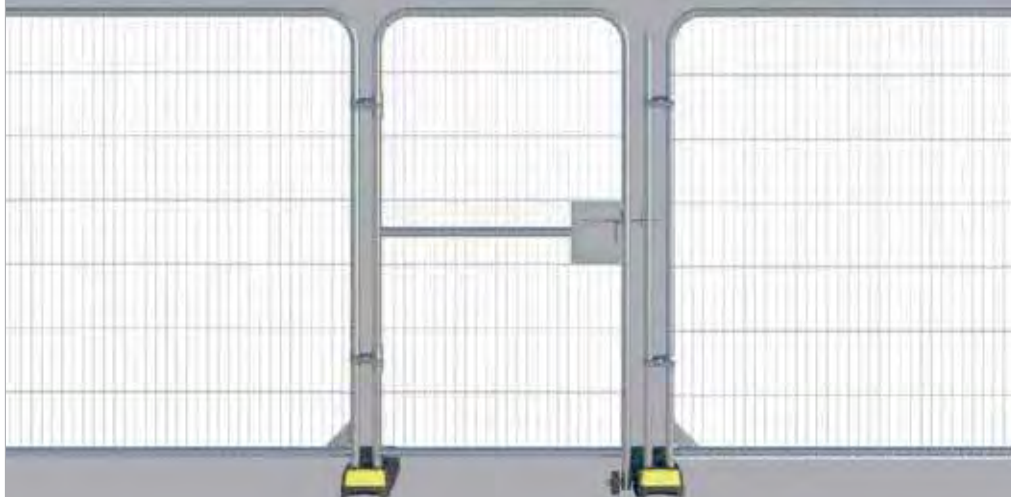

Code

SCAPGRT

## Securasite Vehicle Gates

- Access for vehicles on site
- 2000mm (H) x 4200mm (W)

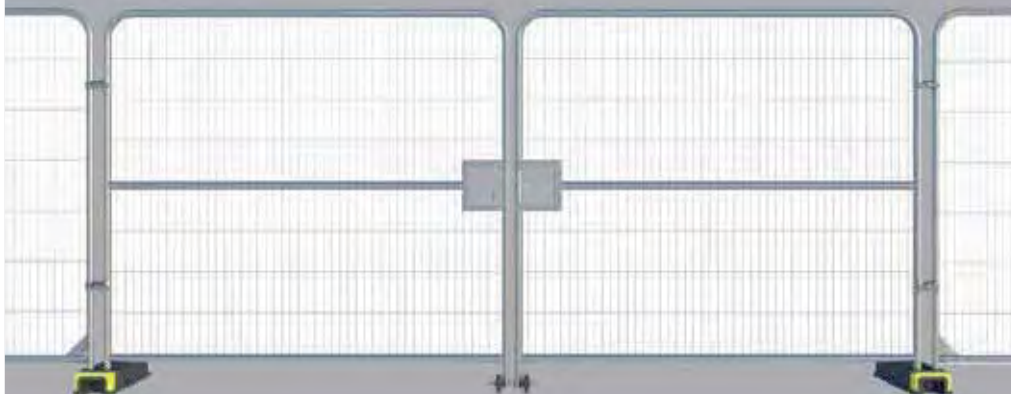

Code

SCRVGRT

**TEMPORARY FENCING ACCESSORIES**

**Standard Thermoplastic Foot**



Code  
SCATF

**Fence Coupler**

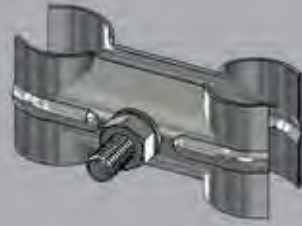

Code  
SCAFC

**Fence Spanner**



Code  
SCALS

**Lockable Coupler**



Code  
SCALCS

**Fence Stabiliser**



Code  
SCAS

**FlexiStrip Reflective Strips for Mesh Fencing**



Code  
FLEXSTR



## SOUND CONTROL SOLUTIONS

Hushtec Global was born with a passion of bringing to market innovative solutions that protect people, the environment and increase health and safety measures across a wide range of industries.



**FOR MORE  
DETAILS  
SEE PAGES  
235-239**

# PEDESTRIAN BARRIERS

## Fixed Leg Barrier

- The Securasite Pedestrian Barriers are a system of interlocking, free standing panels that are fast to install, durable and easy to stack when not in use.
- Ideal for construction sites, public events or sporting venues



EXTRA CARRIAGE CHARGE CHARGES MAY APPLY

Code

SCPB23

## Fixed Leg Walkthrough

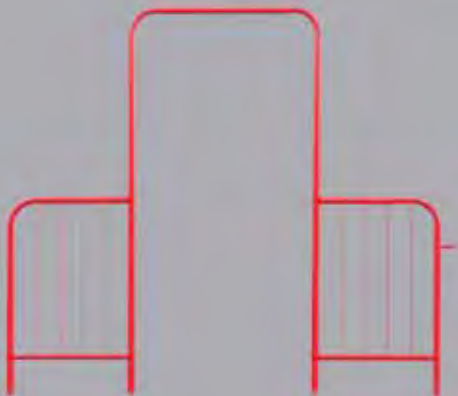

Code

SCAFLW

## Fixed Leg Walkthrough with Gate

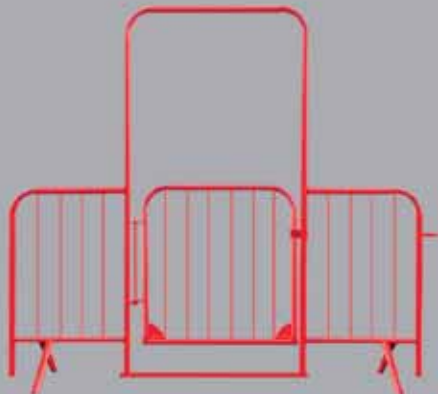

Code

SCAFLWGATE

# TRAFFIC MANAGEMENT



Barriers	452-455
Trench Covers & Kerb Ramps	456
Speed Humps	458
Safety Goal Posts	460-461
Road Cones	462
Skipper Unit, Demarcation Poles & Chain Barriers	463
No Waiting Cones, Stop & Go Signs & Verge Posts	464
Flashing Beacons	465
Cone Signs	466-468
Q Signs	470-471
Metal Road Signs	472-477
Outdoor Bins	478

## BARRIERS

### Gate Barrier - 2 Metre

- Sturdy & durable
- Simply lift & connect barriers
- Conforms to EN12899-1 & EN8442

ENQUIRE FOR BULK RATES

BEST SELLER



GATEBA-BLU



GATEBF



Anti-trip feet available



Code			
<b>GATEBF</b>	With standard feet	CALL FOR BULK RATES	40
<b>GATEBA</b>	With anti-trip feet	CALL FOR BULK RATES	40
<b>GATEBA-BLU</b>	Blue with anti-trip feet	CALL FOR BULK RATES	40
<b>RSSB-FOOT</b>	Replacement standard foot	CALL FOR BULK RATES	40

### Titan Plastic Injection Moulded Barrier - 2 Metre

- Unrivalled strength, increased rigidity from additional vertical bars, great stability with new airflow features
- Surelock QR™ linking facility compatible with other JSP barriers
- Grommets for signage
- Reflective panel
- Carry handle
- Locks together for transport
- Fully recyclable
- Anti-trip feet available



Code			
<b>RSTB200</b>	With standard feet	CALL FOR BULK RATES	40
<b>RSTB200AT</b>	With anti-trip feet	CALL FOR BULK RATES	40

### Avalon Blow Moulded Barrier - 2 Metre

ENQUIRE FOR BULK RATES

- Secure even on uneven ground
- Unlocked or locked mode
- Signage can be fixed to back or front
- Bespoke colour barriers available
- Complies with BS 7818



Code			
<b>RSVA200</b>	With standard feet	CALL FOR BULK RATES	50
<b>RSVA200AT</b>	With anti-trip feet	CALL FOR BULK RATES	50
<b>RSVAFOOT</b>	Foot only	CALL FOR BULK RATES	1

**Utility Barrier - 0.75 Metre**

- Sturdy & durable
- Simple system & easy to connect
- Four gates
- 1m(H) x 75cm(W)
- Conforms to EN12899-1



Code

**RSUB7570**



20

**Safegate Communication Barrier - 4 Gate System**

- Integral locking clamp for extra stability when deployed in a straight line
- Lightweight - only 2kg per barrier
- Environmentally friendly - 100% recyclable
- Compliant with Chapter 8 Streetworks
- Modular design



Code

**RSSG1**



20

**Barricade Expandable Safety Barrier**

- Extended: 4000 x 300 x 950mm
- Folded: 450 x 300 x 950mm

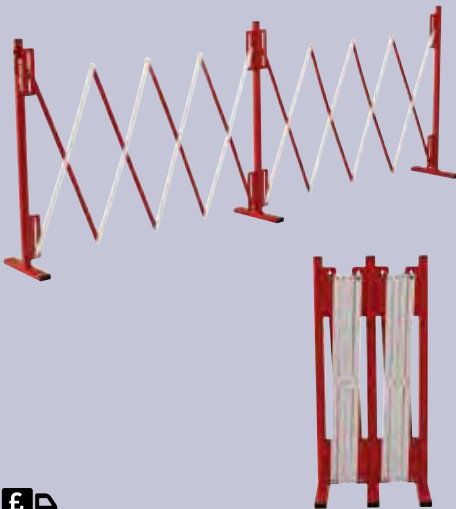

Code

**RSBCON04**



10

**Armorgard InstaGate™**

- Easily moved and deployed by one person
- IG4 - 1380mm high, closed length 440mm, open length 2185mm
- IG6 - 1884mm high, closed length 450mm, open length 2380mm

ENQUIRE FOR BULK RATES

**NEW**



Code

**IG4**



1

**IG6**

1

# KNOW YOUR HEIGHTS



**MINI-DOUBLETOP**

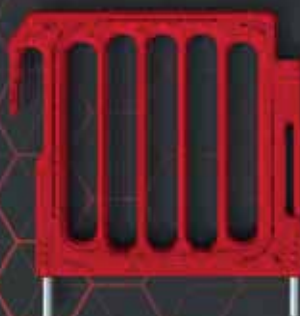

**DOUBLETOP**

**HOG600**



0.56 m

**BUDDHA**



0.80 m

**WONDERWALL**



1.00 m



### Melba Swintex Buddha Barrier

- Water fillable barriers
- Stable & secure stacking model
- Dual reflective strips
- 100% anti-trip design
- Forklift entry spaces
- Lightweight
- 800mm(H) x 1040mm(W) x 280mm(D)

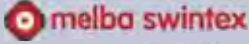

Code			
<b>2BUDDHA-RED</b>	Red	CALL FOR BULK RATES	25
<b>2BUDDHA-WHT</b>	White	CALL FOR BULK RATES	25

### JSP Alphabloc Barrier

- Water fillable barriers
- Unique folding design
- 50% less storage space
- Branding available - MOQ whole pallet
- 1m(L) x 600mm(H) x 400mm(D)



Code			
<b>RSABRED</b>	Red	CALL FOR BULK RATES	40
<b>RSABWHT</b>	White	CALL FOR BULK RATES	40

### Melba Swintex Hog Barrier

- Strong, waterfilled barriers
- Hook & eye system for quick & easy deployment
- Compatible with other systems
- Capacity to hold 55 litres
- 560 x 1130 x 400mm

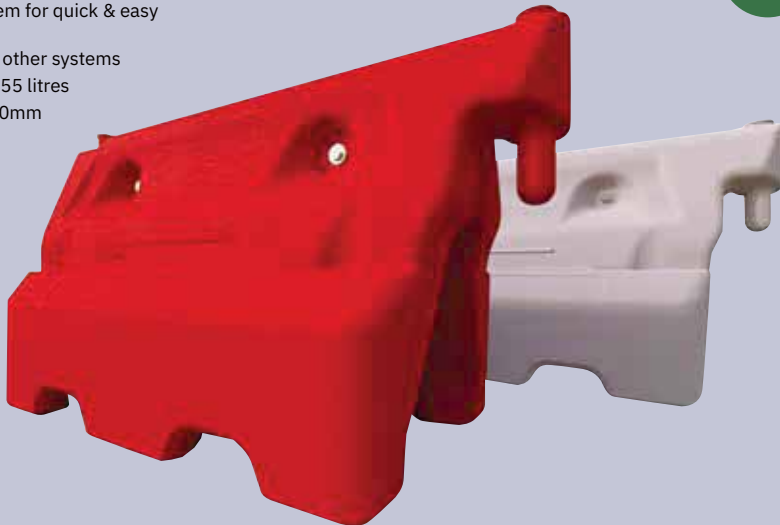

Code			
<b>HOG600-RED</b>	Red	CALL FOR BULK RATES	25
<b>HOG600-WHT</b>	White	CALL FOR BULK RATES	25

## TRENCH COVERS & KERB RAMPS

### Pedestrian Only Trench Cover

- 1125 x 1125mm
- Pedestrians only
- Can withstand a 200kg load over a 700mm trench
- The sides & undersides are made from a soft flexible material which grips the surface underneath the board & helps to resist sliding



Code

RSTCP



30

### Temporary, Lightweight, Anti-Slip Trench Cover

- Designed primarily for use in street works
- Moulded from a single piece of glass reinforced composite

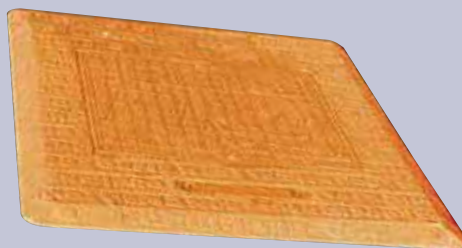

Code

RSTC01 1200x800mm

RSTC02 1600x1200mm



30

25

### Safekerb Ramp

- Effective non-slip surface & raised sides
- Adapts to varying kerb or step heights (75 - 150mm)

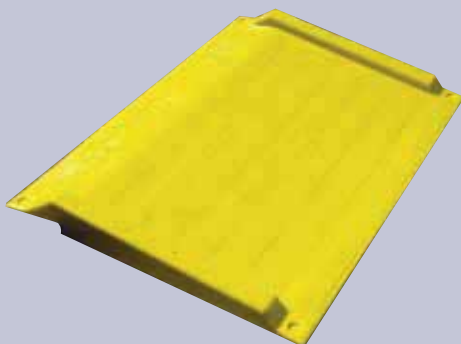

Code

RSSKR



20

### Supagrip Safekerb Ramp

- Effective non-slip surface & raised sides
- Adapts to varying kerb or step heights (75 - 150mm)



Code

RSGSKR



30



# CLOSED LOOP RECYCLING

TURNING UNWANTED PRODUCT INTO NEW

REUSE



REGRIND



REPACK



REMOULD



PRODUCTS MANUFACTURED FROM 100% RECYCLABLE MATERIALS



SIGNS



1PC CONES



BASES

A LONG-STANDING  
**HISTORY** & **RECYCLING**  
commitment



POST CONSUMER  
of **PLASTIC** is  
RECYCLED each week



2PC CONES

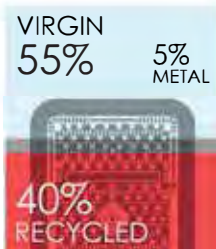

TRENCH COVERS

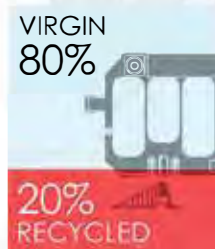

BARRIERS

CLOSED LOOP RECYCLING  
Turn unwanted products into **NEW**



ISO 9001 CERTIFIED  
Striving to **meet & surpass**  
Customer requirements

## SPEED HUMPS

### Cable & Hose Protector Ramp

- 3 x 45cm cable / hose channel
- Strong, hinged lid provides easy access
- Effective speed reducer
- Simple interlocking design
- 7.5cm(H) x 100cm(L) x 60cm(W)
- Weight: 29kg
- Fixings for asphalt or concrete



RSSF2



RSSB2

NEW

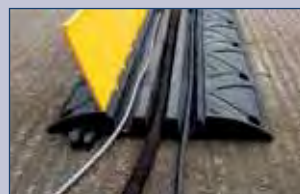
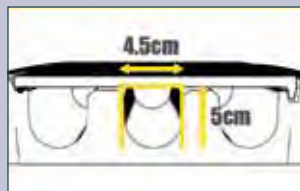

Code

<b>RGBCHP</b>	Ramp	1
<b>RSSF2</b>	Concrete fixings	50
<b>RSSB2</b>	Asphalt fixings	50

### Speed Humps

- Humps supplied in pairs (one of each colour)
- End cap sections supplied in pairs (same colour)
- 50mm high for 10mph zones
- Fixings for asphalt or concrete
- Section dimensions: 5cm(H) x 50cm(L) x 40cm(W)

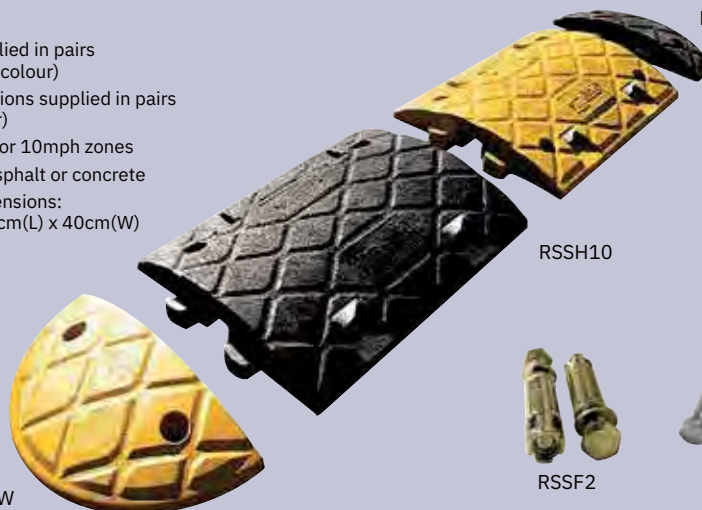

RSSHEYW

RSSH10

RSSHEBK



RSSF2



RSSB2

Code

<b>RSSH10</b>	Speed hump sections (pair)	1
<b>RSSHEYW</b>	End cap sections (pair, yellow)	1
<b>RSSHEBK</b>	End cap sections (pair, black)	1
<b>RSSF2</b>	Concrete fixings	50
<b>RSSB2</b>	Asphalt fixings	50

**CONSTRUCTION  
& CIVILS**



**HIGHWAYS**



**INDUSTRIAL**



**UTILITIES**



**SAFETY GOAL POSTS**

**GS6 Telescopic Goalpost Kit**

- Height restriction goal posts kit
- 2x 7.3m poles
- 2x metal plate bases
- 1x 25m bunting

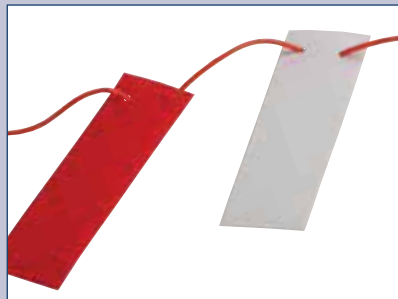

Code

GS6SETM



## Safety Goalpost System

- HSE GS6 compliant
- Non-conductive
- Maximum height: 7.5m
- Minimum height: 1.8m
- Capped end for bunting
- Red & white poles for extra visibility
- 1 person assembly
- Cross bar option available

**Set includes two ballast bases, two poles & bunting**



Code

**GLPST1** Goal post set



8

## Pendant Bunting Tape - Red & White

- Length: 26m
- 32 red & white markers

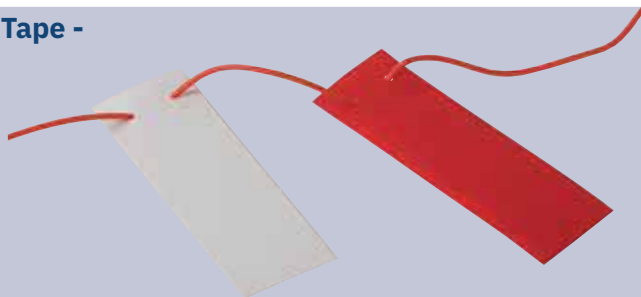

Code

**BUNTRW26**



1

ORDER **6AM TO 7PM** FOR NEXT MORNING DELIVERY

Set up an account for our discounted rates / prices

**461**

## ROAD CONES

### 2 Piece Road Cone

- 100% recycled composite base
- Can be embossed with bespoke logo on side
- Bespoke colour base available
- MOQ for embossing: full pallet



ENQUIRE FOR BULK RATES



Code			
<b>RS2RC450</b>	450mm(H) cone	CALL FOR BULK RATES	300
<b>RS2RC750</b>	750mm(H) cone	CALL FOR BULK RATES	150
<b>RS2RC1000</b>	1m(H) cone	CALL FOR BULK RATES	125

### 1 Piece Road Cone

- 100% recycled
- Can be embossed with bespoke logo on base
- Bespoke colour base available
- MOQ for embossing: full pallet



ENQUIRE FOR BULK RATES



Code			
<b>RS1RC450</b>	450mm(H)	CALL FOR BULK RATES	300
<b>RS1RC750</b>	750mm(H)	CALL FOR BULK RATES	200

### Reflective Cone Sleeves

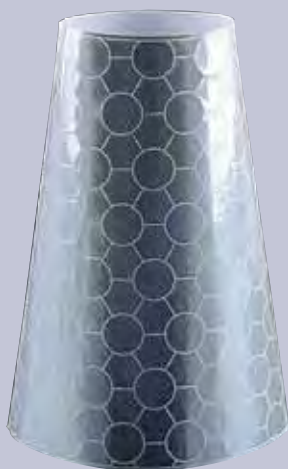

Code			
<b>RSRS450</b>	Reflective Strip for 450mm(H)		1000
<b>RSRS750</b>	Reflective Strip for 750mm(H)		1000
<b>RSRS1000</b>	Reflective Strip for 1m(H)		1000



## CONE BRANDING SERVICE

### BENEFITS INCLUDE:

- Brand Awareness
- Professional Image
- Theft Deterrent

CALL US FOR DETAILS  
**020 8311 1144**

Minimum order quantities may vary per product. Set up costs may apply.



## Orange Skipper Unit Tape

- Unique way to cordon off an area
- Fits on a road cone
- Contains 9m retractable tape



Code

SKIPPER01



15

## Telescopic Demarcation Poles

NEW

- Suits all traffic cones
- Quick & easy to deploy
- Extendable from 1100 to 2200mm



Code

RSTDP-RW



20

## Chain Barrier System

- Multi-functional barrier system to cordon off areas
- Extendable posts with chain support cap
- 3kg base to securely hold post & chain

NEW



Code

**PC258** 25m chain - 8mm

**PCSPRW** Chain support post

**PCBASE** Base



4

4

4

NO WAITING CONES, STOP & GO SIGNS & VERGE POSTS

No Waiting Cone - 1 Piece

- MOQ for embossing full pallet



Code		
RS1NWCT	Triangular	300
RS1NWCC	Circular	300

No Waiting Cone- 2 Piece Triangular

- Weighted base
- MOQ for embossing full pallet



Code		
RS2NWCT		150

Stop & Go Handheld Signs

- Metal or plastic
- Price each



Code		
RSSGSM	Metal	1
RSSGSP	Plastic	1

Wychwood Flexible Verge Posts

- Moulded spring back post
- Large reflective area
- Conforms to EN12899-1 Class R2



Code		
HEV040		10

FLASHING BEACONS

**Maxilite LED - Flashing with Photocell**

- Battery not included
- Takes 2 x **EB6V** (below)
- Cone bracket to suit: RSMULCB



LRSMXLP

LRSMXLR

Code		
<b>LRSMXLP</b>	Orange lens	10
<b>LRSMXLR</b>	Red lens	10
<b>RSMULCB</b>	Cone bracket	50

**Microlite - Flashing with Photocell**

- Battery not included
- Takes 1 x **EB6V** (below)
- Cone bracket to suit: RSMULCB



Code		
<b>RSMLP</b>		50
<b>RSMULCB</b>	Cone bracket	50

**6 Volt Chloride Battery**

- Premium quality
- 24 per box



ENQUIRE FOR BULK RATES

Code		
<b>EB6V</b>		12

**Vision Alert Rotating Amber 12v Beacon**

- 12v
- Magnetic



Code		
<b>RSFLBP</b>		1

**400mm 2 Lamp Rotator Blaze II Minibar**

- ECE R65
- Low profile lens: 110mm
- 12v

601AA01Y



601AA01M



Code		
<b>601AA01Y</b>	1 bolt fixing	1
<b>601AA01M</b>	Magnetic	1

**LED Minibar**

- 8 head
- 1 bolt
- 12-24v DC
- Amber lens

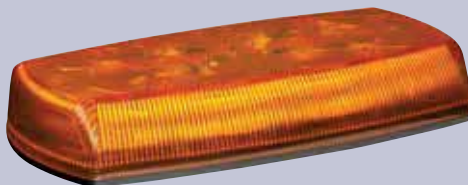

Code		
<b>5580AVA1</b>		1

## CONE SIGNS

- BESPOKE OPTIONS MADE TO ORDER
- A VERY COST EFFECTIVE SIGN SYSTEM
- ALL PLASTIC TO REDUCE METAL THEFT
- EASY STACKING
- LIGHTWEIGHT
- ALL SIGNS ARE REFLECTIVE AND CONFORM TO BS8442

### Choose the correct size of cone and sign

With reference to the type of road and speed limit:  
 Minimum size of signs (mm)  
 Minimum height of cones (mm)

**30** All purpose single carriageway road, urban, restricted to 30mph or less

**40** All purpose single carriageway road, urban, restricted to 40mph or less

**50** All purpose single carriageway road, urban, restricted to 50mph or less

**40** All purpose dual carriageway road, urban, restricted to 40mph or less

**50** All purpose dual carriageway road, urban, restricted to 50mph or more

### 750mm Cone Signs Chapter 8 Kit

- Suitable for 750mm & 1000mm cones
- Cone not included



Code  
RSCSC8/8

### Cone Sign - Men At Work End

- Suitable for 750mm cones
- Cone not included



Code  
RSCS-RWE

**Cone Sign - Men At Work**

- Suitable for 750mm cones
- Cone not included



Code

RSCS-RW

**Cone Signs - Footway Closed / Footpath Ahead Closed**

- 600mm x 450mm
- Cone not included



Code

RSCS-FL

**Cone Sign - Footpath Ahead Closed**

- 600mm x 450mm
- Cone not included



Code

RSCS-FAC

**Cone Signs - Pedestrians Please Use Other Footpath**

- 600mm x 450mm
- Cone not included



Code

RSCS-PPUOF

## CONE SIGNS

### Cone Sign - Road Narrows Left

- Suitable for 750mm cones
- Cone not included



Code

RSCS-RNL

### Cone Sign - Road Narrows Right

- Suitable for 750mm cones
- Cone not included



Code

RSCS-RNR

### Cone Sign - Pedestrians Left

- 600mm x 450mm
- Cone not included



Code

RSCS-PL

### Cone Sign - Pedestrians Right

- 600mm x 450mm
- Cone not included



Code

RSCS-PR

### Cone Sign - Arrow Left

- Suitable for 750mm cones
- Cone not included



Code

RSCS-AL

### Cone Sign - Arrow Right

- Suitable for 750mm cones
- Cone not included



Code

RSCS-AR

# BESPOKE SIGNAGE PRINTED IN-HOUSE FOR NEXT DAY DELIVERY

Choose your layout  
& we'll do the rest

- METAL ROAD SIGNS
- CORREX ROAD SIGNS
- PLASTIC ROAD SIGNS
- PVC SITE SIGNAGE
- CORRUGATED PVC SIGNS
- MANY MORE APPLICATIONS



**YOUR  
TEXT  
HERE**

Q SIGNS

Temporary Plastic Road Signs

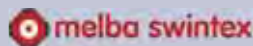

- The Q Sign is a temporary plastic road sign which is extremely strong & robust which gives it durability & a long life
- Pedestrian & car friendly
- It is easy & safe to handle with no sharp edges & has a simple folding system for quick deployment & storage
- Being an all plastic design the product will not conduct electricity or rust
- The product can be completely recycled & reused at the end of its life
- Specific colour front section available with minimum run
- 750mm: 30 per pallet / 600 x 450mm: 50 per pallet

All temporary traffic signs must be able to withstand three different classes of wind speeds with the use of a ballast. The standard BS 8442:2015 states the three classes as the following:

- Class A: 26.3 m/s (58mph)
- Class B: 17.6 m/s (39mph)
- Class C: 8.7m/s (19mph)

The Q-Sign was tested under strict conditions at the Full Scale Wind Tunnel at Mira to determine at which wind speeds the sign can withstand. Below are the results for the 600mm & 750mm Triangle and Circle Q-Sign.

These results are a guide as to the recommended ballast weight for each Wind Class:

<p>Class C <span style="color: green;">✓ Passed</span></p> <p>Withstood up to 26mph</p> <p>Recommended Ballast Weight: 0Kg</p>	
<p>Class B <span style="color: green;">✓ Passed</span></p> <p>Withstood up to 42mph</p> <p>Recommended Ballast Weight: 10Kg</p>	
<p>Class A <span style="color: green;">✓ Passed</span></p> <p>Withstood up to 59mph</p> <p>Recommended Ballast Weight: 30Kg</p>	

Tested at MIRA



## Temporary Plastic Road Signs



### Code

#### 750mm

<b>RSQS-MAW</b>	MEN AT WORK (564)	Triangle
<b>RSQS-RNL</b>	ROAD NARROWS LEFT / NEARSIDE (517)	Triangle
<b>RSQS-RNR</b>	ROAD NARROWS RIGHT / OFFSIDE (517)	Triangle
<b>RSQS-TS</b>	TRAFFIC SIGNALS AHEAD (543)	Triangle
<b>RSQS-SR</b>	SLIPPERY ROAD (557)	Triangle
<b>RSQS-MWE</b>	MEN AT WORK END	Triangle with supp. plate
<b>RSQS-AL</b>	KEEP LEFT BLUE ARROW (610)	Circle
<b>RSQS-AR</b>	KEEP RIGHT BLUE ARROW (610)	Circle

#### 1050 x 750mm

<b>RSQS-RC</b>	ROAD CLOSED	1050 x 750mm
<b>RSQS-RAC</b>	ROAD AHEAD CLOSED	1050 x 750mm
<b>RSQS-RA</b>	RAMP AHEAD	1050 x 750mm
<b>RSQS-TCA</b>	TRAFFIC CONTROL AHEAD	1050 x 750mm
<b>RSQS-HPC</b>	HEAVY PLANT CROSSING	1050 x 750mm
<b>RSQS-RL</b>	WHEN RED LIGHT SHOWS WAIT HERE	1050 x 750mm
<b>RSQS-WA</b>	WORKS ACCESS	1050 x 750mm
<b>RSQS-RCA</b>	ROAD CLOSED ACCESS ONLY	1050 x 750mm
<b>RSQS-NRL</b>	NEW ROAD LAYOUT AHEAD	1050 x 750mm
<b>RSQS-SA</b>	SITE ACCESS	1050 x 750mm

#### 600 x 450mm

<b>RSQS-FC</b>	FOOTWAY CLOSED	600 x 450mm
<b>RSQS-PR</b>	PEDESTRIANS RIGHT	600 x 450mm
<b>RSQS-PL</b>	PEDESTRIANS LEFT	600 x 450mm
<b>RSQS-PP</b>	PEDESTRIANS PLEASE USE OTHER FOOTPATH	600 x 450mm

#### 1050 x 450mm

<b>RSQS-RAMP</b>	RAMP	1050 x 450mm
<b>RSQS-SLOW</b>	SLOW	1050 x 450mm

#### DIVERSION (YELLOW)

<b>RSQS-DLA</b>	DIVERSION LEFT ARROW	1050 x 750mm
<b>RSQS-DAR</b>	DIVERSION RIGHT ARROW	1050 x 750mm
<b>RSQS-DE</b>	DIVERSION ENDS	1050 x 750mm
<b>RSQS-DTLA</b>	DIVERTED TRAFFIC LEFT ARROW	1050 x 750mm
<b>RSQS-DTRA</b>	DIVERTED TRAFFIC RIGHT ARROW	1050 x 750mm
<b>RSQS-DTSA</b>	DIVERTED TRAFFIC STRAIGHT AHEAD ARROW	1050 x 750mm

ORDER **6AM TO 7PM** FOR NEXT MORNING DELIVERY

Set up an account for our discounted rates / prices

# METAL ROAD SIGNS

## Metal Signs 1050mm x 750mm

- 1050mm x 750mm
- All signs supplied come with clips
- Pre-riveted available on request at extra cost



### Complete Sign (Plate, Frame & Clips)

Code

<b>RSMC-AO</b>	ACCESS ONLY
<b>RSMC-CLT</b>	CAUTION LORRIES TURNING
<b>RSMC-CNRM</b>	CAUTION NO ROAD MARKINGS
<b>RSMC-RIOM</b>	CAUTION RAISED IRON WORKS
<b>RSMC-CSE</b>	CAUTION SITE ENTRANCE
<b>RSMC-DDE</b>	DANGER DEEP EXCAVATION
<b>RSMC-DLT</b>	DANGER LORRIES TURNING
<b>RSMC-DIPNA</b>	DECKING IN PROGRESS - NO ACCESS BEYOND THIS POINT
<b>RSMC-DA</b>	DIVERSION AHEAD
<b>RSMC-DL</b>	DIVERSION (LEFT ARROW)
<b>RSMC-DR</b>	DIVERSION (RIGHT ARROW)
<b>RSMC-DTS</b>	DIVERSION (ARROW UP)
<b>RSMC-DE</b>	DIVERSION END
<b>RSMC-DRA</b>	DIVERSION (REVERSIBLE ARROW)

### Plate Only

Code

<b>RSMPO-AO</b>
<b>RSMPO-CLT</b>
<b>RSMPO-CNRM</b>
<b>RSMPO-RIOM</b>
<b>RSMPO-CSE</b>
<b>RSMPO-DDE</b>
<b>RSMPO-DLT</b>
<b>RSMPO-DIPNA</b>
<b>RSMPO-DA</b>
<b>RSMPO-DL</b>
<b>RSMPO-DR</b>
<b>RSMPO-DTS</b>
<b>RSMPO-DE</b>
<b>RSMPO-DRA</b>

ACCESS ONLY

CAUTION LORRIES TURNING

CAUTION NO ROAD MARKINGS

CAUTION RAISED IRONWORKS

CAUTION SITE ENTRANCE

DANGER DEEP EXCAVATIONS

DANGER LORRIES TURNING

DECKING IN PROGRESS NO ACCESS BEYOND THIS POINT

DIVERSION AHEAD

DIVERSION ←

DIVERSION →

DIVERSION ↑















DIVERSION END

DIVERSION ↔

Complete Sign  
(Plate, Frame & Clips)

Code	
RSMC-HPC	HEAVY PLANT CROSSING
RSMC-NA	NO ACCESS
RSMC-NRM	NO ROAD MARKINGS
RSMC-NRL	NEW ROAD LAYOUT AHEAD
RSMC-RA	RAMP AHEAD
RSMC-RAC	ROAD AHEAD CLOSED
RSMC-RACAO	ROAD AHEAD CLOSED ACCESS ONLY
RSMC-RC	ROAD CLOSED
RSMC-SBIP	SLAB POUR IN PROGRESS - NO ACCESS BEYOND THIS POINT
RSMC-SA	SITE ACCESS
RSMC-SIPNA	STRIKING IN PROGRESS - NO ACCESS BEYOND THIS POINT
RSMC-TRS	TEMPORARY ROAD SURFACE
RSMC-TSA	TRAFFIC CONTROL AHEAD
RSMC-TUSC	TRAFFIC UNDER SIGNAL CONTROL
RSMC-WRLSHWH	WHEN RED LIGHT SHOWS WAIT HERE

Plate Only

Code	
RSMPO-HPC	
RSMPO-NA	
RSMPO-NRM	
RSMPO-NRL	
RSMPO-RA	
RSMPO-RAC	
RSMPO-RACAO	
RSMPO-RC	
RSMPO-SBIP	
RSMPO-SA	
RSMPO-SIPNA	
RSMPO-TRS	
RSMPO-TSA	
RSMPO-TUSC	
RSMPO-WRLSHWH	

Frame Only  
Or Blank Plates

Code	
RSMF1075	1050 x 750mm frame only
RSMPO-YLW-10575	Yellow blank plate
RSMPO-RED-10575	Red blank plate

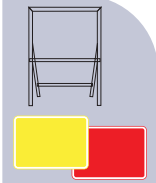

# METAL ROAD SIGNS

## Metal Signs 750mm Triangle

- 750mm triangle
- All signs supplied come with clips
- Pre-riveted available on request at extra cost



### Complete Sign (Plate, Frame & Clips)

Code	
<b>RSMC-MW</b>	MEN AT WORK
<b>RSMC-MWE</b>	MEN AT WORK END
<b>RSMC-RNL</b>	ROAD NARROWS LEFT
<b>RSMC-RNR</b>	ROAD NARROWS RIGHT
<b>RSMC-GW</b>	GIVE WAY
<b>RSMC-HA</b>	HUMPS AHEAD
<b>RSMC-LC</b>	LOOSE CHIPPINGS
<b>RSMC-TLIU</b>	TRAFFIC LIGHT IN USE
<b>RSMC-2WT</b>	TWO WAY TRAFFIC (ARROWS 1 UP, 1 DOWN)
<b>RSMC-SR</b>	SLIPPERY ROAD

### Plate Only

Code
<b>RSMPO-MW</b>
<b>RSMPO-MWE</b>
<b>RSMPO-RNL</b>
<b>RSMPO-RNR</b>
<b>RSMPO-GW</b>
<b>RSMPO-HA</b>
<b>RSMPO-LC</b>
<b>RSMPO-TLIU</b>
<b>RSMPO-2WT</b>
<b>RSMPO-SR</b>



### Frame Only Or With Supplementary

Code	
<b>RSMF750T</b>	750mm triangle frame only
<b>RSMF-SUPP</b>	750mm triangle frame c/w supplementary

**Metal Signs  
600 x 450mm**

- 600 x 450mm
- All signs supplied come with clips
- Pre-riveted available on request at extra cost



**Complete Sign  
(Plate, Frame & Clips)**

Code	
<b>RSMC-FC</b>	FOOTPATH CLOSED
<b>RSMC-FCA</b>	FOOTPATH CLOSED AHEAD
<b>RSMC-FCFD</b>	FOOTPATH CLOSED FOLLOW DIVERSION
<b>RSMC-NP</b>	NO PARKING
<b>RSMC-PAR</b>	PEDESTRIAN ARROW RIGHT
<b>RSMC-PAL</b>	PEDESTRIAN ARROW LEFT
<b>RSMC-PCC</b>	PEDESTRIAN CROSSING CLOSED
<b>RSMC-PPUOF</b>	PEDESTRIANS PLEASE USE OTHER FOOTPATH
<b>RSMC-PA2W</b>	PEDESTRIANS REVERSIBLE ARROW
<b>RSMC-SFAIC</b>	SORRY FOR ANY INCONVENIENCE CAUSED
<b>RSMC-5MPH</b>	5MPH SPEED LIMIT
<b>RSMC-10MPH</b>	10MPH SPEED LIMIT

**Plate Only**

Code	
<b>RSMPO-FC</b>	
<b>RSMPO-FCA</b>	
<b>RSMPO-FCFD</b>	
<b>RSMPO-NP</b>	
<b>RSMPO-PAR</b>	
<b>RSMPO-PAL</b>	
<b>RSMPO-PCC</b>	
<b>RSMPO-PPUOF</b>	
<b>RSMPO-PA2W</b>	
<b>RSMPO-SFAIC</b>	
<b>RSMPO-5MPH</b>	
<b>RSMPO-10MPH</b>	



**Frame Only  
Or Blank Plates**

Code	
<b>RSMF6045</b>	600 x 450mm frame only
<b>RSMPO-YLW-6045</b>	Yellow blank plate
<b>RSMPO-RED-6045</b>	Red blank plate

# METAL ROAD SIGNS

## Metal Signs 750mm Square

- 750mm square
- All signs supplied come with clips
- Pre-riveted available on request at extra cost



### Complete Sign (Plate, Frame & Clips)

Code

**RSMC-AR** BLUE ARROW RIGHT

**RSMC-AL** BLUE ARROW LEFT

**RSMC-ARER** BLUE ARROW REVERSIBLE

**RSMC-AU** BLUE ARROW UP

**RSMC-AUTL** BLUE ARROW UP  
& TO THE LEFT

**RSMC-AUTR** BLUE ARROW UP  
& TO THE RIGHT

**RSMC-NE** NO ENTRY

**RSMC-NLT** NO LEFT TURN

**RSMC-NRT** NO RIGHT TURN

**RSMC-OWAU** ONE WAY ARROW UP

### Plate Only

Code

**RSMPO-AR**

**RSMPO-AL**

**RSMPO-ARER**

**RSMPO-AU**

**RSMPO-AUTL**

**RSMPO-AUTR**

**RSMPO-NE**

**RSMPO-NLT**

**RSMPO-NRT**

**RSMPO-OWAU**



### Frame Only

Code

**RSMF750S** 750mm square frame only

**Metal Signs  
1050 x 450mm**

- 1050 x 450mm
- All signs supplied come with clips
- Pre-riveted available on request at extra cost



**Complete Sign  
(Plate, Frame & Clips)**

Code	
<b>RSMC-RAMP</b>	RAMP
<b>RSMC-SLOW</b>	SLOW
<b>RSMC-DTL</b>	DIVERTED TRAFFIC (ARROW LEFT)
<b>RSMC-DTR</b>	DIVERTED TRAFFIC (ARROW RIGHT)
<b>RSMC-DTRV</b>	DIVERTED TRAFFIC (REVERSIBLE ARROW)
<b>RSMC-DTAU</b>	DIVERTED TRAFFIC (ARROW UP)

Plate Only	
Code	
<b>RSMPO-RAMP</b>	
<b>RSMPO-SLOW</b>	
<b>RSMPO-DTL</b>	
<b>RSMPO-DTR</b>	
<b>RSMPO-DTRV</b>	
<b>RSMPO-DTAU</b>	

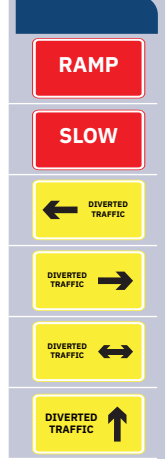

**Frame Only  
Or Blank Plates**

Code	
<b>RSMF1045</b>	1045 x 450mm frame only
<b>RSMPO-YLW-10545</b>	Yellow blank plate
<b>RSMPO-RED-10545</b>	Red blank plate

**Replacement  
Sign Clips**

- For all of our metal road signs



Code	
<b>RSCLIP</b>	

OUTDOOR BINS

**Merlin Bin - Freestanding**

- Plastic liner & lock included
- Hard wearing & durable
- Spare liners, tops & bases available

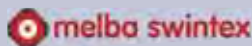

Code

**BINM01**



8

**Osprey Bin - Post Mounted**

- Lid, plastic liner & secure lock included
- Spare liners & lids available
- Post not included

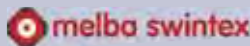

Code

**BIN001**



22

**Doggy Bin - Post Mounted**

- Lid & metal liner included
- Spare liners & lids available
- Post not included

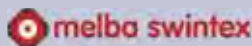

Code

**BIND01**



27

HAVE YOU SEEN?

**AVAILABLE ACCESSORIES**

- BIN POSTS
  - LIDS
  - KEYS
  - BASES & BALLASTS
  - METAL & PLASTIC LINERS
  - PLASTIC BIN BAGS
- and much more

CALL US ON

**020 8311 1144**



# SAFETY SIGNS



Fire Exit & Emergency Signs	482-483
Emergency Signs	484
Site Information Signs	485
Site Signage	486
General Notices	487
Mandatory Signs	488-489
Prohibition Signs	490-491
Construction Site Safety Signs	492
Site Access Signs	493-494
Pedestrian Access Signs	495
Traffic Information Signs	496
Site Hazard Signs	497
Hazard Signs	498-499
General & Site Signs	500-501
Safety Site Boards	502-505
Safety Signs, Posters & Notice Boards	506

## ADD YOUR LOGO TO ANY OF THESE SIGNS

(additional charges may apply)



### ALL YOUR BESPOKE CONSTRUCTION SIGNS PRINTED IN-HOUSE FOR FAST DELIVERY!

Our sign printing machines complement our printed clothing and embroidery services & enable us to provide a complete service for all your sign requirements

#### HERE'S A FEW EXAMPLES OF WHAT WE CAN DO...

- Metal road signs**
- Scaffold protection mesh & banners**
- Labels & stickers**
- Safety signs, safety boards & posters**
- Printed hoardings & site boards**
- ...and much more!**

## CREATE YOUR BESPOKE SIGN

in three simple steps

# 1

Select your required size:

A4	A3	A2	A1	200mm x 600mm	280mm x 90mm	450mm x 150mm
----	----	----	----	---------------------	--------------------	---------------------

# 2

Add all required elements

Include any text, logos or other graphics you need.

**Prohibited**

**Warning**

**Mandatory**

# 3

Call us on **020 8311 1144**

And quote one of the following codes (depending on the size):

BS-PVC-A4 (A4)	BS-PVC-A3 (A3)	BS-PVC-A2 (A2)	BS-PVC-A1 (A1)
BS-PVC-2060 (200 x 600mm)	BS-PVC-289 (280 x 90mm)	BS-PVC-4515 (450 x 150mm)	

# BESPOKE SIGNAGE PRINTED IN-HOUSE FOR NEXT DAY DELIVERY

Choose your layout & we'll do the rest

- METAL ROAD SIGNS
- CORREX SAFETY SIGNS
- PLASTIC SAFETY SIGNS
- PVC SITE SIGNAGE
- CORRUGATED PVC SIGNS
- MANY MORE APPLICATIONS



## CONTACT US FOR ALL YOUR COVID-19 SIGN, STICKER, & BANNER NEEDS



ORDER 6AM TO 7PM FOR NEXT MORNING DELIVERY

Set up an account for our discounted rates / prices

**FIRE EXIT & EMERGENCY SIGNS**



**SSS06** - 150 x 450mm



**SSS05** - 150 x 450mm



**SSS07** - 150 x 450mm



**SSS08** - 150 x 450mm



**SSS03** - 150 x 450mm



**SSS01** - 150 x 450mm

Code      Size

**See above**      150 x 450mm



**FR09424R**  
- 90 x 280mm

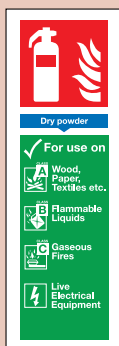

**FR02624R**  
- 90 x 280mm

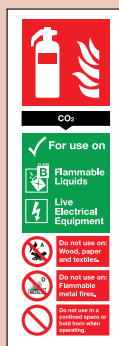

**FR02124R**  
- 90 x 280mm

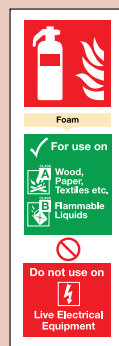

**FR08024R**  
- 90 x 280mm

Code      Size

**See above**      90 x 280mm



Code      Size

**FX05645R**      75 x 600m

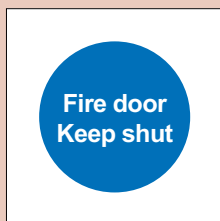

Code      Size

**FR07002R**      100 x 100mm



Code      Size

**FR09951R**      148 x 210mm (A5)



SSS02 - (A2)



SSP253A3 - (A3)  
SSP253A2 - (A2)  
SSP253A1 - (A1)



SSP254A3 - (A3)  
SSP254A2 - (A2)  
SSP254A1 - (A1)



SSP250A3 - (A3)  
SSP250A2 - (A2)  
SSP250A1 - (A1)

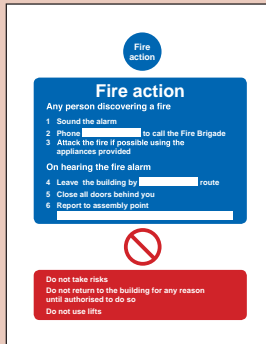

SSP251A3 - (A3)  
SSP251A2 - (A2)  
SSP251A1 - (A1)

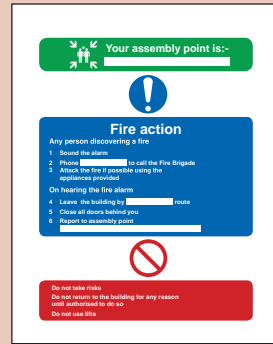

SSP252A3 - (A3)  
SSP252A2 - (A2)  
SSP252A1 - (A1)



SSF01A4 - (A4)  
SSF01A3 - (A3)  
SSF01A2 - (A2)



SSF02A4 - (A4)  
SSF02A3 - (A3)  
SSF02A2 - (A2)



SSF03A4 - (A4)  
SSF03A3 - (A3)  
SSF03A2 - (A2)

Code	Size
See above	210 x 297mm (A4)
See above	297 x 420mm (A3)
See above	420 x 594mm (A2)
See above	594 x 841mm (A1)

## EMERGENCY SIGNS

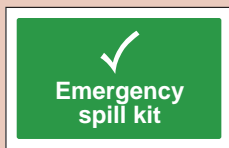

SSS199A3 - (A3)  
SSS199A2 - (A2)  
SSS199A1 - (A1)

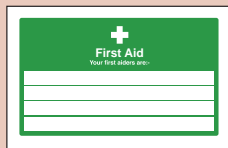

SSSL093A3 - (A3)  
SSSL093A2 - (A2)  
SSSL093A1 - (A1)

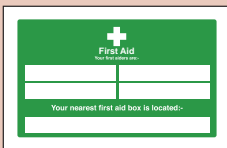

SSS200A3 - (A3)  
SSS200A2 - (A2)  
SSS200A1 - (A1)

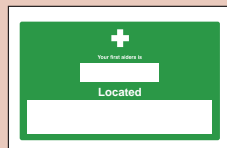

SSS201A3 - (A3)  
SSS201A2 - (A2)  
SSS201A1 - (A1)

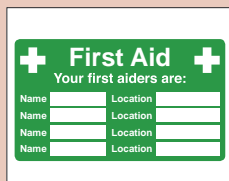

SSS202A3 - (A3)  
SSS202A2 - (A2)  
SSS202A1 - (A1)

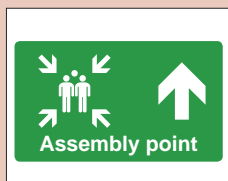

SSS203A3 - (A3)  
SSS203A2 - (A2)  
SSS203A1 - (A1)

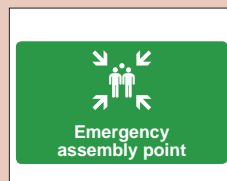

SSS204A3 - (A3)  
SSS204A2 - (A2)  
SSS204A1 - (A1)

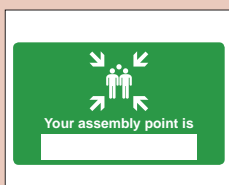

SSS205A3 - (A3)  
SSS205A2 - (A2)  
SSS205A1 - (A1)

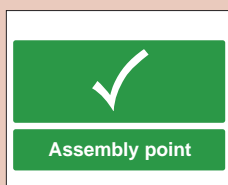

SSS206A3 - (A3)  
SSS206A2 - (A2)  
SSS206A1 - (A1)

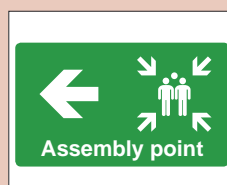

SSS207A3 - (A3)  
SSS207A2 - (A2)  
SSS207A1 - (A1)



SSS208A3 - (A3)  
SSS208A2 - (A2)  
SSS208A1 - (A1)

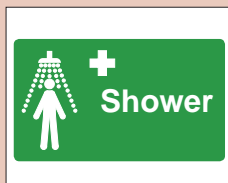

SSS197A3 - (A3)  
SSS197A2 - (A2)  
SSS197A1 - (A1)

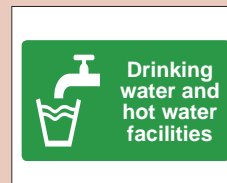

SSS198A3 - (A3)  
SSS198A2 - (A2)  
SSS198A1 - (A1)



SSS083A4 - (A4)  
SSS083A3 - (A3)  
SSS083A2 - (A2)

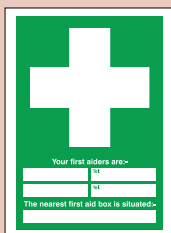

SSS093A4 - (A4)  
SSS093A3 - (A3)  
SSS093A2 - (A2)

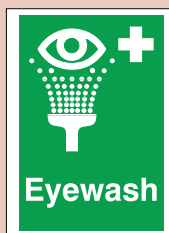

SSS073A4 - (A4)  
SSS073A3 - (A3)  
SSS073A2 - (A2)

Code

Size

See above 210 x 297mm (A4)

See above 297 x 420mm (A3)

See above 420 x 594mm (A2)

See above 594 x 841mm (A1)



**SSS301** - 100 x 150mm



**SSS302** - 100 x 150mm



**SSS303** - 100 x 150mm

Code	Size
------	------

**See above** 100 x 150mm



**SSS234A4** - (A4)  
**SSS234A3** - (A3)  
**SSS234A2** - (A2)



**SSS235A4** - (A4)  
**SSS235A3** - (A3)  
**SSS235A2** - (A2)

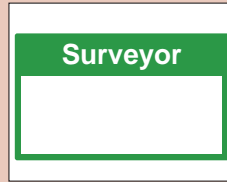

**SSS236A4** - (A4)  
**SSS236A3** - (A3)  
**SSS236A2** - (A2)

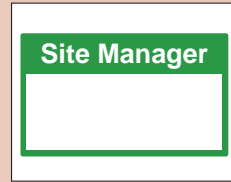

**SSS237A4** - (A4)  
**SSS237A3** - (A3)  
**SSS237A2** - (A2)

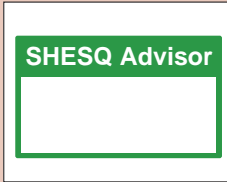

**SSS238A4** - (A4)  
**SSS238A3** - (A3)  
**SSS238A2** - (A2)

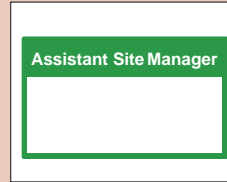

**SSS239A4** - (A4)  
**SSS239A3** - (A3)  
**SSS239A2** - (A2)

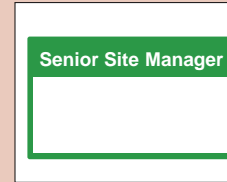

**SSS240A4** - (A4)  
**SSS240A3** - (A3)  
**SSS240A2** - (A2)

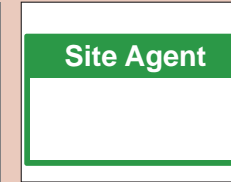

**SSS241A4** - (A4)  
**SSS241A3** - (A3)  
**SSS241A2** - (A2)



**SSS209A4** - (A4)  
**SSG209A3** - (A3)  
**SSG209A2** - (A2)



**SSG210A4** - (A4)  
**SSG210A3** - (A3)  
**SSG210A2** - (A2)

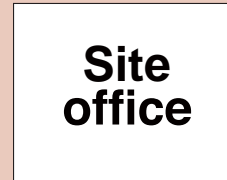

**SSG04A4** - (A4)  
**SSG04A3** - (A3)  
**SSG04A2** - (A2)

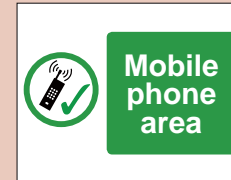

**SSS242A4** - (A4)  
**SSS242A3** - (A3)  
**SSS242A2** - (A2)

Code	Size
------	------

**See above** 210 x 297mm (A4)

**See above** 297 x 420mm (A3)

**See above** 420 x 594mm (A2)

**See above** 594 x 841mm (A1)

**COSHH  
STORES**

SSG212A3 - (A3)  
SSG212A2 - (A2)

**EXTERNAL  
COSHH  
STORES**

SSG213A3 - (A3)  
SSG213A2 - (A2)

**GENERAL  
STORES**

SSG214A3 - (A3)  
SSG214A2 - (A2)

**GENERAL  
WASTE**

SSG07A3 - (A3)  
SSG07A2 - (A2)

**MIXED  
CONSTRUCTION  
WASTE**

SSG215A3 - (A3)  
SSG215A2 - (A2)

**CONTAMINATED  
PACKAGING**  
i.e paint tins/mastic tubes

Empty \_\_\_\_\_  
(12 months from first use/last empty)

SSG216A3 - (A3)  
SSG216A2 - (A2)

**WOOD**

SSG217A3 - (A3)  
SSG217A2 - (A2)

**METAL**

SSG218A3 - (A3)  
SSG218A2 - (A2)

**PAPER**

SSG219A3 - (A3)  
SSG219A2 - (A2)

**Meeting  
room**

SSG230A3 - (A3)  
SSG230A2 - (A2)

**Stores**

SSG231A3 - (A3)  
SSG231A2 - (A2)

**Conference  
room**

SSG232A3 - (A3)  
SSG232A2 - (A2)

**Toilet**

SSG233A3 - (A3)  
SSG233A2 - (A2)

**Gents Toilet**



SSG234A3 - (A3)  
SSG234A2 - (A2)

**Ladies Toilet**



SSG235A3 - (A3)  
SSG235A2 - (A2)

Code

Size

See above 210 x 297mm (A4)

See above 297 x 420mm (A3)

See above 420 x 594mm (A2)

See above 594 x 841mm (A1)





SSS226A3 - (A3)  
SSS226A2 - (A2)  
SSS226A1 - (A1)



SSS227A3 - (A3)  
SSS227A2 - (A2)  
SSS227A1 - (A1)

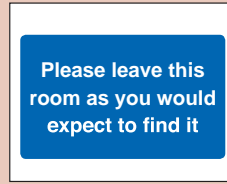

SSM228A3 - (A3)  
SSM228A2 - (A2)  
SSM228A1 - (A1)



SSM229A3 - (A3)  
SSM229A2 - (A2)  
SSM229A1 - (A1)

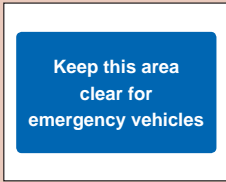

SSM230A3 - (A3)  
SSM230A2 - (A2)  
SSM230A1 - (A1)



SSM231A3 - (A3)  
SSM231A2 - (A2)  
SSM231A1 - (A1)



SSM232A3 - (A3)  
SSM232A2 - (A2)  
SSM232A1 - (A1)



SSM233A3 - (A3)  
SSM233A2 - (A2)  
SSM233A1 - (A1)

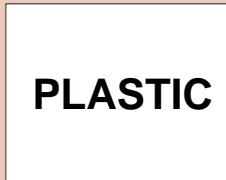

SSG236A3 - (A3)  
SSG236A2 - (A2)

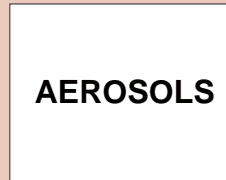

SSG237A3 - (A3)  
SSG237A2 - (A2)

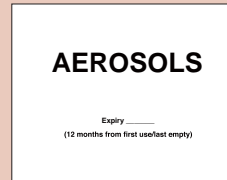

SSG238A3 - (A3)  
SSG238A2 - (A2)



SSG239A3 - (A3)  
SSG239A2 - (A2)

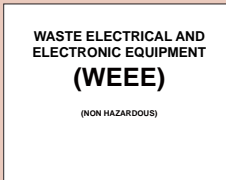

SSG240A3 - (A3)  
SSG240A2 - (A2)

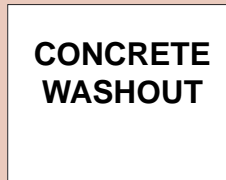

SSG241A3 - (A3)  
SSG241A2 - (A2)



SSG242A3 - (A3)  
SSG242A2 - (A2)



SSG243A3 - (A3)  
SSG243A2 - (A2)

Code	Size
See above	210 x 297mm (A4)
See above	297 x 420mm (A3)
See above	420 x 594mm (A2)
See above	594 x 841mm (A1)



SSM013A4 - (A4)  
SSM013A3 - (A3)  
SSM013A2 - (A2)



SSM06A4 - (A4)  
SSM06A3 - (A3)  
SSM06A2 - (A2)



SSM033A4 - (A4)  
SSM033A3 - (A3)  
SSM033A2 - (A2)



SSM043A4 - (A4)  
SSM043A3 - (A3)  
SSM043A2 - (A2)



SSM053A4 - (A4)  
SSM053A3 - (A3)  
SSM053A2 - (A2)



SSM01A4 - (A4)  
SSM01A3 - (A3)  
SSM01A2 - (A2)



SSM04A4 - (A4)  
SSM04A3 - (A3)  
SSM04A2 - (A2)



SSM093A4 - (A4)  
SSM093A3 - (A3)  
SSM093A2 - (A2)



SSM103A4 - (A4)  
SSM103A3 - (A3)  
SSM103A2 - (A2)



SSM182A3 - (A3)  
SSM182A2 - (A2)  
SSM182A1 - (A1)



SSM184A3 - (A3)  
SSM184A2 - (A2)  
SSM184A1 - (A1)



SSM185A3 - (A3)  
SSM185A2 - (A2)  
SSM185A1 - (A1)

Code

Size

See above 210 x 297mm (A4)

See above 297 x 420mm (A3)

See above 420 x 594mm (A2)

See above 594 x 841mm (A1)



SSM113A4 - (A4)  
SSM113A3 - (A3)  
SSM113A2 - (A2)



SSM123A4 - (A4)  
SSM123A3 - (A3)  
SSMP123A2 - (A2)



Ear protectors  
must be worn  
in this area

SSM083A4 - (A4)  
SSM083A3 - (A3)  
SSM083A2 - (A2)



Hand protection  
must be worn

SSM140A4 - (A4)  
SSM140A3 - (A3)  
SSM140A2 - (A2)



Foot protection  
must be worn

SSM02A4 - (A4)  
SSM02A3 - (A3)  
SSM02A2 - (A2)



Safety  
starts  
here

SSM08A4 - (A4)  
SSM08A3 - (A3)  
SSM08A2 - (A2)



SSM07A4 - (A4)  
SSM07A3 - (A3)  
SSM07A2 - (A2)



Safety helmets  
and protective  
footwear must  
be worn in  
this area

SSM03A4 - (A4)  
SSM03A3 - (A3)  
SSM03A2 - (A2)

Code	Size
See above	210 x 297mm (A4)
See above	297 x 420mm (A3)
See above	420 x 594mm (A2)
See above	594 x 841mm (A1)

## PROHIBITION SIGNS



SSP033A4 - (A4)  
SSP033A3 - (A3)  
SSP033A2 - (A2)



SSP043A4 - (A4)  
SSP043A3 - (A3)  
SSP043A2 - (A2)



SSP053A4 - (A4)  
SSP053A3 - (A3)  
SSP053A2 - (A2)



SSPP060A4 - (A4)  
SSPP060A3 - (A3)  
SSPP060A2 - (A2)



SSP020A4 - (A4)  
SSP020A3 - (A3)  
SSP020A2 - (A2)



SSP03A4 - (A4)  
SSP03A3 - (A3)  
SSP03A2 - (A2)



SSM099A3 - (A3)  
SSM099A2 - (A2)  
SSM099A1 - (A1)



SSP011A3 - (A3)  
SSP011A2 - (A2)  
SSP011A1 - (A1)



SSP187A3 - (A3)  
SSP187A2 - (A2)  
SSP187A1 - (A1)

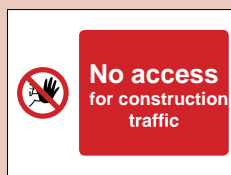

SSP188A3 - (A3)  
SSP188A2 - (A2)  
SSP188A1 - (A1)



SSP189A3 - (A3)  
SSP189A2 - (A2)  
SSP189A1 - (A1)



SSP190A3 - (A3)  
SSP190A2 - (A2)  
SSP190A1 - (A1)

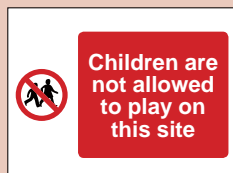

SSP09A3 - (A3)  
SSP09A2 - (A2)  
SSP09A1 - (A1)

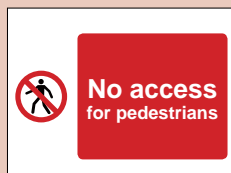

SSP191A3 - (A3)  
SSP191A2 - (A2)  
SSP191A1 - (A1)

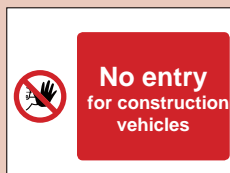

SSP192A3 - (A3)  
SSP192A2 - (A2)  
SSP192A1 - (A1)

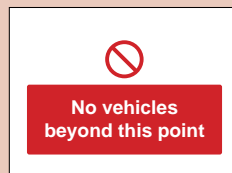

SSP193A3 - (A3)  
SSP193A2 - (A2)  
SSP193A1 - (A1)

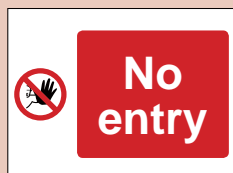

SSP060A3 - (A3)  
SSP060A2 - (A2)  
SSP060A1 - (A1)



SSP194A3 - (A3)  
SSP194A2 - (A2)  
SSP194A1 - (A1)

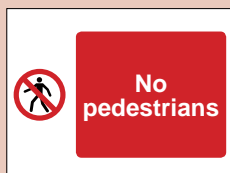

SSP195A3 - (A3)  
SSP195A2 - (A2)  
SSP195A1 - (A1)



SSP03A3 - (A3)  
SSP03A2 - (A2)  
SSP03A1 - (A1)

Code Size

See above 210 x 297mm (A4)

See above 297 x 420mm (A3)

See above 420 x 594mm (A2)

See above 594 x 841mm (A1)



SSP03A3 - (A3)  
SSP03A2 - (A2)  
SSP03A1 - (A1)



SSPL01A3 - (A3)  
SSP01A2 - (A2)  
SSP01A1 - (A1)



SSP196A3 - (A3)  
SSP196A2 - (A2)  
SSP196A1 - (A1)



SSP07A4 - (A4)  
SSP07A3 - (A3)  
SSP07A2 - (A2)



SSP01A4 - (A4)  
SSPP01A3 - (A3)  
SSP01A2 - (A2)



SSP063A4 - (A4)  
SSP063A3 - (A3)  
SSP063A2 - (A2)



SSP30A4 - (A4)  
SSP30A3 - (A3)  
SSP30A2 - (A2)



SSP04A4 - (A4)  
SSP04A3 - (A3)  
SSP04A2 - (A2)

Code	Size
See above	210 x 297mm (A4)
See above	297 x 420mm (A3)
See above	420 x 594mm (A2)
See above	594 x 841mm (A1)

**CONSTRUCTION SITE SAFETY SIGNS**



SSMP101A2 - (A2)  
SSMP101A1 - (A1)



SSW100A2 - (A2)  
SSW100A1 - (A1)



SSW101A2 - (A2)  
SSW101A1 - (A1)



SSW102A2 - (A2)  
SSW102A1 - (A1)

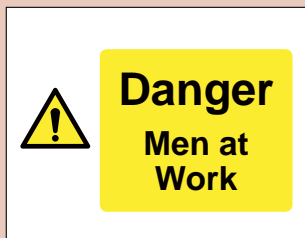

SSW103A2 - (A2)  
SSW103A1 - (A1)



SSW104A2 - (A2)  
SSW104A1 - (A1)



SSG200A2 - (A2)  
SSG200A1 - (A1)

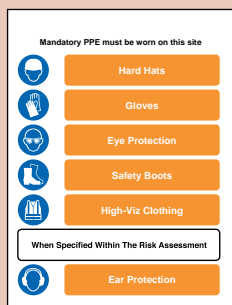

MSR101A3 - (A3)  
MSR101A2 - (A2)  
MSR101A1 - (A1)



MS07646A2 - (A2)  
MS07646A1 - (A1)



MS09500A2 - (A2)  
MS09500A1 - (A1)



MS04100A2 - (A2)  
MS04100A1 - (A1)



SSP105A2 - (A2)  
SSP105A1 - (A1)



SSP106A2 - (A2)  
SSP106A1 - (A1)

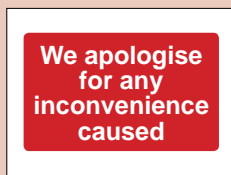

SSP115A2 - (A2)  
SSP115A1 - (A1)



SSP290A2 - (A2)  
SSP290A1 - (A1)

Code	Size
See above	210 x 297mm (A4)
See above	297 x 420mm (A3)
See above	420 x 594mm (A2)
See above	594 x 841mm (A1)



SSP106A2 - (A2)  
SSP106A1 - (A1)



SSP290A2 - (A2)  
SSP290A1 - (A1)



SSP105A2 - (A2)  
SSP105A1 - (A1)



SSP184A2 - (A2)  
SSP184A1 - (A1)



SSP183A2 - (A2)  
SSP183A1 - (A1)



SSP107A2 - (A2)  
SSP107A1 - (A1)

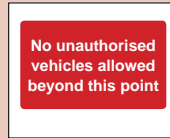

SSP108A2 - (A2)  
SSP108A1 - (A1)

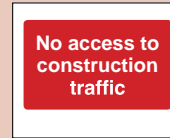

SSP109A2 - (A2)  
SSP109A1 - (A1)

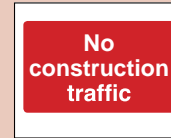

SSP110A2 - (A2)  
SSP100A1 - (A1)



SSP111A2 - (A2)  
SSP111A1 - (A1)

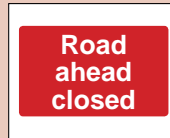

SSP112A2 - (A2)  
SSP112A1 - (A1)

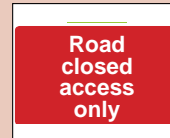

SSP113A2 - (A2)  
SSP113A1 - (A1)



SSP114A2 - (A2)  
SSP114A1 - (A1)



SSP060A2 - (A2)  
SSP060A1 - (A1)

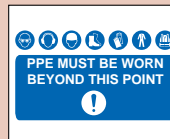

SSMP300A2 - (A2)  
SSMP300A1 - (A1)



SSM116A2 - (A2)  
SSM116A1 - (A1)



SSM117A2 - (A2)  
SSM117A1 - (A1)



SSM118A2 - (A2)  
SSM118A1 - (A1)

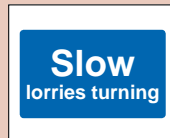

SSM119A2 - (A2)  
SSM119A1 - (A1)



SSM120A2 - (A2)  
SSM120A1 - (A1)



SSM121A2 - (A2)  
SSM121A1 - (A1)



SSM122A2 - (A2)  
SSM122A1 - (A1)

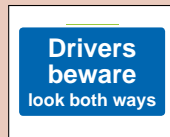

SSM124A2 - (A2)  
SSM124A1 - (A1)



SSM125A2 - (A2)  
SSM125A1 - (A1)



SSM126A2 - (A2)  
SSM126A1 - (A1)

Code	Size
See above	210 x 297mm (A4)
See above	297 x 420mm (A3)
See above	420 x 594mm (A2)
See above	594 x 841mm (A1)

## SITE ACCESS SIGNS



SSP127A2 - (A2)  
SSP127A1 - (A1)



SSP128A2 - (A2)  
SSP128A1 - (A1)

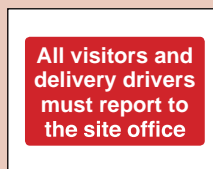

SSP129A2 - (A2)  
SSP129A1 - (A1)

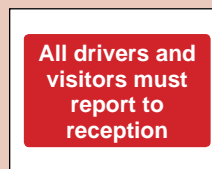

SSP130A2 - (A2)  
SSP130A1 - (A1)

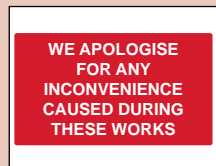

SSP131A2 - (A2)  
SSP131A1 - (A1)

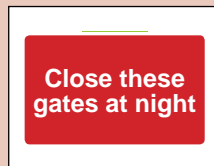

SSP132A2 - (A2)  
SSP132A1 - (A1)

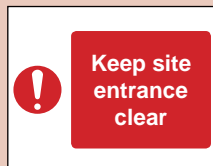

SSP133A2 - (A2)  
SSP133A1 - (A1)

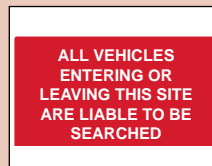

SSP134A2 - (A2)  
SSP134A1 - (A1)

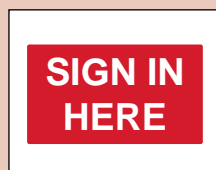

SSP135A2 - (A2)  
SSP135A1 - (A1)



SSP136A2 - (A2)  
SSP136A1 - (A1)

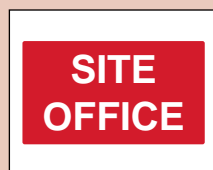

SSP137A2 - (A2)  
SSP137A1 - (A1)



SSP138A2 - (A2)  
SSP138A1 - (A1)

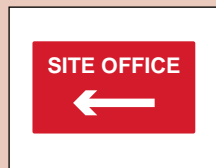

SSP139A2 - (A2)  
SSP139A1 - (A1)

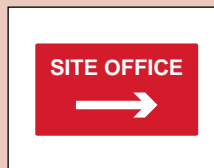

SSP140A2 - (A2)  
SSP140A1 - (A1)



SSP141A2 - (A2)  
SSP141A1 - (A1)



SSP142A2 - (A2)  
SSP142A1 - (A1)



SSP143A2 - (A2)  
SSP143A1 - (A1)



SSP144A2 - (A2)  
SSP144A1 - (A1)



SSP145A2 - (A2)  
SSP145A1 - (A1)

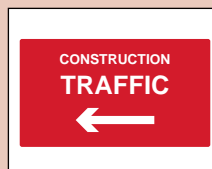

SSP146A2 - (A2)  
SSP146A1 - (A1)

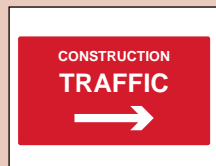

SSP147A2 - (A2)  
SSP147A1 - (A1)



SSP148A2 - (A2)  
SSP148A1 - (A1)



SSP149A2 - (A2)  
SSP149A1 - (A1)



SSP150A2 - (A2)  
SSP150A1 - (A1)

Code Size

See above 210 x 297mm (A4)

See above 297 x 420mm (A3)

See above 420 x 594mm (A2)

See above 594 x 841mm (A1)





SSM123A2 - (A2)  
SSM123A1 - (A1)



SSM151A2 - (A2)  
SSM151A1 - (A1)



SSM152A2 - (A2)  
SSM152A1 - (A1)



SSP152A2 - (A2)  
SSP152A1 - (A1)

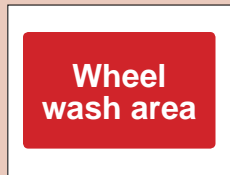

SSP173A2 - (A2)  
SSP173A1 - (A1)

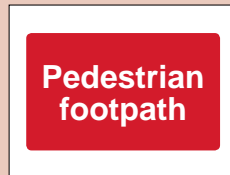

SSP154A2 - (A2)  
SSP154A1 - (A1)



SSP155A2 - (A2)  
SSP155A1 - (A1)

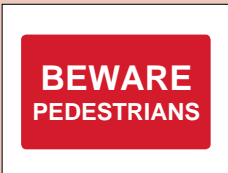

SSP156A2 - (A2)  
SSP156A1 - (A1)

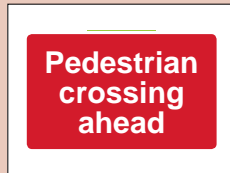

SSP157A2 - (A2)  
SSP157A1 - (A1)

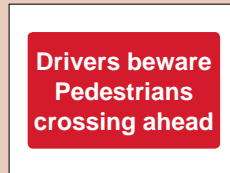

SSP153A2 - (A2)  
SSP153A1 - (A1)



SSP159A2 - (A2)  
SSP159A1 - (A1)



SSP160A2 - (A2)  
SSP160A1 - (A1)



SSP161A2 - (A2)  
SSP161A1 - (A1)



SSP162A2 - (A2)  
SSP162A1 - (A1)



SSP163A2 - (A2)  
SSP163A1 - (A1)

Code	Size
------	------

See above	210 x 297mm (A4)
See above	297 x 420mm (A3)
See above	420 x 594mm (A2)
See above	594 x 841mm (A1)

## TRAFFIC INFORMATION SIGNS



SSP180A3 - (A3)  
SSP180A2 - (A2)  
SSP180A1 - (A1)

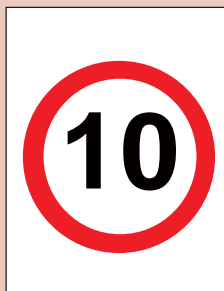

SSP181A3 - (A3)  
SSP181A2 - (A2)  
SSP181A1 - (A1)

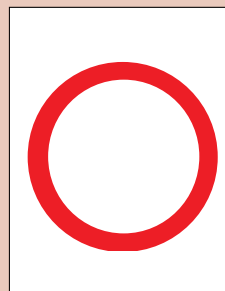

SSP182A3 - (A3)  
SSP182A2 - (A2)  
SSP182A1 - (A1)



SSG220A3 - (A3)  
SSG220A2 - (A2)  
SSG220A1 - (A1)



SSG100A3 - (A3)  
SSG100A2 - (A2)  
SSG100A1 - (A1)



SSG101A3 - (A3)  
SSG101A2 - (A2)  
SSG101A1 - (A1)



SSG221A3 - (A3)  
SSG221A2 - (A2)  
SSG221A1 - (A1)



SSG222A3 - (A3)  
SSG222A2 - (A2)  
SSG222A1 - (A1)



SSG259A3 - (A3)  
SSG259A2 - (A2)  
SSG259A1 - (A1)



SSG223A3 - (A3)  
SSG223A2 - (A2)  
SSG223A1 - (A1)



SSP170A2 - (A2)  
SSP170A1 - (A1)



SSP171A3 - 400 x 300mm  
SSP171A2 - 420 x 594mm (A2)  
SSP171A1 - 800 x 600mm

Code	Size
See above	210 x 297mm (A4)
See above	297 x 420mm (A3)
See above	420 x 594mm (A2)
See above	594 x 841mm (A1)



SSP174A3 - (A3)  
SSP174A2 - (A2)  
SSP174A1 - (A1)



SSP175A3 - (A3)  
SSP175A2 - (A2)  
SSP175A1 - (A1)



SSM176A3 - (A3)  
SSM176A2 - (A2)  
SSM176A1 - (A1)



SSM177A3 - (A3)  
SSM177A2 - (A2)  
SSM177A1 - (A1)



SSM178A3 - (A3)  
SSM178A2 - (A2)  
SSM178A1 - (A1)



SSM179A3 - (A3)  
SSM179A2 - (A2)  
SSM179A1 - (A1)



SSM180A3 - (A3)  
SSM180A2 - (A2)  
SSM180A1 - (A1)



SSM181A3 - (A3)  
SSM181A2 - (A2)  
SSM181A1 - (A1)



SSW168A3 - (A3)  
SSW168A2 - (A2)  
SSW168A1 - (A1)



SSW169A3 - (A3)  
SSW169A2 - (A2)  
SSW169A1 - (A1)



SSW170A3 - (A3)  
SSW170A2 - (A2)  
SSW170A1 - (A1)

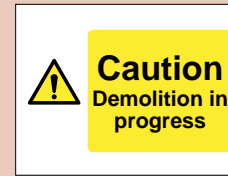

SSW171A3 - (A3)  
SSW171A2 - (A2)  
SSW171A1 - (A1)



SSW172A3 - (A3)  
SSW172A2 - (A2)  
SSW172A1 - (A1)

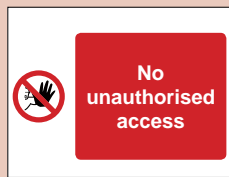

SSP190A3 - (A3)  
SSP190A2 - (A2)  
SSP190A1 - (A1)



SSW173A3 - (A3)  
SSW173A2 - (A2)  
SSW173A1 - (A1)

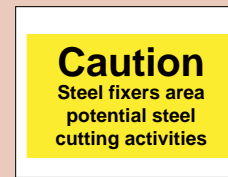

SSW265A3 - (A3)  
SSW265A2 - (A2)  
SSW265A1 - (A1)

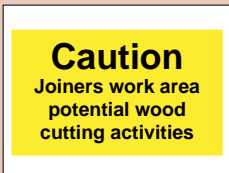

SSW275A3 - (A3)  
SSW275A2 - (A2)  
SSW275A1 - (A1)



SSW221A3 - (A3)  
SSW221A2 - (A2)  
SSW221A1 - (A1)

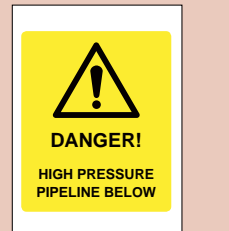

SSW219A3 - (A3)  
SSW219A2 - (A2)  
SSW219A1 - (A1)

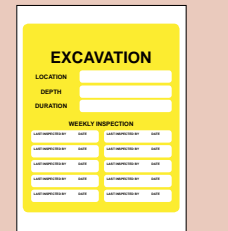

SSW250A3 - (A3)  
SSW250A2 - (A2)  
SSW250A1 - (A1)

Code	Size
See above	210 x 297mm (A4)
See above	297 x 420mm (A3)
See above	420 x 594mm (A2)
See above	594 x 841mm (A1)

## HAZARD SIGNS



SSW02A4 - (A4)  
SSW02A3 - (A3)  
SSW02A2 - (A2)



SSW03A4 - (A4)  
SSW03A3 - (A3)  
SSW03A2 - (A2)



SSW04A4 - (A4)  
SSW04A3 - (A3)  
SSW04A2 - (A2)



SSW05A4 - (A4)  
SSW05A3 - (A3)  
SSW05A2 - (A2)



SSW06A4 - (A4)  
SSW06A3 - (A3)  
SSW06A2 - (A2)



SSW07A4 - (A4)  
SSW07A3 - (A3)  
SSW07A2 - (A2)



SSW09A4 - (A4)  
SSW09A3 - (A3)  
SSW09A2 - (A2)

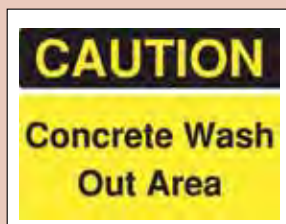

SSW10A4 - (A4)  
SSW10A3 - (A3)  
SSW10A2 - (A2)



SSW11A4 - (A4)  
SSW11A3 - (A3)  
SSW11A2 - (A2)



SSW13A4 - (A4)  
SSW13A3 - (A3)  
SSW13A2 - (A2)



SSW14A4 - (A4)  
SSW14A3 - (A3)  
SSW14A2 - (A2)

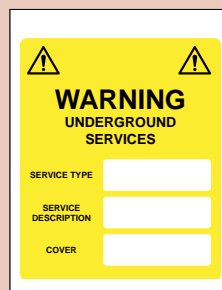

SSW222A1 - (A1)  
SSW222A2 - (A2)

Code	Size
See above	210 x 297mm (A4)
See above	297 x 420mm (A3)
See above	420 x 594mm (A2)
See above	594 x 841mm (A1)



SSW15A4 - (A4)  
SSW15A3 - (A3)  
SSW15A2 - (A2)



SSW16A4 - (A4)  
SSW16A3 - (A3)  
SSW16A2 - (A2)

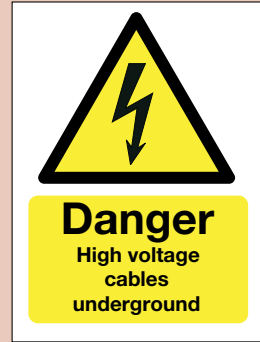

SSD03A4 - (A4)  
SSD03A3 - (A3)  
SSD03A2 - (A2)



SSW01A4 - (A4)  
SSW01A3 - (A3)  
SSW01A2 - (A2)



SSW08A4 - (A4)  
SSW08A3 - (A3)  
SSW08A2 - (A2)



SSW099A4 - (A4)  
SSW099A3 - (A3)  
SSW099A2 - (A2)



SSD05A4 - (A4)  
SSD05A3 - (A3)  
SSD05A2 - (A2)



SSW20A4 - (A4)  
SSW20A3 - (A3)  
SSW20A2 - (A2)



SSD04A4 - (A4)  
SSD04A3 - (A3)  
SSD04A2 - (A2)

Code	Size
See above	210 x 297mm (A4)
See above	297 x 420mm (A3)
See above	420 x 594mm (A2)
See above	594 x 841mm (A1)



SSMP01A4 - (A4)  
SSMP01A3 - (A3)  
SSMP01A2 - (A2)



SSMP02A4 - (A4)  
SSMP02A3 - (A3)  
SSMP02A2 - (A2)

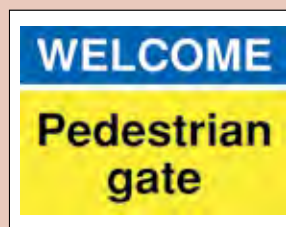

SSMP03A4 - (A4)  
SSMP03A3 - (A3)  
SSMP03A2 - (A2)



SSMP04A4 - (A4)  
SSMP04A3 - (A3)  
SSMP04A2 - (A2)

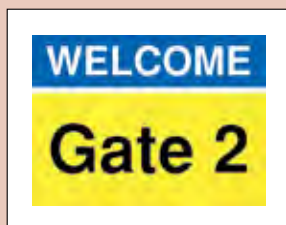

SSMP05A4 - (A4)  
SSMP05A3 - (A3)  
SSMP05A2 - (A2)

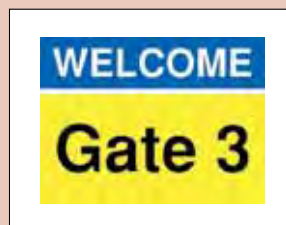

SSMP06A4 - (A4)  
SSMP06A3 - (A3)  
SSMP06A2 - (A2)



SSMP07A4 - (A4)  
SSMP07A3 - (A3)  
SSMP07A2 - (A2)



SSMP08A4 - (A4)  
SSMP08A3 - (A3)  
SSMP08A2 - (A2)



SSMP10A4 - (A4)  
SSMP10A3 - (A3)  
SSMP10A2 - (A2)



SSMP11A4 - (A4)  
SSMP11A3 - (A3)  
SSMP11A2 - (A2)



SSG06A4 - (A4)  
SSG06A3 - (A3)  
SSG06A2 - (A2)

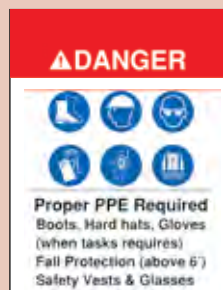

SSMP09A3 - (A3)  
SSMP09A2 - (A2)  
SSMP09A1 - (A1)

Code	Size
See above	210 x 297mm (A4)
See above	297 x 420mm (A3)
See above	420 x 594mm (A2)
See above	594 x 841mm (A1)



SSMM01 - 200mm x 600mm



SSMM02 - 200mm x 600mm

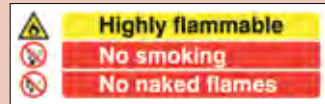

SSMM03 - 200mm x 600mm

Code	Size
See above	200 x 600mm



SSG01A3 - (A3)  
SSG01A2 - (A2)  
SSG01A1 - (A1)



SSG02A3 - (A3)  
SSG02A2 - (A2)  
SSG02A1 - (A1)



SSG03A3 - (A3)  
SSG03A2 - (A2)  
SSG03A1 - (A1)

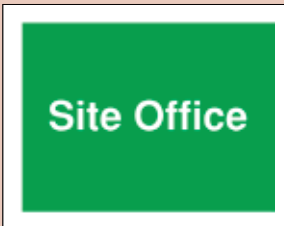

SSGG04A3 - (A3)  
SSGG04A2 - (A2)  
SSGG04A1 - (A1)

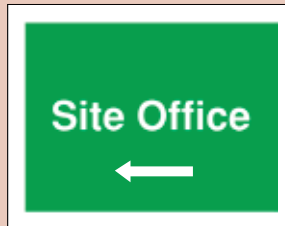

SSG04LA3 - (A3)  
SSG04LA2 - (A2)  
SSG04LA1 - (A1)

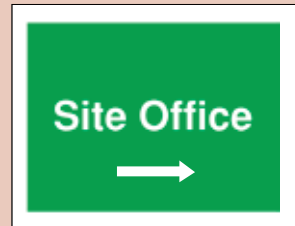

SSG04RA3 - (A3)  
SSG04RA2 - (A2)  
SSG04RA1 - (A1)



SSG05A3 - (A3)  
SSG05A2 - (A2)  
SSG05A1 - (A1)



SSM201A3 - (A3)  
SSM201A2 - (A2)

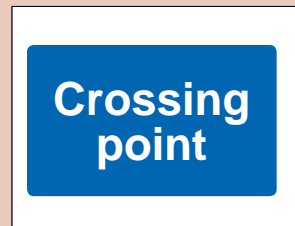

SSM200A3 - (A3)  
SSM200A2 - (A2)

Code	Size
See above	210 x 297mm (A4)
See above	297 x 420mm (A3)
See above	420 x 594mm (A2)
See above	594 x 841mm (A1)

## SITE SAFETY BOARDS

 **Site safety**

 **Warning  
Dangerous Site**

 **Hard hats, boots and  
hi-visibility waistcoats  
must be worn**

 **All visitors to this  
site must report to  
site office**

 **No unauthorised  
access**

 **Children should not  
play on this site**

HA28333A2 - (A2)  
HA28346A1 - (A1)

 **Site safety**

- The Health and Safety at Work Act 1974 requires all persons who enter this site to comply with the regulations of this act.
- All visitors **MUST** report to the site office and obtain permission before proceeding or working on this site, or at any work area.
- Safety signs and procedures **MUST** be complied with at all times. Personal protection and safety equipment **MUST** be used at all times on this site.

 **Construction work is in progress and  
can be dangerous.  
Parents are advised to warn their  
children of the dangers of entering  
this site.**

 **Safety helmets  
must be worn**

 **Unauthorised entry to  
this site is strictly  
forbidden.**

HA28133A2 - (A2)  
HA28146A1 - (A1)

 **Site safety**

 **Warning  
Dangerous work  
in operation**

 **All visitors  
must report to the  
site office**

 **Safety helmets  
must be worn**

 **Unauthorised access  
prohibited**

HA20433A2 - (A2)  
HA20446A1 - (A1)

**SITE SAFETY NOTICE**

 **Unauthorised entry to this  
site is strictly prohibited**

 **WARNING CONSTRUCTION IN PROGRESS  
Parents are advised to warn children of the  
dangers of entering construction sites**

 **1. All visitors must report to the site office.  
2. Permission must be obtained before entering the site or any work area.  
3. Safety signs and procedures must be observed.  
4. Personal protection and safety equipment must be used at all times.  
5. All persons entering this site must comply with the regulations under the  
Health and Safety at Work Act 1974.**

 **Safety helmets  
must be worn**

 **Safety footwear  
must be worn**

MS06133A2 - (A2)  
MS06133A1 - (A1)

Code	Size
See above	210 x 297mm (A4)
See above	297 x 420mm (A3)
See above	420 x 594mm (A2)
See above	594 x 841mm (A1)





MS00536A4 - (A4)  
MS00536A3 - (A3)  
MS00536A2 - (A2)



MS01036A4 - (A4)  
MS01036A3 - (A3)  
MS01036A2 - (A2)

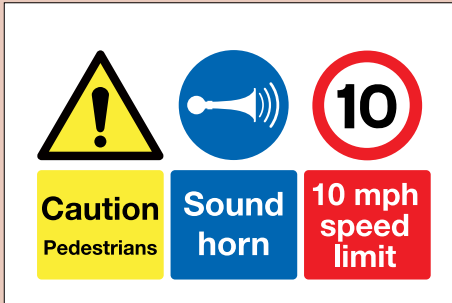

MS00936A4 - (A4)  
MS00936A3 - (A3)  
MS00936A2 - (A2)



MS02729A4 - (A4)  
MS02729A3 - (A3)  
MS02729A2 - (A2)



MS01529A4 - (A4)  
MS01529A3 - (A3)  
MS01529A2 - (A2)



MS03329A4 - (A4)  
MS03329A3 - (A3)  
MS03329A2 - (A2)

Code	Size
See above	210 x 297mm (A4)
See above	297 x 420mm (A3)
See above	420 x 594mm (A2)
See above	594 x 841mm (A1)

# SITE SAFETY BOARDS

SITE SAFETY	
All visitors and drivers must report to site office	Children must not play on this site
Construction work in progress. Parents are advised to warn children of the dangers of entering this site	High visibility jackets must be worn
Report all accidents immediately	<b>Danger</b> Deep excavations
Safety helmets are provided for your safety and must be worn	<b>Danger</b> Stop, Look, Listen. Beware of trucks
Protective footwear must be worn	No access for unauthorised personnel

MM097A2 - (A2)

MM097A1 - (A1)

SITE SAFETY	
Construction work in progress. Parents are advised to warn children of the dangers of entering this site	<b>Danger</b> Demolition work in progress
No admittance for unauthorised personnel	Use ear protectors
This is a hard hat area	High visibility jackets must be worn
Protective footwear must be worn	<b>Warning</b> Look out for overhead loads

MM096A2 - (A2)

MM096A1 - (A1)

SITE SAFETY	
	<b>Heavy plant and machinery operate on this site</b>
	Vehicles must not enter this site without authority of the site supervisor. Unsupervised reversing in and out is strictly forbidden
	<b>Speed and parking restrictions must be observed</b>

MM095A2 - (A2)

MM095A1 - (A1)

	<b>WARNING</b> This building site is dangerous. Parents are advised to warn children of the consequences of entering and playing on this site
	<b>Strictly no admittance to unauthorised personnel</b>
	<b>Safety helmets must be worn on this site at all times</b>
	<b>All visitors and drivers must report to site office</b>

MM087A2 - (A2)

MM087A1 - (A1)

Site safety	
All visitors must report to site office	High visibility jackets must be worn in this area
All accidents must be reported immediately	Protective footwear must be worn
Wear hard hats	<b>Warning</b> Deep excavations
Dangerous site, parents are advised to warn their children of the dangers of entering this site	<b>Warning</b> Heavy plant and machinery operate on site
Unauthorised entry to this site is strictly forbidden	Children must not play on this site

MS06041A2 - (A2)

MS06041A1 - (A1)

Site safety	
Dangerous site, parents are advised to warn their children of the dangers of entering this site	<b>Danger</b> Demolition in progress
Safety helmets must be worn	Ear protectors must be worn
Unauthorised entry to this site is strictly forbidden	High visibility jackets must be worn
Protective footwear must be worn	<b>Warning</b> Overhead loads

MS07646A2 - (A2)

MS07646A1 - (A1)

Code	Size
See above	210 x 297mm (A4)
See above	297 x 420mm (A3)
See above	420 x 594mm (A2)
See above	594 x 841mm (A1)



MM098A2 - (A2)  
MM098A1 - (A1)



MM105A2 - (A2)  
MM105A1 - (A1)

Code	Size
See above	210 x 297mm (A4)
See above	297 x 420mm (A3)
See above	420 x 594mm (A2)
See above	594 x 841mm (A1)

# CALL US FOR ALL COVID-19 SIGNAGE

# CALL US

FOR ALL YOUR CUSTOM ROAD SIGN REQUIREMENTS

PRINTED IN-HOUSE FOR FAST DELIVERY!



**FIRST AID AT WORK**

➤ **ASSURE THE SITUATION** ➤ **ASSESS THE SEVERITY OF THE INJURY**

**PROBLEM ➤ ACTION TO TAKE**

**BREATHING**

**UNCONSCIOUSNESS**

**SEVERE BLEEDING**

**SUSPECTED BROKEN BONES**

**BURNS AND SCALDS**

**CHEMICAL BURNS**

**EYES**

**ELECTRIC SHOCK**

**GLASSING**

WC61A2 - (A2)

**ELECTRIC SHOCK EMERGENCY RESUSCITATION**

**Check Casually**

**Resuscitate if Necessary**

**Commence CPR**

WC140A2 - (A2)

**SCAFFOLD SAFETY**

**GENERAL RULES**

**Check**

**Remember**

WC108A2 - (A2)

**Noise at work - Do You Know All You Need to Know?**

Under The Control of Noise at Work Regulations 2005, both employers and employees have obligations which they must fulfil to minimise the risk of damage to hearing at the workplace. Below is a summary of these obligations - you must comply.

EMPLOYERS DUTIES	Apply	As far as is reasonably practicable	As far as is reasonably practicable
1. Assess the noise risk to health in the workplace	✓	✓	✓
2. Control the noise risk to health in the workplace	✓	✓	✓
3. Provide information, instruction and training to employees	✓	✓	✓
4. Provide health surveillance to employees	✓	✓	✓
5. Provide access to hearing protection to employees	✓	✓	✓
6. Provide access to quiet areas to employees	✓	✓	✓
7. Provide access to earplugs to employees	✓	✓	✓
8. Provide access to earmuffs to employees	✓	✓	✓
9. Provide access to earplugs to employees	✓	✓	✓
10. Provide access to earmuffs to employees	✓	✓	✓
11. Provide access to earplugs to employees	✓	✓	✓
12. Provide access to earmuffs to employees	✓	✓	✓
13. Provide access to earplugs to employees	✓	✓	✓
14. Provide access to earmuffs to employees	✓	✓	✓
15. Provide access to earplugs to employees	✓	✓	✓
16. Provide access to earmuffs to employees	✓	✓	✓
17. Provide access to earplugs to employees	✓	✓	✓
18. Provide access to earmuffs to employees	✓	✓	✓
19. Provide access to earplugs to employees	✓	✓	✓
20. Provide access to earmuffs to employees	✓	✓	✓

FWC31A2 - (A2)

**REPORTING OF INJURIES, DISEASES AND DANGEROUS OCCURRENCES REGULATIONS**

**Reporting of Injuries, Diseases and Dangerous Occurrences Regulations 1995**

**Reporting of Injuries, Diseases and Dangerous Occurrences Regulations 2013**

**Reporting of Injuries, Diseases and Dangerous Occurrences Regulations 2013**

WC153A2 - (A2)

**THE CONSTRUCTION (DESIGN AND MANAGEMENT) REGULATIONS 1994**

**THE HEALTH AND SAFETY EXECUTIVE**

WC142A2 - (A2)

Code **See above** Size **420 x 594mm (A2)**

**Health and Safety Law What you need to know**

**Who's responsible for your health and safety?**

**What you need to know**

**What you need to do**

**What you need to know**

Code **AFWC30RP** Size **1mm PVC 420 x 594mm (A2)**

Code **AFW30LA2** Size **Laminated 420 x 594mm (A2)**

Code **AFW30LA3** Size **Laminated 297 x 420mm (A3)**

3M Dust Masks	312			Brooms	74, 75
<b>A</b>		<b>B</b>		Broom Handles	75
Abrasive Discs	40,41	Balaclava	368	Broom Handle Clamps	75
Absorbent Sock	228	Ballistic Trousers	365	Bubble Wrap	143, 178
Accident Report Book	248	Band Stands	141	Buck Boots	272, 273, 275
Access Podium	434, 444	Barrel Pump	138	Buckets	77, 78, 219
Acoustic Barriers	235, 236	Barrier Cream	194, 195, 197, 209	Buddha Barrier	455
Acro Props	141	Barrier Tape	145, 179	Builders Trestles	141
AdBlue	428	Barro Box	161	Bulk Bags	139
Adjustable Spanners	98	Baseball Cap	368	Bull Nose Trowel	88-91
Adjustable Steel props	141	Bastard File	97	Bunting	145, 461
Adjustastairs	435	Batteries	174, 465	Burn Kits	247
Adjustable Folding Stairs	435	Beaded Hand Gel	209	Butt Hinges	399
Air Compressor	429	Beam Cart	160	<b>C</b>	
Air Freshener	208	Beanie Hat	368	C-Fold Towels	213
Air Horn	256	Belle Wheelbarrow	71	C-Fold Towel Dispenser	213
All Steel Forks	55	Bib & Brace - Hi Vis	348, 355, 356	Cable & Hose Protector Ramp	458
All Steel Rakes	55, 67	Big Blue Concrete Float	405	Cable Management Hooks	169
All Steel Rammers	55	Biodegradable	204-205, 240, 241	Cable Reels	164, 165
All Steel Shovels	52, 54	Cleaning Products		Cable Ties	168, 179
Allen Key Sets	99	Biodegradable Cups	223, 244	Canteen Bench	185
Aluminium Dapple Bars	419	Biodegradable Cutlery	223	Canteen Cannister Set	220
Alphabloc Barrier	455	Bin Liners	215	Canteen Tables	185
Aluminium Spazzle	69, 405	Bit Holders	386,387	Carbon Discs	40,41
Aluminium Lightweight Stagings	438	Bitukold Emulsion - Hand applied	125	Car Interior Wipes	210
Anti-Bacterial Hand Gel	191, 198	Bitukold Spray	125	Car Mats	430
Anti-Bacterial Hand Soap	209	Bitumen Cleaner & Degreaser	125	Car Seat Cover	430
Anti-Bacterial Wipes	210,	Bituseal Spray	125	Car Wash & Wax	430
Anti-Freeze	428	Bleach	206	Carborundum Stone	97
Anti Skid Sheets	124	Blow Out Pump	42, 388	Carpenters Pencils	105
Anti-vibration Gloves	288	Blue Roll	213	Carpet Protection Roll	178
Antiseptic Cleaning Wipes	248	Boat Level	93	Carpet Tiles	180
Applicator Gun For Foam	134	Body Warmer - Hi Vis	341, 358	Caulk	133
Aprons	199	Boiler Suits	366	Cement Mixer	419
Aquapax Water	221, 243	Bolle Safety glasses	300-302, 306	Centre Feed Roll	213
Arc Flash Clothing	370, 376-382	and goggles		Centre Feed Roll Dispenser	213
Arc Protected Boots	266, 267	Bolsters	92	Centurion Hard Hats	323
Armbands - COSS	248	Bolt Croppers	103	Ceramic Bowls	223
Armbands - First Aider	248	Bookcase	187	Ceramic Mug	223
Armlets With Inserts	360	Boots	260-275	Ceramic Plates	223
Asbestos Sacks	215	Boot Bag	270	Chain	145, 157
Ash Handled Fork	56	Boot Cleaner	217, 226	Chain Barrier System	463
Ash Handled Rake	57, 67	Boot Wash	226	Chairs - Office	188
Ash Handled Shovels	52, 56	Bow Saw	95	Chairs - Stacking	188
Ash Handled Shov-Holer	57	Bowls	223	Chalk Line & Chalk	126
Ash Tray	184	Breaker Points & Chisels	420	Chalk Refill	126
Asphalt Road Repair	125	Breaker Steels	420	Chartwell Survey Book	122
Asphalt Release Agent	123	Breakaway Cable	426	Chemical Anchor Resin	390-393
Auger Bits	44	Brick & Patio Cleaner	208	Chemical Anchor Studs	388
Automotive Supplies	428-430	Brick Jointer	91	Chest Waders	274
Auto Retract Safety Knife	96	Brick Line	126	Chin Straps	326
Avalon Barrier	452	Brick Trowels	88-90	Chipping Hammer	87
		Brightboots	272, 273	Chisel & Point crowbar	55, 59, 66
		Brogues safety shoes	270		

Chisels	92	Cup Grinding Discs	36	Drain Test Kit & Pump	154
Chlorine	225	Curly Top Pins	148	Drawing Storage Trolleys	182
Chukka Boot	265, 268	Curing Tank	406	Drill Bits	42-45
Chuck Adaptor	387	Cut Resistant Gloves	286, 287, 290, 291	Drill Chucks	387
Chucks - Drill	387	Cut Resistant Sleeves	287	Drinking Cups	244
Churn brush	217	Cutlery	222, 223	Drinking Water	221, 242, 243
Circular Saw Blades	50	Cutting Discs	40, 41	Drip Trays	230, 231
Claw Hammer	86	<b>D</b>		Drivers Gloves	284
Clock	184	Damp Proof Membrane	140	Drop in Wedge Anchors	395
Clocking-In System	184	Dapple Bars	419	Drum Pallet Sump	230
Club Hammer	86	Dealer Boots	268	Dry Core Drills	37
Cobra Rodding System	142	De-Icer	83, 428	Drywall Screws	385
Coco Door Mat	217, 226	DEB Products	196, 197	Dry Wipe Board	182
Coffee	220	Debris Netting	140	Dry Wipe Pens	183
Coiled Connection Lead	427	Deck Scrub	218	Drywall Screws	385
Colas Bitukold	125	Decorators Caulk	133	Duct Tape	144, 179
Colas Bitumen Colspray	125	Defibrillator	249-251	Dumpy Bags	139
Colas Leoclean	125	Denso Tape	407	Dusmo Sweeping Compound	208
Cold Asphalt Road Repair	125	Descaler	207	Dust Bins	214,
Cold Chisel	92	Desks	186	Dust Extractor	416
Colour Coded Gloves	286, 287, 290, 291	Desk Pedestals	186	Dust Masks	309, 312, 313
Combination Ladders	440	Detectable Underground	149	Dust Sheet	131, 141, 177
Combination Pliers	102, 104	Warning Tape		Dust Suppression Water Bottle	79, 80
Combination Spanners	98	Detectamesh	149	Dusters	211
Compressor Hose	150	Detonators & Cases	360	Dustpan & Brush	217
Concrete Accessories	402-410	Diamond Blades	16-35	<b>E</b>	
Concrete Broom	74, 405	Diamond Cores	37, 38	Ear Defenders	292-295
Concrete Curing Compound	408	Diesel Cans	137, 138	Ear Defenders - Helmet Mounted	293, 295
Concrete Curing Tank	406	Digital Keypad Lock	155, 400	Ear Defenders - Neckband	294
Concrete Finishing Broom	74, 405	Digital Thermometers	202, 406	Ear Plugs	296, 297
Concrete Mixer	419	Dish Cloths	211	Ear Plug - Dispenser	296
Concrete Placer	69, 405	Dishwasher	225	Easytack Primer	123
Concrete Rubbing Brick	97	Dishwasher Salt	225	ECO Friendly	204-205, 240, 241
Concrete Scoop	403	Dishwasher Tablets	225	Cleaning Products	
Concrete Thermometer	406	Disinfectant	206	ECO Friendly Cups	223, 244
Concreting Gloves	280, 285	Disinfectant Wipes	199, 210	ECO Friendly Cutlery	223
Cones	462-464	Disposable Coveralls	367	Ecoviz ECO Friendly Polo Shirts	339
Cone Signs	466-468	Disposable Gloves	289	Edge Protection	177
Confined Space Tripod	329	Door Mats	217	Edging Trowels	90
Connector Nuts	396	Door Jam Protector	176	End Cutters	103, 407
Copier Paper	184	Double Sided Tape	144, 179	Envirohorn Drain Filter	233
Core Drills	37, 38	DPM	140	Enviropad Oil retention Mat	233
Correx Sheeting	141, 177	Drain - Air Bag Stoppers	153	EVOSpec Helmet Mounted Eyeshield	324
COSHH Store	158	Drain Brush	152	Expandable Safety Barrier	453
Coveralls - Disposable	367	Drain Cleaning Wheel	154	Expanding Foam	134
Coveralls -	373, 374, 378, 381	Drain Double Worm Screw	152	Extension Ladders	439
Flame Retardant & ARC Protected		Drain Filter - Envirohorn	233	Extension Leads	164, 165
Coveralls - Plain Colours	366	Drain Plunger	152	Eye Protection	298-306
Coveralls - Hi Vis	348, 355-357	Drain Rod Set	152	Eye Pod Stations	249
Cream Cleaner	207	Drain Stoppers	153	Eyewash Stations	249
Crowbars	55, 59,	Drain Stopper Nipples & End caps	153	<b>F</b>	
Cupboard	187	Drain Test dye	152	Face Fit Testing Kit	315
Cups	222, 223, 244	Drain Test Hose	154		
Cup Sleeves	222				

Face Fit Testing Kit Solution	315	Forecourt Auto Wipe	212	Haemmerlin Wheelbarrow	72
Face Mask Filters	316, 317	Forma-store	158	Hammer Fixings	394
Face Masks - Respirators	309, 312, 313	Form Face Retarder	408	Hammers	76, 86, 87
Face Masks Surgical	200-202	Form Release Agent	408	Hand Brush	217
Face Masks Type 11R	200-202	Formwork Oil Sprayer	82, 409	Hand Cleaner	194-197
Face Masks - 3 Ply	200-202	Fridge	225	Hand Cleaner dispenser	194-197
Faceshields	202, 306,	Frost Blanket	406	Hand Reconditioner	194-197
Face Visors	202, 306,	Frost Protection Foam Blanket	406	Hand Held Spray Bottle	81
Fairy Liquid	206	Fuel Cans	137, 429	Hand Signalman Kit	359
Fall Arrest Equipment	328-330	Funnels	138	Hand Soap	205, 209
Fall Restraint Equipment	328-330	Furniture Polish	207	Hand Staple Gun	104
Fans	173	<b>G</b>		Hand Tampers	420
Fan Heaters	172, 173	Gaffa Tape	144, 179	Handsaws	94
Fencing Gate	447, 450	Galvanised Buckets	77, 78, 219	Hand Sanitiser Gel	191, 198
Fencing Pins	148	Galvanised Mop Buckets	77, 219	Hand Sanitiser Gel- Bulk refill packs	191
Festoon Lighting	167, 168	Galvanised Tar Buckets	77, 78	Hand Sanitiser Gel Dispensers	190
FFP3V Masks	309, 312, 313	Galvanised Tar Cans	78	- Manual	
Files	97	Gas Cage	160	Hand Sanitiser Gel Dispensers	190, 191
Filing Cabinet	187	Gas Hose	106	- Touch Free	
Fire Alarms	256, 257	Gas Lance & Torch	106	Hand Sanitiser Gel Site Stations	192
Fire Bell	257	Gas Lance & Torch kit	106, 123	Hand Sanitiser Spray	198
Fire Blanket	256	Gas Regulator	106	Hard Hat Accessories	324-327
Fire Bucket	256	Gas Torch	106	Hard Hats	320-325
Fire Extinguishers & Accessories	254-258	Gate Barriers	452	Hardboard	176
Fire Extinguisher Stands	255, 258	Gate Hinge	399	Hardpoint saws	94
Fire Hose	257	Gauging Trowels	88-90	Harnesses	328-330
First Aid & Coss Armband	248	Gauntlets	285	Hasp & Staple	155, 399
First Aid Kits	246, 247	Glass Cleaner Spray	204, 207	Hat & Coat Stand	184
First Aid Plasters	248	Glass Paper	132	Hazardous Storage Boxes	159, 160
Fisco Tape Measure	118, 119	Glass Scraper	131	Hawk	88
Flags & Poles	360	Glass, Window	204, 207	Head Torches	166
Flambank Storage	159, 160	& Stainless Steel Cleaner		Hearing Protection	292-297
Flame Retardant & Arc clothing	370-382	Gloves	279-291	Heaters	172, 173
Flashing Beacons	465	Goal Post System	460	Helmets	320-325
Flat Bits	44	Goggles	305, 306	Helmet Lights	326
Fleece Jackets - Plain Colours	364	Gorilla Gas Cage	160	Helmet Liners	327
Fleece Jackets - Hi Vis	341	Gorilla Tub	77	Helmet Mounted Eyeshield	324
Flexi Tub	77	Gowns	199	Helmet Stickers	326
Floats	88	Grass Seed	78	Henry Vacuum Cleaner	216
Flood Lights	167, 168, 170	Grease cartridge	97	Henry Vacuum Cleaner Bags	216
Floor Cleaner	208	Grease Gun	97	Hessian Roll	143
Floor Saw	423	Green Rhino spillage products	222-234	Hessian Sandbags	139
Floor Scraper	96	Green Skip Net	139	HexArmor Sharpmaster Gloves	288
Floor Scraper blades	96	Grinding Discs	41	Hex Head Bolts	397
Flooring Trowels	88-91	Gripfill Adhesive	132	Hex Nuts	398
Fluorescent Lighting	168, 170, 171	Grip Gloves	279, 286, 290	Hilti Gun Nails	384
Fluorescent Tubes	168, 171	Grit Bins	84, 214	Hinges	399
Fly Leads	164	Gully Bowl	57	Hi-Tensile Sockets	101, 395
Fly & Wasp Spray	208	Gum Remover	208	Hi Vis Clothing	335-358
Foam Gun Cleaner	134	<b>H</b>		Holdall Bags	334
Folding Rule	122	Hacksaw	95	Hog Barrier	455
Foot Pump	429	Hacksaw Blades	95	Hole Punch	183
Footprint Wrench	102			Hole Saws	46
Force 8 Respirators	316			Hooded Sweatshirt - Plain Colours	363

## INDEX (H-N)

Hooded Sweatshirt - Hi Vis	343	Kentucky Mops	219	Lubricant Spray	136
Hoodie - Hi Vis	340	Kentucky Ringer Bucket	219	Lump Hammer	86
Hop Up Platform	440	Kerb Lifter	76	Lute	69
Hose - Compressor	150	Kerb Ramps	456	<b>M</b>	
Hose - Contractors	150	Kettle	224	Magnet	100
Hose Clips	151	Key Cabinet	155	Maintenance Platforms	436, 437
Hose Fittings	151	Keypad Lock	155	Mallets	76, 87
Hot Water Urn	224	Key Tags	155	Manhole Keys	154
HSS Drill Bits	45	Kitbag	334	Marking Crayons	121
Hushtec Barriers	235, 236	Knapsack Backpack Sprayer	81	Marker Paint	120, 121
Hushtec Phone box	237	Kneepads	369	Marker Pens	183
Hushtec Rock Breaker Attachment	238, 239	Knife blades	96	Masking Tape	131, 144, 179
Hygiene Roll	212	Knife - Retractable blade	96	Matting - Cellular	162
<b>I</b>		Knife - Stanley	96	Matting - Rubber	162
ICE Holder	326	Knit Wrist Gloves	285	Matting - Hi vis	162
Ice Scraper	428	<b>L</b>		Mattocks	67
Impact Sockets	101, 395	Ladies Footwear	271	Mauls	76
In Case Of Emergency Holder	326	Ladies Clothing - Hi Vis	351	Maximum-Minimum Thermometer	406
Indent Roller	403	Ladders	439-441	Melba Buddha Barrier	455
Industrial Hand Cleaner	194-197	Laddertag Kits	433	Measuring Wheel	118
Inflator Pumps	154	Lane Divider Barriers	455	Mesh Fencing	149
Infrared Heaters	173	Lanyards - Scaffolders	328	Metal cutting discs	40,41
Ink & Gum Remover	208	Lanyards - Tool tethering	112, 113	Metatarsal Protection boots	261, 265
Insoles	270	Lanyards - Fall Arrest	328, 330	Footwear	260-275
Insta-Deck	432	Laser Levels	122	Metal Road Signs	472-477
Instagate Barrier	453	Latex Gloves	279, 280, 286, 290	Microfibre Cloths	211
Insulated Forks	63	- General handling		Microwave	224
Insulated Punner	65	Latex Gloves - Disposable	289	Milk	221
Insulated Shovels	53, 60-65	Lawn Rake	68	Minibar Beacons	465
Insulated Shov-Holer	63	Leads - Extension	164, 165	Mineral Water	242, 243
Insulation Tape	144	Leads - 110V	164, 165	Mini Magnet	100
Irwin 880 Hand Saw	94	LED Lighting	167, 170, 171	Mini Mobile Scaffold	432
<b>J</b>		Lens Cleaning Solution	307	Mixing Paddle	130
Jackets - Flame Retardant & ARC Protected	377, 380	Lens Cleaning Station	307	Mobile Hand Wash Stations	193
Jackets - Plain Colours	364	Lens Cleaning Wipes	307	Mole Grips	102
Jackets - Hi Vis	343-346, 351, 357, 358	Levels - Spirit	93	Moldex Dust masks	312
Jam Protector	176	Level Crossing Attendant Kit	359	Monarflex	140
J-Cloths	211	Level Crossing Lamps	360	Monarflex Toggles	140
Jerricans	138	Lifting Straps	146	Mop Buckets	219
Jerry Cans	138	Lighting	167-171	Mops & Buckets	219
Jet Stream Powered Air Respirator	318	Light Bulbs	169, 171	Mortar Mixing Tray	78
Jigsaw Blades	50	Line Marker Spray	120, 121	Mortar Tub	78
Jizer Bio	208	Line Marking Roll	124	Mould Oil	408
Jockey Wheels & Accessories	427	Line Pins	126	Mugs	223
Jubilee Clips	151	Linesman Harness	326	Multi Fix Bolts	396
Jumbo Roll	213	Liquid Descaler	207	Multi Purpose Saw	94
Jumbo Roll Dispenser	213	Liquid Hand Soap	205, 209	Multitool Blades	48,49
Jump Leads	428	Litter Picker	218	Multi Surface Cleaner	204, 206
Jute Tarmac Sheets	143	Lockers	185	Mushroom Caps	142, 410
<b>K</b>		Longlife Milk	221	<b>N</b>	
		Long Nose Pliers	102, 104	Nail Brush	209
		Lookout Kit	359	Nails	384
		Low Tack Tape	179		



Needle disposal kits	252	Pickaxes	66, 67	Q-Signs	470, 471
Needle Resistant Gloves	288	Pick Heads & Handles	66, 67	Quilted Tarmac Sheets	143
Neoprene Wellington Boots	272, 273, 275	Pin Boards	182	<b>R</b>	
Nitrile Gloves	281, 282, 286	Pipe Grease	97	Radiators - Oil Filled	172
- General handling		Pipe Cutters	106	Rags	211
Nitrile Gloves - Disposable	199, 289	Pipe Slice	106	Rail Vests - Hi Vis	353
No Waiting Cones	464	Pipe Wrench	102, 104	Rakes	68, 404
Non-Conductive Road Pins	148	Plan Hangers	182	Rammers	55, 65
Non-Conductive Fence Pins	148	Plant Nappys	230	Ratchet Handle	101
Note Book	184	Plasters	248	Ratchet Straps	146
Notice Boards	182	Plasterers Hawk	88	Rawl Plugs	385
Numatic Vacuum Cleaner	216	Plastic Chain	145, 157, 463	Rebar Safety Strip	410
Numatic Vacuum Cleaner Bags	216	Plastic Cups	222	Reciprocating Saw Blades	47
<b>O</b>		Plastic Cutlery	222	Red & White Bunting Tape	145, 461
Office Chairs	188	Plastic Key Tags	155	Reflective Strip For Temporary Fencing	448
Office Desks	186	Plastic Sleeved Chain	157	Refuse Sacks	215
Office Shirts	363	Plates	222, 223	Release Agent	408
Office Stapler	184	Plate Compactors	421, 422	Resin	392-395
Oil & Sediment Filter	234	Platform Ladders	443	Respiratory Protection	308-319
Olympus Dust Masks	313	Pliers	102, 104	Respirators - Disposable	309, 312, 313
Optime Ear defenders	294, 295	Plugging Chisel	92	Respirators - Half Mask	316, 317
Orange Mesh Fencing	149	Pointing Trowels	88-90	Respirators - Full Face	317
Orange Skipper Unit	145, 463	Pole Ladders	441	Respirators - Jetstream	318
Outdoor Bins	478	Polo Shirts - Flame Retardant & Arc Protected	372, 379, 382	Respirators - Powercap Infinity	319
Overbanding Tape	124	Polo Shirts - Plain Colours	361, 362	Retractable blade knife	96
<b>P</b>		Polo Shirts - Hi Vis	339, 340, 351, 354	Retractable blade knife blades	96
Pad Saw	95	Polyfibre Fork	59	Richard Carter Shovels	60, 64, 65
Padlocks	156, 157, 400	Polyfibre Shovels	53, 58-60	Rigger Boots	269
Padlock Bolt	399	Polypropylene Rope	142	Rigger Gloves	284
Paint Brushes	128	Polypropylene Sandbags	139	Rinse Aid	225
Paint Kettle	130	Polystyrene Cups	222	Road Cones & Accessories	464-464
Paint Roller Extension Pole	129	Portable Aluminium Stairs	435	Road Marking Paint	120, 121
Paint Roller Set	129	Portable Truck Access Stairs	434	Road Measuring Wheel	118
Paint Roller Sleeves	129	Post Hole Spade	55, 63, 65	Road Pins	148
Paint Scuttle Set	130	Power Tools	414, 415	Road Signs	466-477
Paintbuster Wipes	130, 210	Powercap Infinity	319	Rock Salt	84
Pallet Sump	230	- Powered air respirator		Rope	142
Pallet Truck	73	PPE Recycling	314	Round Mouth Shovel	54
Paper	184	Prescription Safety Eyewear	298, 299	Rot Proof Sandbags	139
Paper Hand Towel Dispenser	212, 213	PressToCheck Respirators	316	Rotary Fire Bell	257
Paper Hand Towels	212, 213	Pressure Washers	416	Rotating Beacon	465
Paper Plates	222	Profile Boards	149	Rotating Laser Kit	122
Path Boards	456	Propane Regulator	106	Rubber Gloves	285
Paving Maul	76	PTFE Tape	144	Rubber Mallet	76, 87
PDU Drive Unit	419	PU Gloves	283, 286, 287, 290, 291	Rubber Maul	76
Pedestals - Office	186	Pump - Submersible	418	Rubbing Brick	97
Pedestrian Barriers	450	Puncture Repair Kit	429	Rubble Sacks	215
Pencils - Carpenters	105	Punner	55, 65	Rubble Truck	161
Pencils - Office	105, 183	PVC Knit Wrist Gloves	285	Rucksacks	334
Pens - Ballpoint	183	PVC Pipe Cutter	106	<b>S</b>	
Permanent Markers	183	<b>Q</b>		Sack Truck	73
Petrol Cans	137, 429	Qualitative Face Fit Test	315	Safegate Barrier	453

## INDEX (S-T)

Safekerb Ramp	456	Shov Holer	55, 57, 63	Spring Water	242, 243
Safety Chest Waders	274	Shrink Wrap	143, 178	Squeegee	69
Safety Footwear	260-275	Side Cutters	103, 104	Stacking Chairs	188
Safety Glasses/Spectacles	298-306	Silicone Cartridges	133	Staff for Laser level	122
Safety Goggles	305, 306	Silicone Gun	133	Stainless Steel Cleaner	207
Safety Gloves	279-291	Silicone Spray	136	Stainless Steel Cutlery	222
Safety Posters	506	Silver Foil Tape	144	Stairs	435
Safety Signs	478-506	Site Boxes	159	Stair Protector Roll	176
Safety Specs Neck Cords	306	Site Fire Alarm	256, 257	Standpipe Hose	150
Safety Trainers	269	Site Lighting	167-171	Standpipe Keys	154, 257
Salopettes - Hi Vis, Flame Retardant & Waterproof	355	Site Safety Boards	502-506	Standpipe & Accessories	154, 257
Salopettes - Hi Vis & Waterproof	348, 356	Site Safety Stations	192, 193, 258	Stanley Knife	96
Salt Bins	84	Site Table	185, 187	Stapler - Office	184
Salt Spreader	84	Skin Care Safety Centre	195	Staple Gun	104
Sandbags	139	Skin Reconditioner	194-197	Staples	104, 184
Sandpaper Disks	132	Skip Net	139	Steel Cupboard	187
Sandpaper Roll	132	Skipper Unit	145, 463	Steel Props	141
Sanitising Gel	191, 198	Skip Net	139	Steel Strapping	147
Saws	94, 95	Skyworker Helmet	322	Steel Tape	119
Scafftags	433	Sledge Hammers	76	Step Up Platform	440
Scaffold Nipple Caps	142	Sleeve Anchors	395	Step Ladders	442
Scaffold Spanner	98	Slump Cone	403	Stepover Ladders	436
Scaffold Towers	432, 433	Smoke Alarm	256	STIHL Saws	424, 425
Scaffold Tube End Caps	142	Snow Shovel	83	STIHL Two Stroke Oil	137
Scissors	183	Soap bars	209	Stillson Wrench	104
Scouring Pads	211	Soap - Hand	205, 209	Stockinette Gloves	289
Scrapers	96, 131	Socket Drives	101	Stopcock Key	154, 257
Scraper - Paint	131	Socket Set	100	Stop & Go Handheld Signs	464
Scraper - Glass	131	Socks	270	Storage Vault	159, 150
Scraper - Floor	96	Softshell Jackets - Plain Colours	364	Storm Coat - Hi Vis	343, 345, 357
Screen De-icer	83	Softshell Jackets - Hi Vis	341, 358,	Strapping Combination Tool	147
Screen Prop	177,	Solvent Cleaner	134	Strapping Kit	147
Screenwash	83, 428	Sonis Ear Defenders	292, 293	Strapping Seals	147
Screws	385	Spades	54, 55, 59, 63, 65	Stringlines	126
Screwdriver Bits	386	Spanners	98	Strong Grip	132
Screwdriver Sets	99	Spazzles	69, 405	Studding	396
Scutch Hammer	87	Spear Bit Drills	45	Submersible Pumps	418
SDS Drill Bits	42, 43	Speed Humps	458	Sugar	220
SDS Points & Chisels	43	Speed Hump Fixing Bolts	458	Sun Cream & Lotion	197, 226
Sealant Gun	133	Spillage Granules	229	Super Maintenance Platforms	436, 437
Seat Covers	430	Spill Kits	228, 229	Surgical Gowns	199
Security Chain	157	Spill Pads	229	Survey Book	122
Securasite Fencing	446-448	Spill Socks	228	Swarfega	209
Sediment Dewatering Filter	234	Spirit Levels	93	Sweatband for helmet	326
Self Drilling Screws	394	Splitter Boxes - 110v	165	Sweatshirts - Flame Retardant & Arc Protected	372, 379
Set Screws	397	Sponges	211	Sweatshirts - Plain Colours	363
Setting Out Pegs & Profile Boards	149	Spray Adhesive	132	Sweatshirts - Hi Vis	340, 354
Setting Punch For Wedge Anchor	395	Spray Bottles	81	Sweeping Compound	208
Sharps Disposal Bins	252	Spray Paint - Road marking	120	Swing Bin	214
Sharps Kits	252	Spray Paint - Spot marking	121	Swing Bin Liners	215
Shirts	363	Spray Paint Applicators	121		
Shoe Covers	367	Sprayer Lance	81		
Shovels	53-65	Sprayers	81, 82, 409		
		Spring Cleaning Kit	208		

## T

T-Hinge 399

Tables - Canteen	185	Traffic Film Remover	430	Washboy Bucket	77,
Tables - Office	187	Trailer Parts	426, 427	Washers	398
Tack Mat	178	Trailer Light Board	426	Washing Up Bowl & Brush	223
Tamper Rammer	55, 65	Trailer Number Plate Clips	426	Washing Up Brush	223
Tamping Bar	403	Trainers	269	Washing Up Liquid	205, 206
Tamping Rod	403	Transbank Hazardous transit boxes	160	Waste Paper Bin	182, 215
Tape Measures	118, 119	Transformers - 110v	165	Water	221
Tar Brushes	105	Trench Cover	456	Water Bottle - Dust suppression	79, 80
Tar Buckets	77, 78	Tripod - Confined Space	329	Water Bottle - Plastic with lid	80
Tar Cans	78	Trousers - Flame Retardant & Arc Protected	373, 376-381	Water Butt	78
Tarmac Lute	69	Trousers - Jogging Hi Vis	342, 343	Water Containers	80
Tarmac Rammer	55, 65	Trousers - Polycotton Plain Colours	365, 366	Water Dispenser	221
Tarmac Steels	420	Trousers - Polycotton Hi Vis	342, 343, 351, 356	Water Pump Pliers	102
Tarmac Sheets - Jute	143	Trousers - Waterproof Plain Colours	349	Water Sprayers	81
Tarmac Sheets - Quilted	143	Trousers - Waterproof Hi Vis	346-348, 355	Watering Cans	78
Tarpaulins	139	Trowels	88-91	WD40	136
TCT Circular Saw Blades	50	Truck Access Stairs	434	Wedge Anchors	395
Tea Bags	220	Truck Loading Podiums	434	Welders Gauntlets	288
Tea Towels	211	T-Shirts - Plain Colours	361-362	Wellington Boots	272-275
Telescopic Ladder	439, 440	T-Shirts - Hi Vis	337, 339, 354	Womens Footwear	271
Telescopic Screen Prop	177,	Turntable Truck	161	Wet Floor Signs	218
Telescopic Staff	122	Two Stroke Oil	137, 138	Wet Suits	346-349
Temporary downpipe	177	Two Way Radio	184	Wet Weather Clothing	344-349, 357
Temporary Fencing	446-448	Tying Wire	407	Wheelbarrows	70-73
Temporary Fencing Accessories	448	Typhoon Dust Masks	313	Wheelie Bins	214
Temporary Protective Sheeting	177,	<b>U</b>		Wheelie Bin Bags	215
Test Cube Moulds	402	Underground Warning Tape	149	Wheelie Bin Liners	215
Test Cube Tamping Bar	403	Uplights	171	Whipcheck	150
Thermal Gloves	279, 280	Urinal Blocks	207	Whistles	155
Thermometers - Concrete	406	Urinal Screen	207	White Board	182
Thermometers - Infrared	202	Urn	224	White Board Eraser	183
Thermometers - Max/Min	406	Utility Barrier	453	White Copier Paper	184
Thermoplastic Line Marking Roll	124	Uvex Dust Masks	312	White Spirit	130
Thigh Waders	274	UVEX Safety Specs & Goggles	304, 305	Window Cleaner Spray	204, 207
Thinsulate Liner For Pulsar Coveralls	355	<b>V</b>		Window Film	178
Threaded Bar	396	Vacuum Cleaners	216	Wipes	198, 210
Through Bolts	395	Van first aid kit	246	Wire Brushes	105
Tile Drills	36, 45	Van Seat Cover	430	Women's Footwear	271
Tin Snips	103	Verge Posts	464	Wood Screws	385
Tipp-Ex Pen	183	Vests - Hi Vis	335-337, 353	Wooden Cutlery	223, 244
Titan Barrier	452	Vests - Hi Vis Rail Spec	353	Wooden Float	88
Toasters	224	Vinyl Gloves - Disposable	199, 289	Wooden Maul	76
Toilet Brush & Holder	218	Visilite	326	Workplace First Aid Kits	247
Toilet Cleaner	205, 207	Visors & Carriers	306, 324	Workshop Wipes	210
Toilet Tissue	212, 213	Vistalens	325	Wrecking Bar	92
Toilet Tissue Dispenser	212, 213	Vistashield	325	<b>Y</b>	
Tonne Bag	139	<b>W</b>		Yellow Dusters	211
Tool Box	104	Wall Mounted Ash Tray	184	<b>Z</b>	
Tool Tethering	107-116	Warning Beacons	465	Z-Fold Towels	212, 213
Top Face Retarder	408	Warning Chain	145, 463	Zebra Tape	145, 179
Torch & Aspects	359				
Torches	166, 359				
Torches - Head	166				
Tow Ball & Pin Hitch	426				
Traffi-Gloves	286, 287, 290, 291				
Traffic Management	451-477				

**OPEC DIAMOND BLADES & CORES**  
**CUTTING & DRILLING**  
**GROUNDWORK TOOLS**  
**HAND TOOLS**  
**TOOL TETHERING**  
**MEASURING & SURVEYING**  
**EQUIPMENT**  
**DECORATING & SEALANTS**  
**SITE EQUIPMENT**  
**ELECTRICAL & LIGHTING**  
**SITE PROTECTION**  
**SITE FURNITURE & STATIONERY**  
**COVID HYGIENE**  
**JANITORIAL & CATERING**  
**ENVIRONMENTAL**  
**FIRE, ACCIDENT & EMERGENCY**  
**PERSONAL PROTECTIVE**  
**EQUIPMENT**  
**HI VIS CLOTHING**  
**& WORKWEAR**  
**FIXINGS & FASTENERS**  
**CONCRETE & FORMWORK**  
**ACCESSORIES**  
**PLANT, POWER TOOLS**  
**& AUTOMOTIVE**  
**SAFESMART ACCESS**  
**SECURASITE**  
**TRAFFIC MANAGEMENT**  
**SAFETY SIGNS**



# CMT

## EQUIPMENT

Everything you need to site - **FAST!**



**GET IT NOW! -**  
**2 HOUR VIP**  
**DELIVERY SERVICE**  
**WITHIN M25 & KENT**



**GET IT TOMORROW AM!**  
**ORDERS PLACED BY 7PM WILL BE**  
**DELIVERED BEFORE NOON THE**  
**NEXT DAY ANYWHERE IN UK**



Crown  
 Commercial  
 Service  
 Supplier

